

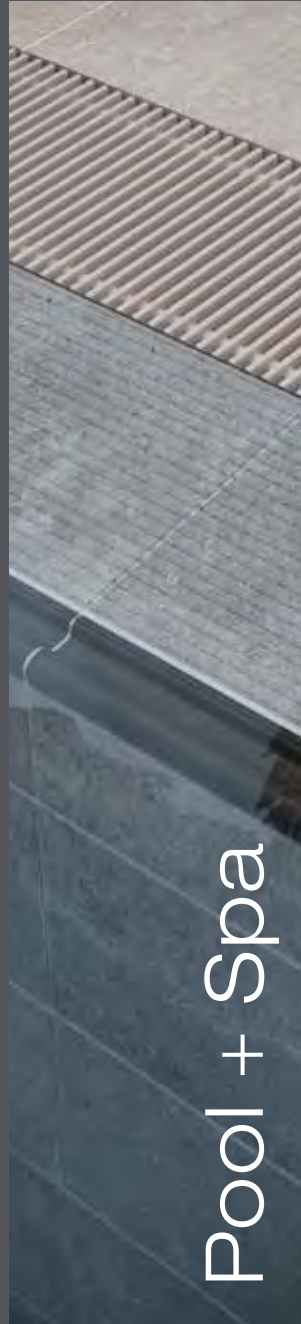

Project



Pool + Spa



Living

Programme of Delivery

2023

Overview of all series in
alphabetical order

architectural
ceramics

Series	Page
Alcina	460
Amano	40
Area Pro	44
Ascona	72
Aruba	472
Basic Stone	86
Basis 1/1+ 2 3 4	90
Basis 1	480
Bliss	488
Basis Pro	100
Cedra	492
Ceramic channel cover 2.0	450
Chroma	114, 338
Chroma non-slip	124, 348
Chroma unglazed	134, 356
Como	500
Concrete	504
Craft	142
Craft Extended	150
District	154
Eladuct + Keraion ELA	158
Emotion	162
Emotion Grip	172
Evalia	510
Ferrum	178
Focus Royal	518
Fresh	182
Jasba-CLARA	524
Jasba-PATTERN	528
Jasba-RONDA	536
Jasba-SENJA PURE	540
Jasba-VILLAGE	546
Jasba-NIVELLA	550
Karl	196
KerAion Spec. Glazes for Operat. Theatres	202
Kiano	554
La Casa	562
Like	568
Lounge	578
Loop	206
Lunar	586
Mandalay	590
Mando	594
Marble & More	216
Modern White	600
Natural Ceramics	220
New Market	228
Nova	234
Oak	606
Orientation aids for the blind	108
Pizarro	612
Plural	244
Plural non-slip	264
Plural unglazed	272
Plural Kids	278
Pool edge systems	362
Quarzit	284
Savona	292
Sento	616
Sierra	626
Sky	632
Solid Rock	636
Soul	646
Stories	652
Streetlife	298
Surf	304
Swimming pool accessories – Outlets and cover gratings	448
Swimming pool special pieces	424
Timeless	662
Trias	312
Unique	318
Urban Cotto	668
Valley	324
Walden	672

Project

Introduction	4 – 23
Product finder	24 – 29

Amano	40 – 43
Area Pro	44 – 71
Ascona	72 – 85
Basic Stone	86 – 89
Basis	90 – 99
Basis 1	93 – 94
Basis 1+	95
Basis 2	96
Basis 3	97 – 98
Basis 4	99
Basis Pro	100 – 107
Orientation Aids for the Blind	108 – 113
Chroma	114 – 123
Chroma non-slip	124 – 133
Chroma unglazed	134 – 141
Craft	142 – 149
Craft Extended	150 – 153
District	154 – 157
Eladuct + Keraion ELA	158 – 161
Emotion	162 – 171
Emotion Grip	172 – 177
Ferrum	178 – 181
Fresh	182 – 195
Karl	196 – 201
KerAion Special Glazes for Operating Theatres	202 – 205
Loop	206 – 215
Marble & More	216 – 219
Natural Ceramics	220 – 227
New Market	228 – 233
Nova	234 – 243
Plural	244 – 263
Plural non-slip	264 – 271
Plural unglazed	272 – 277
Plural Kids	278 – 283
Quarzit	284 – 291
Savona	292 – 297
Streetlife	298 – 303
Surf	304 – 311
Trias	312 – 317
Unique	318 – 323
Valley	324 – 329















Pool + Spa

Introduction	332 – 337
Product finder	30 – 33

Chroma	338 – 347
Chroma non-slip	348 – 355
Chroma unglazed	356 – 361
Pool edge systems –	362 – 367
System solutions in swimming pool construction	
Overview	364 – 367
Finland	368 – 373
Finland II	374 – 379
Wiesbaden, elevated water level	380 – 383
Wiesbaden Silent	384 – 385
Wiesbaden with mosaic recess	386 – 387
Wiesbaden Stil	388 – 391
Wiesbaden, decreased water level	392 – 395
Wiesbaden, therapy pools	396 – 399
Bamberg	400 – 403
St. Moritz	404 – 407
Berlin	408 – 411
Zürich	412 – 415
Skimmer	416 – 419
Pool edging tiles	420 – 423
Skirtings,	424 – 429
Profiled edgings	430 – 431
Grooved tiles	432 – 437
Special tiles	438 – 447
Swimming pool accessories – Outlets and cover gratings	448 – 449
Ceramic channel cover 2.0	450 – 453
Cover gratings	454 – 455
Outlets	456 – 457

Living

Introduction	4 – 23
Product finder	34 – 37

Alcina 	460 – 471
Aruba 	472 – 479
Basis 1	480 – 487
Bliss	488 – 491
Cedra 	492 – 499
Como	500 – 503
Concrete 	504 – 509
Evalia 	510 – 517
Focus Royal	518 – 523
Jasba-CLARA	524 – 527
Jasba-PATTERN	528 – 535
Jasba-RONDA	536 – 539
Jasba-SENJA PURE	540 – 545
Jasba-VILLAGE	546 – 549
Jasba-NIVELLA	550 – 553
Kiano	554 – 561
La Casa 	562 – 567
Like	568 – 577
Lounge 	578 – 585
Lunar 	586 – 589
Mandalay 	590 – 593
Mando	594 – 599
Modern White	600 – 605
Oak	606 – 611
Pizarro 	612 – 615
Sento	616 – 625
Sierra 	626 – 631
Sky	632 – 635
Solid Rock	636 – 645
Soul 	646 – 651
Stories	652 – 661
Timeless 	662 – 667
Urban Cotto	668 – 671
Walden 	672 – 675

Index/Technical Information

Article numbers	678 – 691
Models	692 – 693
Model numbers	694 – 695
Classification according to NCS/RAL Lightness values	696 – 697
Luminance contrast	698 – 700
Technical Information	701 – 719
World-wide distribution network	720 – 721
Comments	723

We understand. Since 1755.



Reliable

We know a lot about tiles. We have been working with clay since 1755 and have a comprehensive understanding of our material and the production of highest-quality stoneware, porcelain stoneware and earthenware. In our four German production facilities, we are constantly refining our recipes for mixing clay, feldspar, fireclay, kaolin and water. As a natural material which transitions from plastic to solid in carefully monitored firing processes, clay offers endless possibilities for creating ceramic products that help make architecture durable, sustainable and beautiful.



Versatile

Our products are used far and wide. Indoors and outdoors. From private homes to museums. From hotels to hospitals. From restaurants to offices. From shops to swimming pools. From bathroom floors to building facades. We offer floor, wall and facade tiles for every purpose. And we produce all kinds of special elements to meet almost any specific requirement, whether it's a special piece for a swimming pool or an integrated orientation aid for visually impaired people. Our tiles can be found everywhere, world-wide.

Cooperative

No matter how good our products are, we believe that only their application brings out their qualities. That's why we value collaboration and are happy to share our knowledge to find the best solution for each of your architectural projects. Where our standard products reach their limits, we develop customized solutions. Special productions are our speciality. We have the expertise and experience to support architects from the invitation to bid to the project completion. Tell us how we can help you. Contact us if you want to hear what we know.

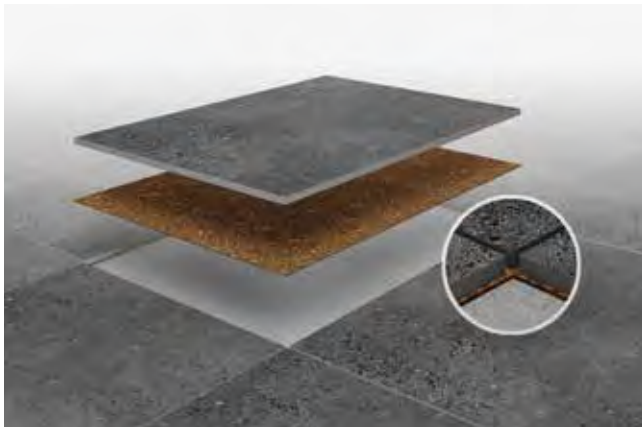
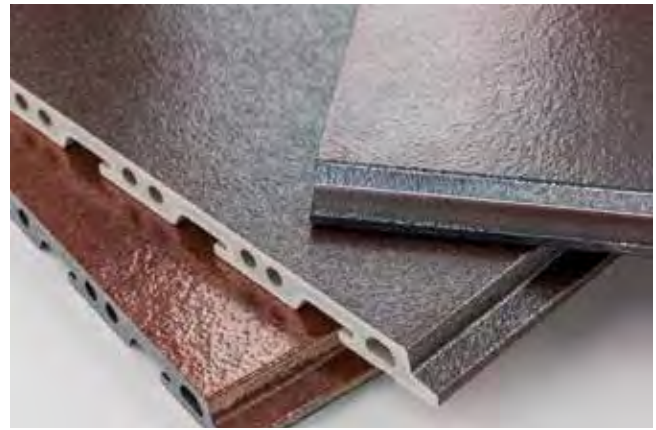

Innovative

We know how to produce great tiles. Yet we work ceaselessly to make them even better. Craftsmanship and new technologies are combined to create innovative slip-resistant surfaces for wet areas and to develop new and simple methods for working with ceramics, such as e.g. DryLile, which allows laying without adhesive. We invest in health and hygiene, as demonstrated by our sustainable Hytect technology, which is used in almost every product we make. In addition to developing innovations in all areas, we are proud of offering tailor-made new solutions and helping architects to realize their best ideas.

Sustainable

The requirements to be met in the construction sector are continuously increasing. Building owners, planners and users make new demands which also include the future developments to a great extent. Energy efficiency, preservation of resources and climate change are the keywords in this context, which have a decisive influence. Agrob Buchtal is aware of its responsibility with regard to sustainable building and supports not only the idea of sustainable building by its membership in the German association for sustainable building (Deutsche Gesellschaft für Nachhaltiges Bauen (DGNB)). Our industry has decided early – in the scope of an ecological product declaration according to ISO 14025 – to make all ecological product data important for the planning process of a sustainable building transparent. The fact whether a building is convincing from the point of view of sustainability can be determined by certification systems. For this, specific product information must be available and documented.



We are on site.
Seven locations and available world-wide.

DSA Deutsche Steinzeug America, Inc



You will find your sales contacts on the pages 720-721.
Or please send us a contact inquiry via the website <http://www.agrob-buchtal.de>.



Alfter-Witterschlick

Ötzingen

Sinzig

Schwarzenfeld

Deutsche Steinzeug Schweiz AG

Deutsche Steinzeug France S.A.R.L

Modular color systems

Modular color systems are designed for complex requirements in all areas of architectural ceramics. The Area Pro series is a real all-rounder with its extensive product range of tiles and accessories. It combines sophisticated design with high functionality and thus offers well thought-out solutions for the most diverse areas of application. As a perfect synthesis of function and aesthetics, Emotion supports consistent room concepts for functional and representative areas. With 50 colors matched to one another and 24 formats, ChromaPlural promotes the varied, room-spanning design of wall and floor surfaces. Fresh and Loop offer particularly exciting colors and formats in the mosaic sector.



Area Pro: naturally intuitive

Good design always conveys an intuitive approach to its use – and thus, designing with Area Pro is also easy. With its earthy shades and pleasant haptics, the wide range of products immediately inspires ideas for their use. The series inspired by fine-grained, layered limestone blends in effortlessly and stands out at the same time. This makes the tiles and their accessories perfect all-rounders in almost every ambience. The new series already exudes the potential to become a classic.

Chroma: the color concept: mixing and combining

When it comes to color design in the pool area, blue is usually the color of choice. However, Chroma also offers warm and neutral shades from the color system inspired by nature – for classics rich in variation, individual accents and a holistic look. A total of 35 different colors are part of the standard delivery programme of the Pool series.

The color scales are divided into six groups: warm, earthy, cool, fresh and sunny shades move around a group of muted, neutral grey shades. Each group contains colors which can be easily combined, both within the group and with other groups. In this way, a consistent and uniform design can always be created.



Plural: colorful and flexible

The color range specially developed for Plural comprises 50 colors matched to one another. Whether glazed or unglazed, earthenware, stoneware or porcelain stoneware – the narrow 3 mm joint is just as standard with Plural as the pollutant-reducing Hytect coating and the design in various slip-resistance classes. Thus, Plural can be used in many indoor and outdoor areas: from the facade to the floor, from the underground station to the wellness landscape.





Emotion: modular and timeless

With colors and surfaces matched to one another, slip-resistant tiles from R9 to R12V4 and a variety of formats from large formats to functional Hytect-coated mosaics (in R10/B), the tiles of the Emotion series offer architects a great deal of freedom. Emotion ensures good design above all where there are transitions between areas with different slip-resistance requirements. Front cooking in visual contact with the restaurant guests is thus just as possible as the smooth and aesthetically successful coexistence of workshop and showroom in a car dealership.

Fresh: fresh and modern

Fresh offers a harmonious range of modern, fresh colors in the popular mosaic formats of 2.5 x 2.5 cm and 5 x 5 cm, with which individual, but at the same time designs, which are uncomplicated to realize, are possible. A particularly practical advantage is that R10/B slip-resistant mosaics in colors matching the tiles are available.

Color gradients accentuate selected areas, liven up overall pictures and stage artistic interplays with homogeneous tiled surfaces. As cladding for individual elements such as columns, partition walls or bar counters, they bring their own rhythm to the room.



Loop: fine and round

The secret of the depth, luminosity and durability of the colors is the glaze. Up to ten layers are applied to the stoneware and fired in to make them abrasion-proof. We create the glazes ourselves – with selected raw materials. This is how mosaics of radiant, lasting beauty are created.

Loop offers a wide spectrum of intensive and muted color shades in the blue and green range, strong yellow, orange and red variants, grey and brown nuances to deep black. Delicate transparency for lightness and timelessness, luminous richness for accent and expression.

Innovative. Hytect – Die Luft ist rein

The Hytect technology is safely baked into the surface of the ceramics at high temperatures. When light falls on the tiles coated in this way, active oxygen is released by photocatalysis. This creates the effect against bacteria and mould. At the same time, Hytect tiles naturally neutralize air pollutants. And because they are also

hydrophilic, dirt and grease hardly stick to them. All these effects work undiminished over the entire service life of the tiles. And thanks to a wide range of products, Hytect ceramics can be used in a wide variety of areas. Our products provided with our Hytect technology are marked with the Hytect logo.

The effects

Extremely easy to clean

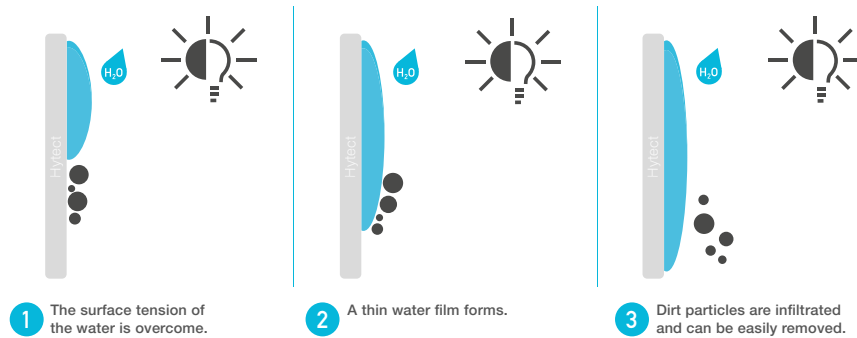

Effective against fungi and bacteria

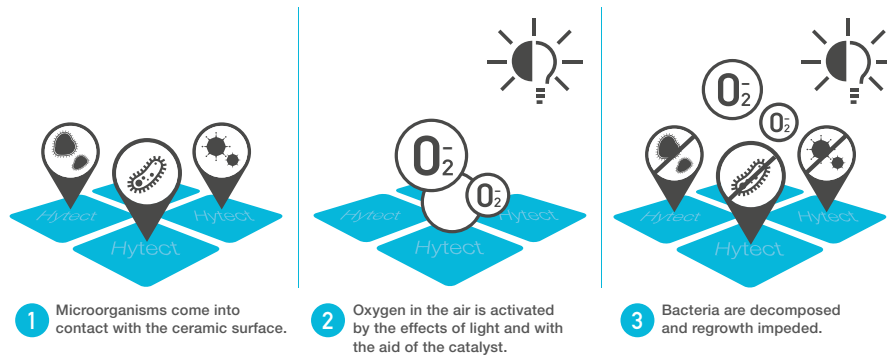

Active elimination of air pollutants

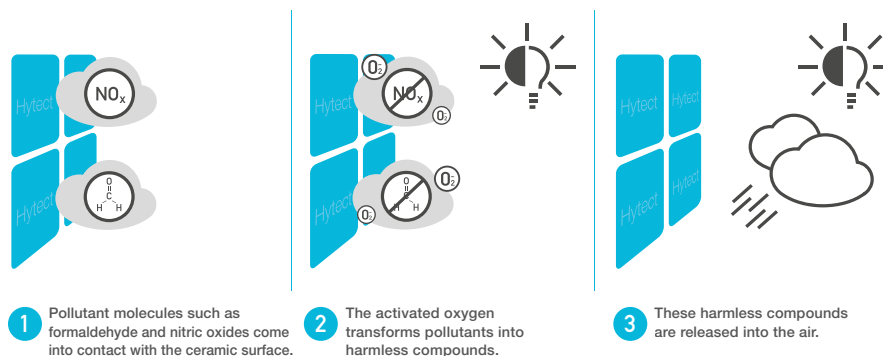

To the Hytect film:



Further information:
www.hytect.com



Slip-resistant tiles for all areas of application

Falls caused by slipping, stumbling/twisting or misstepping are the primary cause of accidents in most companies and facilities. Slip-resistant tiles, marked with the GRIP quality seal, are one of our core competences. Since the market launch of the first slip-resistant tiles in the 1930s, we have continuously further developed this innovation through intensive research.

The results include renowned prizes for exemplary surface designs, functional improvements such as low-noise and vibration-free driving on ceramic coverings as well as micro-rough special glazes for the barefoot areas in swimming pools. The quality of our slip-resistant tiles is guaranteed by permanent controls of the in-house laboratories and neutrally supervised at regular intervals by external institutes as well as the participation in interlaboratory tests with accredited test laboratories.

The latest innovation in slip-resistant tiles: R12V4

In collaboration with the German designer Sebastian Herkner, a special anti-slip surface was developed for Area Pro. Sebastian Herkner was looking for a pattern which looks spontaneous and yet has a certain logic. This is how he came up with the repeating, trapezoidal rectangles and the pattern that can be continued in all four directions. Area Pro is available with various slip-resistant surfaces, including Grid, with a slip resistance of R12V4. None of the slip-resistant surfaces impairs the aesthetics of the tiles. They are also available for large-format tiles, which, due to their properties, may also be used in commercial kitchens.



Designer Sebastian Herkner develops the slip-resistant surface "Grid".



Functionality and beauty combined: the R12V4 surface of the Area Pro series.



The design of Grid.

Individual production for special requirements

More than standard solutions

Creative architects and planners need unlimited design scope in order to be able to realize their ideas in an appropriate manner.



Special colors

They are individually selected or newly composed from almost 20,000 glaze recipes in any shade desired. This also applies to Corporate Colors corresponding to the CD of the respective company.



Water-jet cutting technique

It permits the precise cutting of ceramic tiles in free and also curved forms, which can be combined according to the respective design specifications.



Special formats

They are in demand both in the case of aesthetically sophisticated new buildings and at the renovation of historical buildings and are manufactured exactly according to the specifications of the architects.

The in-house planning department

Efficient support for 7 decades

At Agrob Buchtal, high-quality products and competent services are supplied. In this way, planners and architects using our products can benefit from the know-how of our in-house planning department, which has proved itself since 1952, when specifying our products.

A committed team of qualified technicians, engineers, architects, designers and color experts ensures a quick and problem-free realization of individual concepts. And as these experts are not only specialized advisers but also carry out numerous routine tasks, the customers of Agrob Buchtal can completely concentrate on the realization of their creative ideas. The range of services includes laying plans, determinations of quantities, detailed estimates, texts for bidding purposes or project-specific advice regarding application techniques. Upon request, a person to contact will be at your disposal on location.



We develop product solutions for all areas of application



Retail

Retail concepts require high-quality, authentic materials which are robust and can withstand heavy loads, such as, for example, our extra thick tiles. Or special product solutions such as the DryLile floor tile coated with cork, which is laid dry. This saves an enormous amount of time and is thus an economic advantage for the construction of new buildings or renovation.

DryLile – As fast as your business



Extra thick tiles





Hotel + Gastronomy

Hotels are temporary homes. An all-round successful interior design contributes to making guests feel at home. Authentic materials which create atmosphere and highlight the special charm of the place are in demand. Tiles have been a popular and versatile means of design in architecture for centuries. High-quality ceramics is robust, resistant to wear, color-fast, easy to clean and therefore economical.

Surf



Mosaics for wellness areas





Health + Care

In health and care facilities, the well-being of patients is paramount – whether in patient rooms, operating theatres, treatment rooms, large kitchens, laboratories or therapy baths. The standards of hygiene, cleanliness and accessibility are very high. At the same time, operators want sophisticated interior design with a calming and friendly atmosphere. This has a positive effect on the patients' well-being and thus promotes recovery. We also offer special products for special requirements in health care facilities: ceramics with a special glaze absorb disturbing reflections – specially designed for operating theatres and areas where laser technology is used. Special solutions for therapy pools combine functionality with beautiful design.

Therapy areas



Ceramics against germs





Education

Schools, kindergartens and universities are places of education, just like political, artistic or musical institutions. An attractively designed environment increases the willingness to learn and has an inspiring effect. And when people feel comfortable, they like to come back. Color is an important element for giving rooms atmosphere and expression. In combination with material and texture, a positive, activating environment is created in day-care centres or primary schools, for example. The depth of color, brilliance and expressiveness of ceramics are long-lasting. High-quality ceramics also withstands the stresses and strains of constant public traffic for decades.

Modular color systems



Orientation aid for the blind

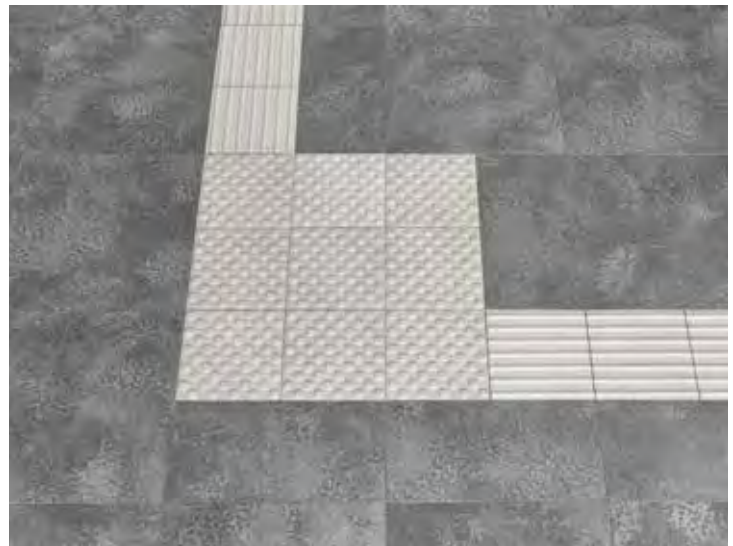



Industry + Infrastructure

The planning and execution of infrastructure buildings are challenging. Buildings such as railway stations, underground stations, tunnels or airports should be multifunctional, look appealing and fit into the cityscape. Thousands of people come together in these areas every day. Highly frequented areas require slip-resistant, robust and low-maintenance building materials, but also easy-to-clean surfaces. This is where the Hytect tile comes in useful. The patented surface coating activates a natural process which cleans the air and neutralizes nitrogen oxides and odours. Likewise, unwanted graffiti is demonstrably easy to remove. Special products such as orientation aids for the blind provide orientation and enable barrier-free design.





Pool + Spa

The conception of contemporary pool architecture is complex and must meet high demands. And not only in terms of design: whether sports, leisure and adventure pools, therapy pools, private and hotel pools, sports and competition pools – they all have to be safe, easy to clean and inexpensive to maintain. Tiles meet these functional requirements: for example, with slip-resistant special surfaces ensuring a safe foothold even when wet. Modularly combinable tiles and special pieces are important for a consistent design from the pool and pool surround to all adjacent areas such as showers, saunas, changing rooms or restaurants.

Consistent design in all pool areas



Color gradients



Laying of pictures



Each individual mosaic tile is placed by hand and then glued on net.



Facade

The facade is more than a protective outer shell. It covers the building like a dress. Its design not only shapes the building itself, but also often has a visible effect on the urban environment. As a building material which has been tried and tested for thousands of years, ceramics also has ideal properties for the facade. It is non-combustible, resistant to chemicals, light-fast, pressure-, impact- and scratch-resistant. In addition, it is harmless in terms of building biology. It scores with its unlimited service life and can be completely recycled. The design possibilities arise from the combination of color, surface, format and shape in all conceivable versions: powerful, rich colors or monochrome, restrained ones. Glazed, unglazed, matt or glossy surfaces. Large-size panels, narrow oblong formats or mosaics for organic shapes. Three-dimensional shapes, baguettes or tubes.

KerAion



KeraShape



KeraTwin



KeraJoin



KeraYou





Living

Wall and floor coverings significantly characterize the overall impression of rooms. When planning contemporary bathrooms and living spaces, design usually is the top priority when it comes to choosing wall and floor coverings. At the same time, the materials used to furnish the home office or dining room, hallway, living room or bathroom should also be hard-wearing and durable. It is important to create living comfort without compromises, ecologically sustainable, easy to clean and barrier-free. We offer products which meet these requirements and create smart additional benefits with the advantages of the antibacterial Hytect surface. From the mosaic up to large formats.

Bathrooms





Kitchen

Living room



Terraces

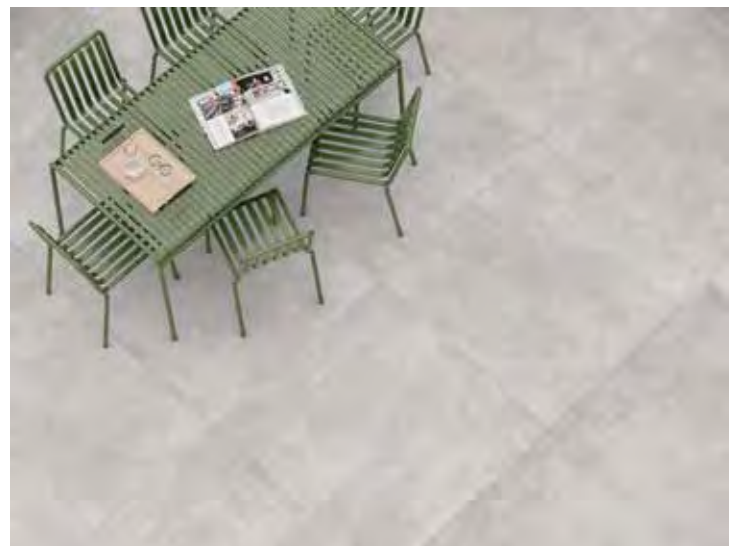

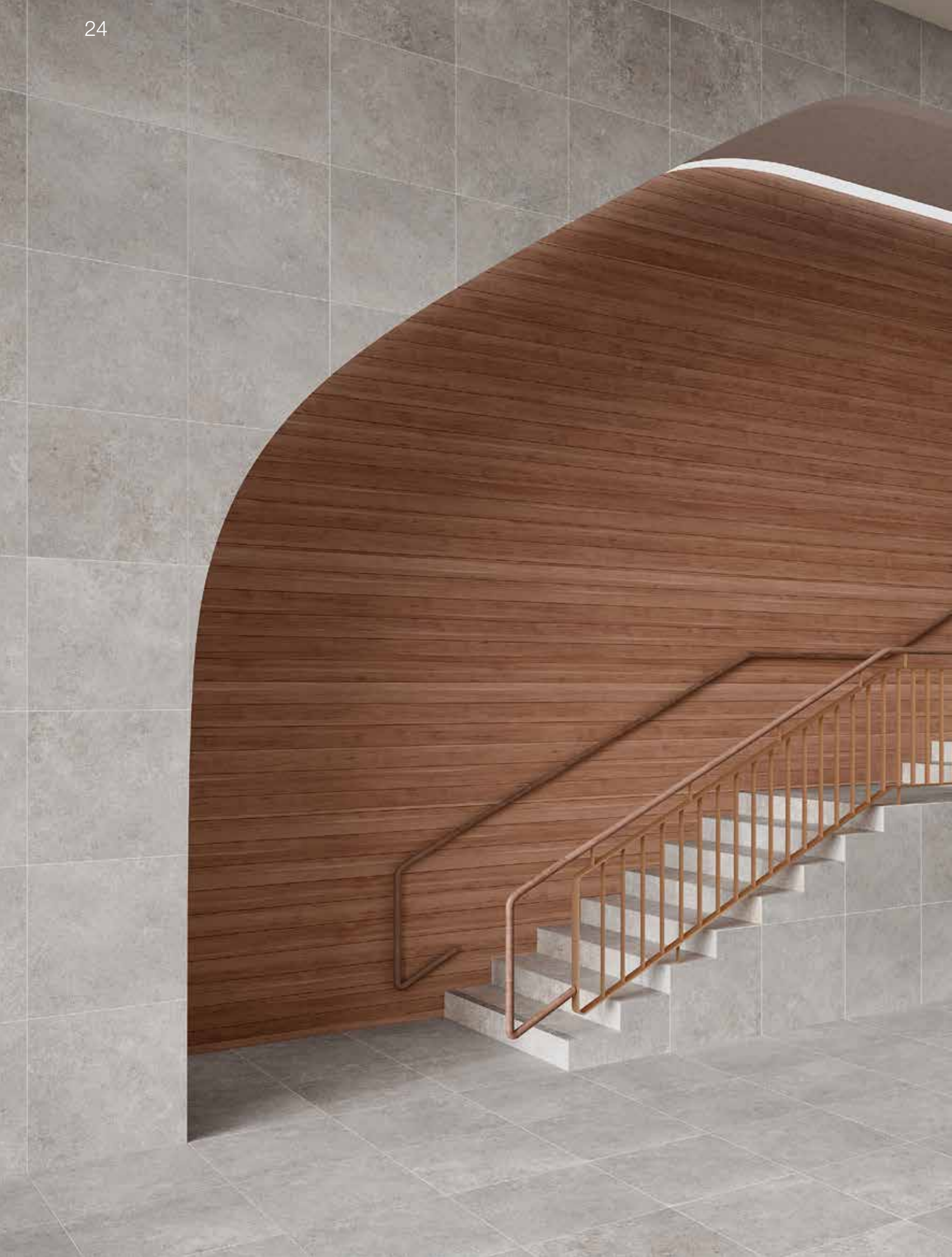



Product Finder

Project

Series	From page	Product category										Color																
		Floor tiles	Floor tiles extra thick	Decoration	Shower floors	Mosaic	Swimming pool	Skirtings	Patio tiles	Stair tiles	Wall tiles	Washbasins	Products suitable for facades ¹	White	Light-grey	Mid-grey	Dark-grey	Black	Light-blue	Medium-blue	Dark-blue	Beige	Brown	Yellow	Orange	Red	Green	Multicolored
Amano	40				•								•	•	•		•	•	•	•	•							•
Area Pro	44	•	•	•	•	•	•	•	•	•	•		•	•	•	•	•			•	•							
Ascona	72	•			•	•	•	•	•	•			•	•	•					•								
Basic Stone	86				•								•	•		•				•	•							
Basis 1	93		•							•			•	•						•							•	
Basis 1+	95									•			•							•								
Basis 2	96	•			•		•						•		•					•								
Basis 3	97	•		•	•		•		•					•	•					•								
Basis 4	99	•											•	•			•		•	•								
Basis Pro	100	•	•		•		•		•				•	•						•	•							
Orientation Aids for the Blind	108	•													•					•								
Chroma	114	•										•	•	•	•	•	•	•	•	•	•	•	•	•	•	•	•	•
Chroma non-slip	124	•										•	•	•	•	•	•	•	•	•	•	•	•	•	•	•	•	•
Chroma unglazed	134	•		•		•	•					•	•	•	•	•	•			•	•							
Craft	142									•			•	•	•	•	•			•	•	•	•	•	•	•	•	•
Craft Extended	150									•			•	•		•	•			•	•				•	•		
District	154				•					•			•	•		•		•		•					•	•		
Eladuct + KerAion Ela 10.6	158	•					•							•						•								
Emotion	162	•	•				•		•	•				•	•					•	•							
Emotion Grip	172	•			•		•		•					•	•	•				•		•						
Ferrum	178	•					•						•	•						•	•							
Fresh	182				•								•	•	•	•	•	•	•	•	•	•	•	•	•	•	•	•
Karl	196				•					•			•	•		•				•	•	•				•		
KerAion Special Glazes for Operating Theatres	202	•											•	•	•		•			•						•		
Loop	206				•							•	•	•	•	•	•	•	•	•	•	•	•	•	•	•	•	•
Marble & More	216				•								•		•		•		•	•						•		
Natural Ceramics	220	•					•		•				•		•					•	•							
New Market	228	•											•	•	•					•	•							
Nova	234	•			•		•		•					•	•					•	•							
Plural	244	•			•		•		•				•	•	•	•	•	•	•	•	•	•	•	•	•	•	•	•
Plural non-slip	264	•		•	•		•						•	•	•	•	•	•	•	•	•	•	•	•	•	•	•	•
Plural unglazed	272	•		•	•		•						•	•	•		•		•	•	•	•	•	•		•		
Plural Kids	278									•																	•	
Quarzit	284	•			•	•	•	•	•	•			•	•						•	•							
Savona	292	•			•		•							•	•					•	•							
Streetlife	298	•					•		•											•								
Surf	304			•						•																		
Trias	312	•			•		•		•				•	•						•	•							
Unique	318	•	•		•		•		•	•			•	•	•					•	•							•
Valley	324	•			•	•	•	•	•	•				•	•					•	•							

Look		Slip resistance																									
Mono-colored	Multicolored	Concrete	Wood	Industrial	Marble	Stone	Hytect	Protecta	R9	R10	R10/A	R10/A+B	R10/B	R11	R11/A	R11/B	R11/C	R11V4	R12	R12/C	R12V4	R12V8	R13	R13V10	-/B	-/C	
•						•	•			•	•	•	•	•	•	•				•	•						
						•	•	•																			
						•	•				•																
•			•																								
•						•																					
•						•	•			•	•																
						•	•			•	•																
•							•																				
•						•																					
•						•	•			•	•																
•						•								•													
•						•	•			•	•																
•						•																					
•						•	•			•	•																
•	•					•	•																				
•	•					•	•																				
•						•	•																				
•						•	•			•	•																
•						•	•																				
•	•					•	•																				
•						•	•																				
•						•	•			•	•																
•						•	•																				
•						•	•			•	•																
•						•	•			•	•																
•						•	•																				
•						•	•																				
•						•	•																				
•						•	•			•	•																
•						•	•																				
•						•	•																				
•						•	•			•	•																
•						•	•																				
•						•	•																				

¹The usability corresponds to DIN 18515-1 or acc. to the certificate of usability of the system provider.

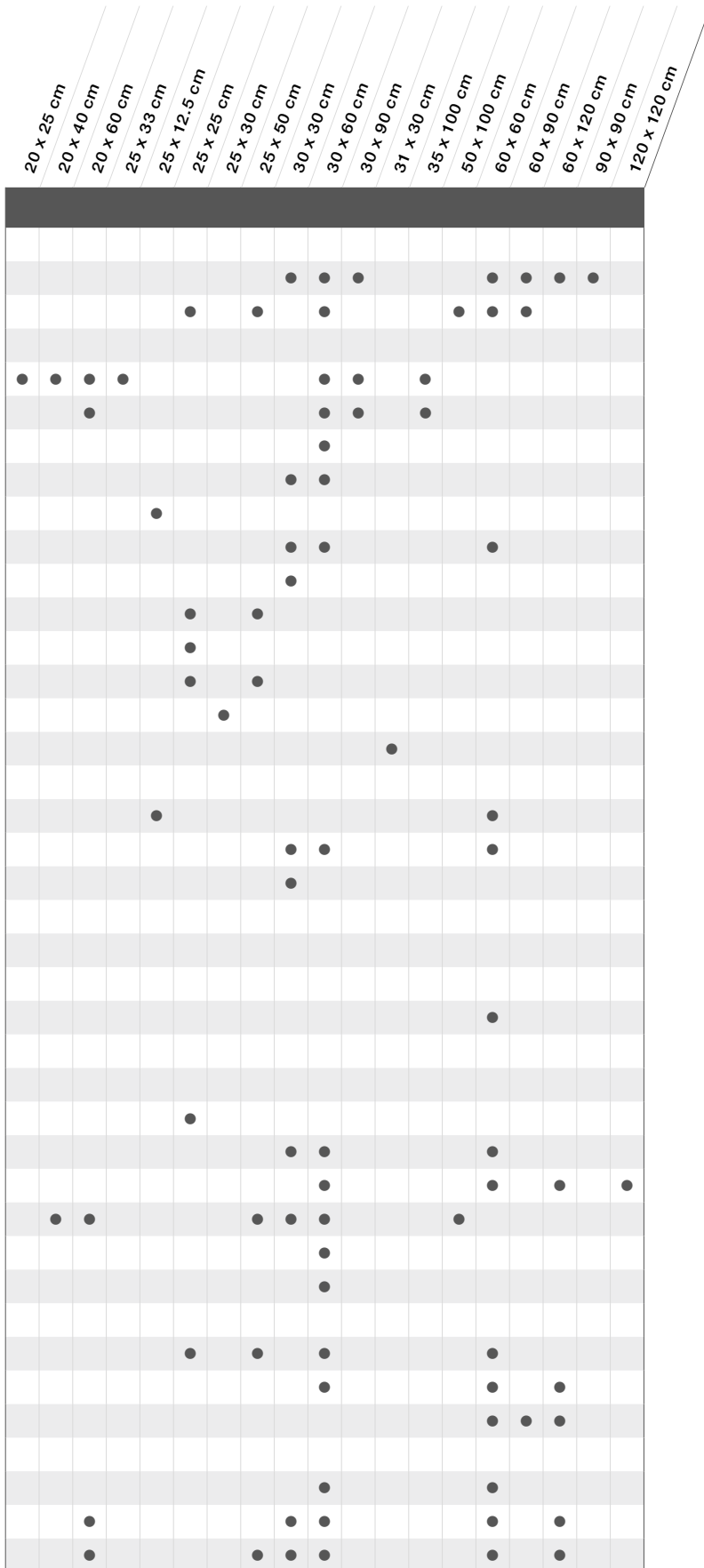

Pool + Spa

Series	From page	Product category														Area of application						
		Floor tiles	Floor tiles extra thick	Decoration	Shower floors	Mosaic	Skirtings	Patio tiles	Stair tiles	Wall tiles	Washbasins	Gutter tiles/covered gutter tiles	Ceramic cover grating	Grid profile tiles	Grooved tiles	Letter tiles	Overflow channels	Other swimming pool special pieces	Pool	Pool surrounds	Showers + changing rooms	Wellness + Spa
Outlets + cover gratings	448																●	●				
Amano*	40				●													●	●	●	●	
Area Pro	44	●	●	●	●	●	●	●	●	●	●	●	●	●					●	●	●	●
Ascona*	72	●			●	●	●	●	●	●	●	●	●	●				●	●	●	●	●
Basic Stone*	86				●													●	●	●	●	
PES Bamberg	400																●	●	●			
PES Berlin**	408																	●				
PES Finland	371																●	●				
PES Finland II	374							●					●				●	●				
PES Skimmer **	416																	●				
PES St. Moritz**	404																	●				
PES Wiesbaden - Elevated water level	380																●	●				
PES Wiesbaden - Decreased water level	392																●	●				
PES Wiesbaden Silent	384																	●				
PES Wiesbaden Stil	388																●	●				
PES Wiesbaden – Therapy pools**	396																	●				
PES Zürich**	412																	●				
Pool edging tiles	420																●	●				
Chroma	338	●																●	●	●	●	
Chroma non-slip	348	●																●	●	●	●	
Chroma unglazed	356	●		●	●							●					●	●	●	●	●	
Emotion*	162	●	●	●		●		●	●			●							●	●	●	●
Fresh*	182				●													●	●	●	●	
Skirtings Profiled edgings	424					●											●	●	●	●		
Ceramic channel cover 2.0	450											●						●	●			
Loop*	206				●													●	●	●	●	
Marble & More*	216				●													●	●	●	●	
Nova*	234	●			●	●		●											●	●		
Plural*	244	●		●	●	●												●	●	●	●	
Plural non-slip*	264	●		●	●	●													●	●	●	●
Plural unglazed*	272	●		●	●	●													●	●	●	●
Quarzit*	284	●			●	●	●	●		●	●	●	●	●	●				●	●	●	●
Grooved tiles	432													●				●	●			
Savona*	292	●			●	●													●	●	●	●
Special tiles	438									●				●		●	●	●	●			
Valley*	324	●			●	●	●	●			●								●	●	●	●

* See chapter Project

** This pool edge system is composed of components from several series. You will find details to this on the relevant information pages about the system.

Pool + Spa

Series	From page	Format																							
		Joint width: 3 mm	Joint width: 6 mm	1 x 1 cm	Ø1 cm	2.5 x 2.5 cm	Ø2 cm	5 x 5 cm	5 x 60 cm	6.2 x 25 cm	10 x 10 cm	10 x 20 cm	10 x 30 cm	10 x 40 cm	10 x 60 cm	12.5 x 12.5 cm	12.5 x 25 cm	12.5 x 50 cm	12.5 x 100 cm	15 x 15 cm	15 x 30 cm	15 x 60 cm	20 x 20 cm	20 x 40 cm	
Outlets + cover gratings	448																								
Amano*	40	●			●																				
Area Pro	44	●					●		●				●						●		●		●		
Ascona*	72	●	●					●						●	●				●						
Basic Stone*	86						●																		
PES Bamberg	400	●																							
PES Berlin**	408																								
PES Finland	371	●																							
PES Finland II	374	●													●										
PES Skimmer **	416																								
PES St. Moritz**	404																								
PES Wiesbaden - Elevated water level	380	●																							
PES Wiesbaden - Decreased water level	392	●																							
PES Wiesbaden Silent	384																								
PES Wiesbaden Stil	388	●																							
PES Wiesbaden – Therapy pools**	396																								
PES Zürich**	412																								
Pool edging tiles	420	●																							
Chroma	338	●							●						●	●	●								
Chroma non-slip	348	●													●	●									
Chroma unglazed	356	●													●	●									
Emotion*	162	●												●										●	
Fresh*	182	●			●		●																		
Skirtings Profiled edgings	424	●																							
Ceramic channel cover 2.0	450																								
Loop*	206	●		●		●																			
Marble & More*	216	●	●		●																				
Nova*	234	●					●						●						●		●				
Plural*	244	●	●		●		●			●	●	●	●	●			●	●	●	●		●	●	●	●
Plural non-slip*	264	●			●		●			●														●	
Plural unglazed*	272	●			●		●			●									●				●		
Quarzit*	284	●	●				●							●	●				●						
Grooved tiles	432	●												●											
Savona*	292	●					●												●						
Special tiles	438	●												●	●										
Valley*	324	●	●					●	●					●					●		●				

* See chapter Project

** This pool edge system is composed of components from several series. You will find details to this on the relevant information pages about the system.

Living

Series	From page	Product category										Color										Look									
		Floor tiles	Decoration	Mosaic	Skirting	Patio tiles	Stair tiles	Wall tiles	White	Light-grey	Mid-grey	Dark-grey	Black	Light-blue	Beige	Brown	Red	Green	Multicolored	Metallic	Mono-colored	Multicolored	Concrete	Wood	Industrial	Marble	Stone	Vintage			
Alcina	460	•	•	•	•	•	•	•	•	•	•	•	•	•	•												•				
Aruba	472	•	•	•	•	•	•	•	•	•	•	•	•	•	•												•				
Basis 1	480	•					•	•	•				•				•		•						•						
Bliss	488	•					•	•								•			•						•						
Cedra	492	•	•	•	•		•		•	•			•	•												•					
Como	500	•					•	•			•		•								•					•					
Concrete	504	•	•				•	•		•			•									•				•					
Evalia	510	•	•	•	•		•	•	•	•			•												•	•					
Focus Royal	518	•	•				•	•		•			•	•	•				•							•					
Jasba-CLARA	524		•				•	•	•			•			•	•										•					
Jasba-NIVELLA	550																														
Jasba-PATTERN	528	•	•				•	•	•	•	•		•				•		•							•					
Jasba-RONDA	536		•						•					•										•							
Jasba-SENJA PURE	540		•				•	•	•				•	•								•									
Jasba-VILLAGE	546		•						•	•			•	•												•					
Kiano	554	•	•	•	•	•	•	•	•	•			•	•				•			•										
La Casa	562		•	•			•	•	•	•			•	•				•	•							•					
Like	568	•	•	•	•	•	•	•	•	•												•				•					
Lounge	578	•	•	•	•		•	•	•	•			•												•	•	•				
Lunar	586	•					•	•	•	•			•	•												•					
Mandalay	590		•				•	•	•																	•					
Mando	594		•				•	•	•				•	•								•									
Modern White	600		•				•	•	•	•						•			•	•				•							
Oak	606	•	•	•	•	•				•				•									•								
Pizarro	612		•				•	•	•	•																•					
Sento	616	•	•	•	•		•	•	•		•	•	•	•								•				•					
Sierra	626	•		•	•	•		•	•				•													•					
Sky	632		•				•	•	•	•			•	•									•		•						
Solid Rock	636	•	•	•	•	•		•	•	•																•					
Soul	646	•		•	•	•			•	•				•								•									
Stories	652	•	•	•	•	•	•	•	•	•			•									•									
Timeless	662	•	•	•	•		•	•	•				•						•							•					
Urban Cotto	668	•		•					•				•	•												•					
Walden	672	•		•	•		•						•	•								•									

Living

Series	From page	Format																													
		2.5 x 2.5 cm	5 x 5 cm	5 x 60 cm	10 x 10 cm	10 x 60 cm	15 x 15 cm	15 x 60 cm	15 x 90 cm	20 x 120 cm	20 x 20 cm	20 x 25 cm	20 x 40 cm	20 x 60 cm	22.5 x 90 cm	25 x 33 cm	25 x 44 cm	30 x 120 cm	30 x 30 cm	30 x 45 cm	30 x 60 cm	30 x 90 cm	35 x 100 cm	40 x 120 cm	45 x 90 cm	60 x 60 cm	60 x 120 cm	80 x 80 cm	90 x 90 cm	100 x 100 cm	120 x 120 cm
Alcina	460	•																		•	•			•	•				•		
Aruba	472																			•	•				•	•					
Basis 1	480					•				•	•	•	•		•					•	•	•									
Bliss	488																						•								
Cedra	492	•			•	•														•	•				•	•					
Como	500																			•											
Concrete	504																			•											
Evalia	510	•																		•	•				•	•					
Focus Royal	518																	•		•	•										
Jasba-CLARA	524				•		•																								
Jasba-NIVELLA	550																														
Jasba-PATTERN	528	•	•		•						•																				
Jasba-RONDA	536	•	•																												
Jasba-SENJA PURE	540	•	•									•								•	•										
Jasba-VILLAGE	546	•																													
Kiano	554	•																•		•	•				•						
La Casa	562																			•	•										
Like	568	•																			•				•		•				•
Lounge	578	•																			•	•				•	•				•
Lunar	586																				•	•									
Mandalay	590																				•										
Mando	594																						•								
Modern White	600					•															•	•									
Oak	606																	•			•	•			•			•			
Pizarro	612																				•										
Sento	616	•																			•				•	•					
Sierra	626	•																		•											
Sky	632																						•								
Solid Rock	636	•	•		•		•														•				•	•					
Soul	646	•																			•					•					
Stories	652	•																			•	•		•						•	
Timeless	662																				•	•			•	•					
Urban Cotto	668																								•						
Walden	672																							•							







Project



Studio photo / Architect: Anne Doris Fluck / Series: Amano / Photo: Jochen Stüber





Deeply impressive and lively

Inspired by the motion of water, Amano is characterized by a finely textured relief surface. In combination with blurred glazes, Amano creates watercolor-like effects and lends the series natural charm and exclusive liveliness. Amano distinguishes itself by delicately transparent, muted colors and smooth contrasts. When the light is refracted on the glossy surface, Amano impresses with sparkling reflections.

Mosaic 2.5 x 2.5 cm, 1 x 1 in



Mosaic sheet 30 x 30 cm
cream, relief

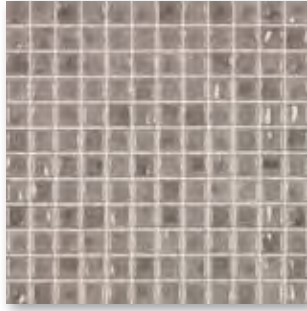

Mosaic sheet 30 x 30 cm
taupe, relief



Mosaic sheet 30 x 30 cm,
light grey, relief

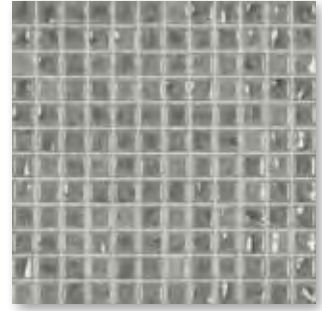

Mosaic sheet 30 x 30 cm
medium grey, relief

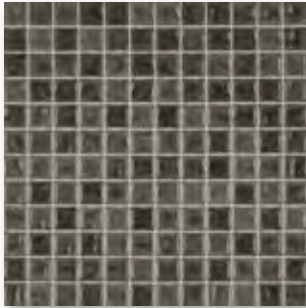

Mosaic sheet 30 x 30 cm
anthracite, relief



Mosaic sheet 30 x 30 cm
ice blue, relief



Mosaic sheet 30 x 30 cm
silk blue, relief



Mosaic sheet 30 x 30 cm
pure blue, relief



Mosaic sheet 30 x 30 cm
metallic, relief



Mosaic sheet 30 x 30 cm
medium grey-metallic-mix, relief



Mosaic sheet 30 x 30 cm
taupe-metallic-mix, relief

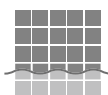

Mosaics glued thermoplastically on back of AGROB BUCHTAL can be used not only in dry zones but also without any problems in underwater areas (e.g. swimming pools/whirlpools) as well as in permanently wet areas (e.g. pool surrounds/showers).

Mosaic

2.5 x 2.5 cm

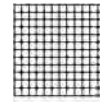

Mosaic, glued
thermoplastically
on back
Sheet: 297 x 297 mm



						2.5 x 2.5 / 1 x 1		Nom. dim. - cm/in
						23 x 23 x 6.5 mm		Work size
						glossy, relief		Surface
						11 sheets		m ² - pieces
						12.100		m ² - kg
						11 sheets		Bundle - pieces
						1.000		Bundle - m ²
						12.100		Bundle - kg
						48.000		Pallet - m ²
						580.800		Pallet - kg
						BIb		Product standard
						1 - 2		Stress group
						41920H ¹	3	
						Price gr. A250 (m ²)		cream
						41921H ¹	3	
						Price gr. A250 (m ²)		taupe
						41922H ¹	3	
						Price gr. A250 (m ²)		light-grey
						41923H ¹	3	
						Price gr. A250 (m ²)		medium grey
						41924H ¹	2	
						Price gr. A250 (m ²)		anthracite
						41925H ¹	3	
						Price gr. A250 (m ²)		ice blue
						41926H ¹	3	
						Price gr. A250 (m ²)		silk blue
						41927H ¹	2	
						Price gr. A250 (m ²)		pure blue
						41928H ^{2/3}	2	
						Price gr. A475 (pce.)		metallic
						41929H ^{2/3}	2	
						Price gr. A458 (pce.)		medium
						41930H ^{2/3}	2	
						Price gr. A458 (pce.)		grey-metallic-mix
						41930H ^{2/3}	2	
						Price gr. A458 (pce.)		taupe-metallic-mix

¹ Color Shade Variation: V1

² Color Shade Variation: V2

³ Not or only to a limited extent resistant to acids and alkalis.

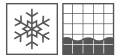

3D-Rendering / Series: Area Pro

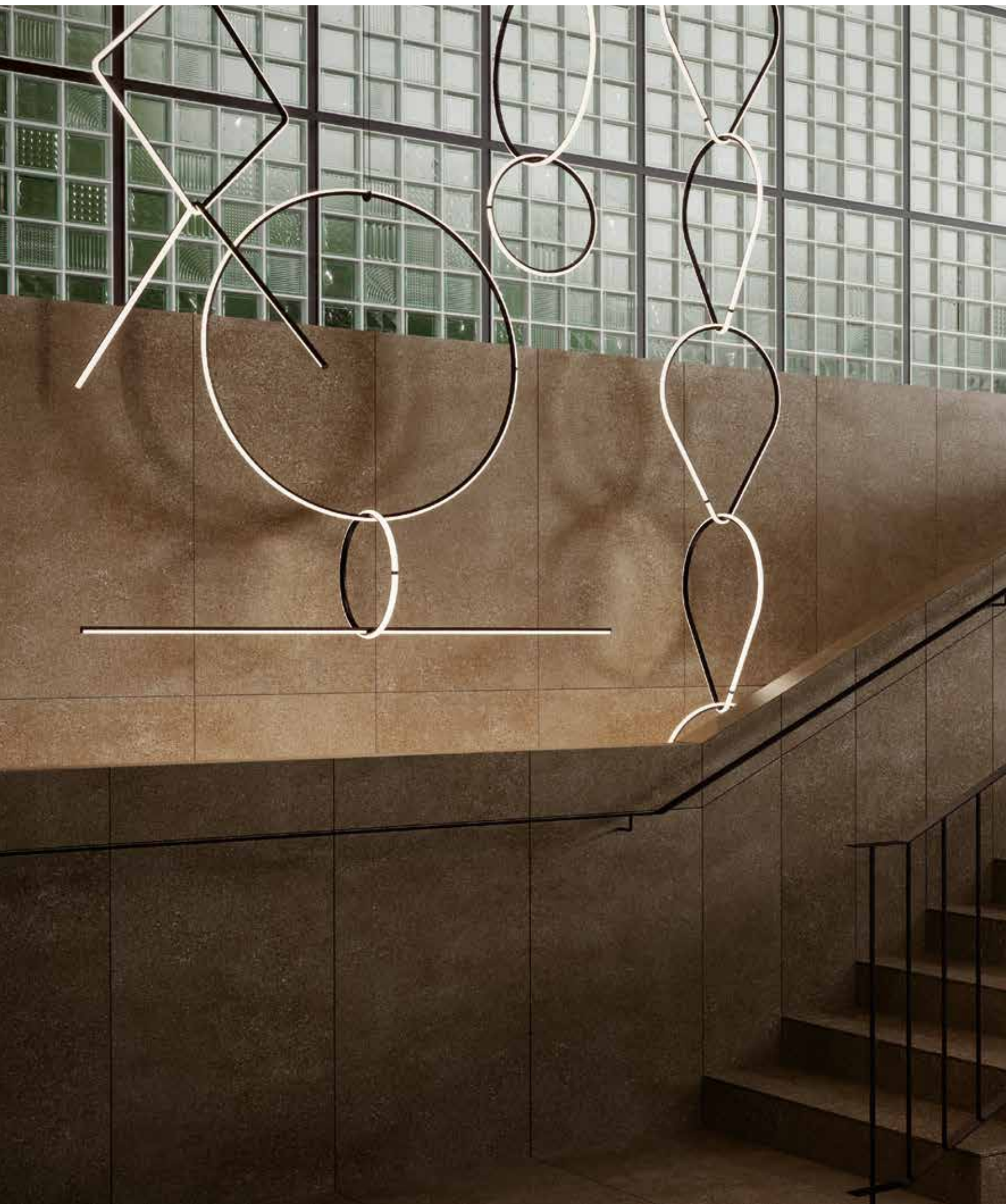



Area Pro comes naturally

Just as the best design objects offer an intuitive understanding of how to use them, the Area Pro series also comes naturally. With its earthy colors and pleasant tactility, the wide range of ceramic products offered by Area Pro immediately spurs ideas on how to use them. The Area Pro series, which is inspired by fine-grained, layered limestone, blends in and stands out. This



makes these tiles and accessories reliable perfect all-rounders in almost every ambience. The new series already exudes the potential to become a classic. Area Pro is the ceramic equivalent to the little black dress or a classic white shirt. Whether in office buildings, residential buildings or leisure facilities — like the fashion classics, the series is convincing in any environment and is thus a true all-rounder. All tiles can be laid regardless of direction. In addition, they impress with their versatility and a variety of formats and color shades. All colors of Area Pro are matched to the ChromaPlural series of AGROB BUCHTAL, so that they can be combined with each other in many ways. In addition, customized projects are also possible with this series.





Grid

In order to live up to its own claim of combining high functionality with sophisticated design, AGROB BUCHTAL engaged design shooting star Sebastian Herkner, who normally works for brands such as Thonet, Ligne Roset or Moroso. He created a completely new design for the surface of the highest slip-resistance class. The result: "the Grid".



Smart features

Always perfect grip



Area Pro is available with diverse slip-resistant surfaces, including Grid with a slip resistance of R12V4.

Sustainable, thin wall tiles



In the case of the 6 mm thin wall tiles, less material is required. Less material means less energy at production and transport as well as a lower weight.

Innovation DryLile



The DryLile system is available for floor tiles between 30 x 60 cm and 60 x 120 cm. DryLile is an innovative technology at which a cork compound is applied on the back of the tiles. Thanks to this cork layer, the tiles can be laid without the use of adhesive.

Hytect hygienic surface



Area Pro tiles are provided with the sustainable Hytect surface, which makes them extremely easy to clean. In addition, Hytect protects ceramic tiles against bacteria and mould and neutralizes air pollutants and unpleasant odours.

Washbasins and shower trays



Area Pro also includes a selection of ceramic washbasins and ceramic shower floors, which are available in all twelve colors of the series.

Ceramic channel cover



For tiles laid around the pool in swimming baths, Agrob Buchtal offers the appropriate termination which ensures visual continuity: a channel cover with water-cut openings.



R10/A R10/B R11/B R11/C R12/C R12V4



Surfaces: Floor tiles



smooth

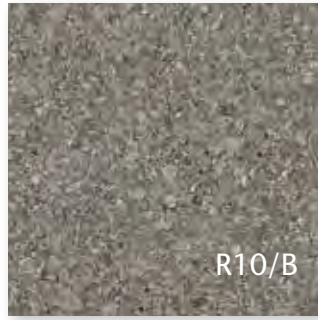

smooth

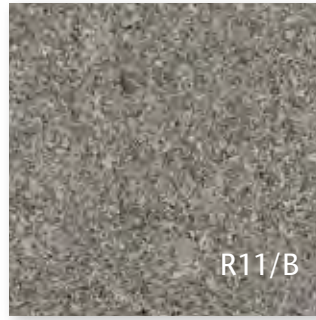

smooth



smooth



Floor tile 15 x 15 cm, 6 x 6 in, smooth, R10/B
Floor tile 15 x 15 cm, 6 x 6 in, smooth, R11/C



Floor tile 20 x 20 cm, 8 x 8 in, smooth, R10/A
Floor tile 20 x 20 cm, 8 x 8 in, Softcorn 2, R11/B
Floor tile 20 x 20 cm, 8 x 8 in, Perlstic, R12/C
Floor tile 20 x 20 cm, 8 x 8 in, Grid, R12V4

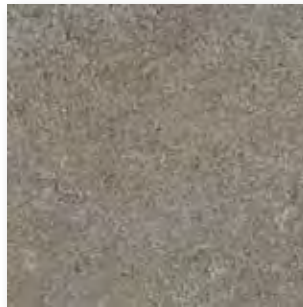

Floor tile 30 x 30 cm, 12 x 12 in, smooth, R10/A
Floor tile 30 x 30 cm, 12 x 12 in, smooth, R11/B



Oblong format 10 x 60 cm, 12 x 24 in, smooth, R10/A



Oblong format 15 x 60 cm, 6 x 24 in, smooth, R10/A

Mosaic 5 x 5 cm, 2 x 2 in



Mosaic sheet 30 x 30 cm, 12 x 12 in, smooth, R10/B

Mosaic 10 x 10 cm, 4 x 4 in



Mosaic sheet 30 x 30 cm, 12 x 12 in, smooth, R10/B
Mosaic sheet 30 x 30 cm, 12 x 12 in, smooth, R11/C

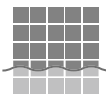

Mosaics glued thermoplastically on back of AGROB BUCHTAL can be used not only in dry zones but also without any problems in underwater areas (e.g. swimming pools/whirlpools) as well as in permanently wet areas (e.g. pool surrounds/showers).

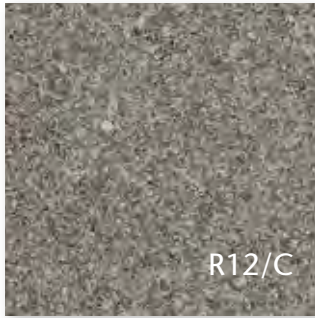

smooth

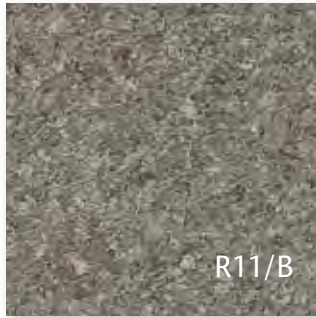

Softcorn 2

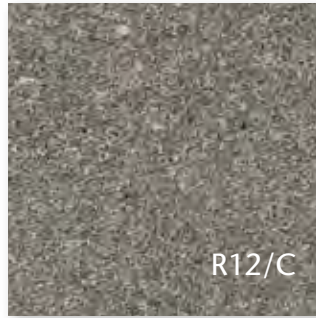

Perlstic



Grid



*Floor tile 60 x 60 cm, 24 x 24 in, smooth, R10/A
 Floor tile 60 x 60 cm, 24 x 24 in, smooth, R11/B
 Floor tile 60 x 60 cm, 24 x 24 in, Grid, R12V4*

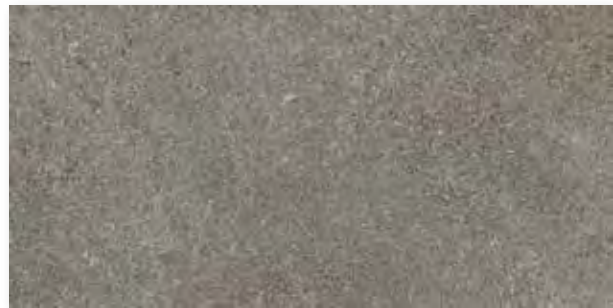

*Floor tile 30 x 60 cm, 12 x 24 in, smooth, R10/A
 Floor tile 30 x 60 cm, 12 x 24 in, smooth, R11/B
 Floor tile 30 x 60 cm, 12 x 24 in, smooth, R12/C*



Floor tile 60 x 90 cm, 24 x 36 in, smooth, R10/A



R10/A R11/B



Floor tile 90 x 90 cm, 36 x 36 in, smooth, R10/A



Floor tile 60 x 120 cm, 24 x 48 in, smooth, R10/A
Floor tile 60 x 120 cm, 24 x 48 in, smooth, R11/B



*Stair tile 30 x 30 cm, 12 x 12 in
(with grooves), smooth, R10/A*



*Stair tile 30 x 60 cm, 12 x 24 in,
(with grooves), smooth, R10/A*



Stair tile with bevel 31 x 135 cm, 12.4 x 54 in, smooth, R10/A



Riser 28 x 135 cm, 11.2 x 54 in, smooth

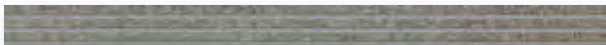

Stair edge 4 x 60 cm, 1.6 x 24 in, smooth, R10/A



R10/A R10/B R11/B



Skirting, rounded 7 x 30 cm, 2.8 x 12 in, smooth



Skirting, rounded 7 x 60 cm, 2.8 x 24 in, smooth



Cove skirting 10 x 10 cm, 4 x 4 in, smooth, R10/A



Cove skirting 10 x 20 cm, 4 x 8 in, smooth, R10/A



Cove skirting 10 x 30 cm, 4 x 12 in, smooth, R10/A



Cove skirting 10 x 60 cm, 4 x 24 in, smooth, R10/A



Internal corner for cove skirting, smooth



External corner for cove skirting, smooth



Shower tub system Strip 10 x 10 cm, smooth, R10/B



Shower tub system Corner 10 x 10 cm, smooth, R10/B



sand



sand-beige



sand-grey



pebble



basalt



anthracite



Patio tile 60 x 60 cm, 24 x 24 in, smooth, R11/B



sand-beige



sand-grey



basalt



Patio tile decor Square, 60 x 60 cm, 24 x 24 in, smooth, R11/B



Wall tile 30 x 60 cm, 12 x 24 in, white, smooth



Wall tile 30 x 60 cm, 12 x 24 in, grey, smooth



Wall tile 30 x 60 cm, 12 x 24 in, beige, smooth

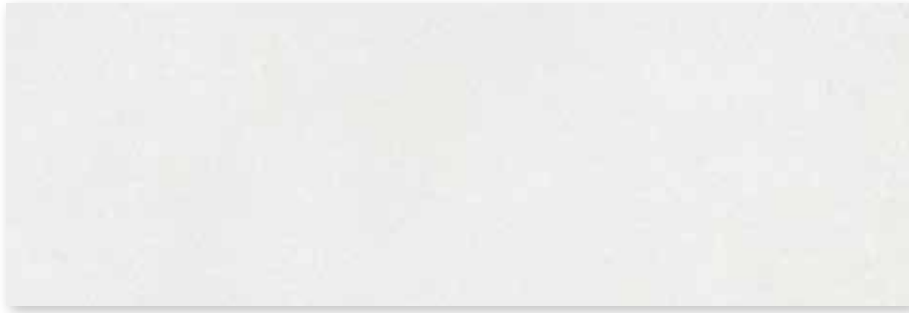

Wall tile 30 x 90 cm, 12 x 36 in, white, smooth



Wall tile 30 x 90 cm, 12 x 36 in, grey, smooth



Wall tile 30 x 90 cm, 12 x 36 in, beige, smooth



brick



clay



nutmeg



sand



sand-beige



sand-white



platinum



sand-grey



stone



pebble



basalt



anthracite

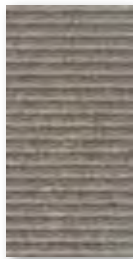

Grooved tile 12.5 x 25 cm,
5 x 10 in, grooved, R11/C



Grooved tile 25 x 25 cm,
10 x 10 in, grooved, R11/C



Grooved tile 50 x 25 cm,
20 x 10 in, grooved, R11/C



Gutter tile ¹, 50 x 25 cm, 20 x 10 in,
smooth, R11/B



Gutter tile, mitred pair,
smooth, R11/B



Gutter tile with outlet,
smooth, R11/B



Terminal piece,
smooth, R11/B



Ceramic channel cover,
corner solution 30 x 30 cm, 12 x 12 in



Ceramic channel cover ²
25 x 50 cm, 10 x 20 in

¹ For details, refer to the chapter Pool + Spa, pages 444 and the following (make-to-order production).

² For details, refer to the chapter Pool + Spa; Ceramic channel cover 2.0, pages 451 and the following (make-to-order production).



Washbasin SURF small 40 x 60 cm**



Washbasin SURF medium 45 x 80 cm**



Washbasin SURF large 55 x 120 cm**

**(available on request) Further information about Surf on the pages 305 and the following.*

Wall Tiles

Mosaics²

30 x 60 cm

30 x 90 cm¹5 x 5 cm **NEW**

10 x 10 cm



10 x 10 cm



Mosaic, glued
thermoplastically
on back
Sheet: 297 x 297 mm

Mosaic, glued
thermoplastically
on back
Sheet: 297 x 297 mm

Mosaic, glued
thermoplastically
on back
Sheet: 297 x 297 mm

Nom. dim. - cm/in	30 x 60 / 12 x 24	30 x 90 / 12 x 36	5 x 5 / 2 x 2	10 x 10 / 4 x 4	10 x 10 / 4 x 4		
Work size	297 x 597 x 6 mm	297 x 897 x 6 mm	47 x 47 x 6.5 mm	97 x 97 x 6.5 mm	97 x 97 x 6.5 mm		
Surface	smooth, stone-matt	smooth, stone-matt	smooth, matt	smooth, matt	smooth, matt		
m ² - pieces	5.556	3.704	11 sheets	11 sheets	11 sheets		
m ² - kg	10.279	10.400	12.331	13.101	13.101		
Bundle - pieces	13	8	11 sheets	11 sheets	11 sheets		
Bundle - m ²	2.339	2.160	1.000	1.000	1.000		
Bundle - kg	24.050	22.464	12.331	13.101	13.101		
Pallet - m ²	112.311	51.836	64.000	64.000	64.000		
Pallet - kg	1,154.444	539.136	789.184	838.464	838.464		
Product standard	BIII	BIII	Bla	Bla	Bla		
Slip resistance			R10/B	R10/B	R11/C		
Stress group			1 - 2	1 - 2	1 - 2		
white	203232H Price gr. A76 (m ²)	323235H Price gr. A166 (m ²)					
grey	203233H Price gr. A76 (m ²)	323236H Price gr. A166 (m ²)					
beige	203234H Price gr. A76 (m ²)	323237H Price gr. A166 (m ²)					
anthracite			430185H Price gr. A196 (m ²)	430220H Price gr. A148 (m ²)	430232H Price gr. A148 (m ²)		
basalt			430186H Price gr. A196 (m ²)	430221H Price gr. A148 (m ²)	430233H Price gr. A148 (m ²)		
pebble			430187H Price gr. A196 (m ²)	430222H Price gr. A148 (m ²)	430234H Price gr. A148 (m ²)		
stone				430223H Price gr. A148 (m ²)	430235H Price gr. A148 (m ²)		
sand-white				430224H Price gr. A148 (m ²)	430236H Price gr. A148 (m ²)		
sand-grey			430188H Price gr. A196 (m ²)	430225H Price gr. A148 (m ²)	430237H Price gr. A148 (m ²)		
sand			430189H Price gr. A196 (m ²)	430226H Price gr. A148 (m ²)	430238H Price gr. A148 (m ²)		
nutmeg				430227H Price gr. A148 (m ²)	430239H Price gr. A148 (m ²)		
platinum				430228H Price gr. A148 (m ²)	430240H Price gr. A148 (m ²)		
sand-beige			430190H Price gr. A196 (m ²)	430229H Price gr. A148 (m ²)	430241H Price gr. A148 (m ²)		
brick				430230H Price gr. A148 (m ²)	430242H Price gr. A148 (m ²)		
clay				430231H Price gr. A148 (m ²)	430243H Price gr. A148 (m ²)		

¹ Edges sanded

All products: Color Shade Variation V2

Floor Tiles

15 x 15 cm



15 x 15 cm



20 x 20 cm



20 x 20 cm



20 x 20 cm



20 x 20 cm



	15 x 15 / 6 x 6	15 x 15 / 6 x 6	20 x 20 / 8 x 8	20 x 20 / 8 x 8	20 x 20 / 8 x 8	20 x 20 / 8 x 8	
	147 x 147 x 10.5 mm	147 x 147 x 10.5 mm	197 x 197 x 10.5 mm	197 x 197 x 10.5 mm	197 x 197 x 10.5 mm	197 x 197 x 10.5 mm	Nom. dim. - cm/in
	smooth, matt	smooth, matt	smooth, matt	structured, matt	fine-grained, matt	profiled, matt	Work size
	44.444	44.444	25.000	25.000	25.000	25.000	Surface
	23.111	23.111	22.900	22.900	22.900	22.900	m ² - pieces
	27	27	21	21	21	21	m ² - kg
	0.607	0.607	0.840	0.840	0.840	0.840	Bundle - pieces
	14.040	14.040	19.236	19.236	19.236	19.236	Bundle - m ²
	48.600	48.600	50.400	50.400	50.400	50.400	Bundle - kg
	1,123.200	1,123.200	1,154.160	1,154.160	1,154.160	1,154.160	Pallet - m ²
	Bla	Bla	Bla	Bla	Bla	Bla	Pallet - kg
	R10/B	R11/C	R10/A	R11/B	R12/C	R12V4	Product standard
	2 - 3	2 - 3	3	3	3	3	Slip resistance
	430244H	430256H	430268H	430274H	430280H	430286H	Stress group
	Price gr. A142 (m ²)	Price gr. A142 (m ²)	Price gr. A133 (m ²)	Price gr. A133 (m ²)	Price gr. A157 (m ²)	Price gr. A157 (m ²)	anthracite
	430245H	430257H	430269H	430275H	430281H	430287H	basalt
	Price gr. A142 (m ²)	Price gr. A142 (m ²)	Price gr. A133 (m ²)	Price gr. A133 (m ²)	Price gr. A157 (m ²)	Price gr. A157 (m ²)	pebble
	430246H	430258H	430270H	430276H	430282H	430288H	sand-grey
	Price gr. A142 (m ²)	Price gr. A142 (m ²)	Price gr. A133 (m ²)	Price gr. A133 (m ²)	Price gr. A157 (m ²)	Price gr. A157 (m ²)	sand
	430249H	430261H	430271H	430277H	430283H	430289H	sand-beige
	Price gr. A142 (m ²)	Price gr. A142 (m ²)	Price gr. A133 (m ²)	Price gr. A133 (m ²)	Price gr. A157 (m ²)	Price gr. A157 (m ²)	
	430250H	430262H	430272H	430278H	430284H	430290H	
	Price gr. A142 (m ²)	Price gr. A142 (m ²)	Price gr. A133 (m ²)	Price gr. A133 (m ²)	Price gr. A157 (m ²)	Price gr. A157 (m ²)	
	430253H	430265H	430273H	430279H	430285H	430291H	
	Price gr. A142 (m ²)	Price gr. A142 (m ²)	Price gr. A133 (m ²)	Price gr. A133 (m ²)	Price gr. A157 (m ²)	Price gr. A157 (m ²)	

All products: Color Shade Variation V2



Floor Tiles

30 x 30 cm



30 x 30 cm



10 x 60 cm^{1/2}



15 x 60 cm^{1/2}



30 x 60 cm^{1/3}



30 x 60 cm¹



30 x 60 cm¹



Oblong format

Oblong format

Nom. dim. - cm/in	30 x 30 / 12 x 12	30 x 30 / 12 x 12	10 x 60 / 4 x 24	15 x 60 / 6 x 24	30 x 60 / 12 x 24	30 x 60 / 12 x 24	30 x 60 / 12 x 24
Work size	297 x 297 x 10.5 mm	297 x 297 x 10.5 mm	97 x 597 x 10.5 mm	147 x 597 x 10.5 mm	297 x 597 x 10.5 mm	297 x 597 x 10.5 mm	297 x 597 x 10.5 mm
Surface	smooth, matt	smooth, matt	smooth, matt	smooth, matt	smooth, matt	smooth, matt	smooth, matt
m ² - pieces	11.111	11.111	16.667	11.111	5.556	5.556	5.556
m ² - kg	23.142	23.142	36.667	23.222	23.224	23.224	23.224
Bundle - pieces	11	11	15	11	6	6	6
Bundle - m ²	0.990	0.990	0.900	0.990	1.080	1.080	1.080
Bundle - kg	22.913	22.913	21.300	22.990	25.080	25.080	25.080
Pallet - m ²	47.525	47.525	36.000	39.600	43.200	43.200	43.200
Pallet - kg	1,099.824	1,099.824	852.012	919.600	1,003.200	1,003.200	1,003.200
Product standard	Bla	Bla	Bla	Bla	Bla	Bla	Bla
Slip resistance	R10/A	R11/B	R10/A	R10/A	R10/A	R11/B	R12/C
Stress group	2 - 3	2 - 3	2 - 3	2 - 3	2 - 3	2 - 3	2 - 3
anthracite	430292H Price gr. A109 (m ²)	430304H Price gr. A109 (m ²)	430316H Price gr. A199 (m ²)	430328H Price gr. A199 (m ²)	430340H Price gr. A121 (m ²)	430352H Price gr. A121 (m ²)	430364H Price gr. A154 (m ²)
basalt	430293H Price gr. A109 (m ²)	430305H Price gr. A109 (m ²)	430317H Price gr. A199 (m ²)	430329H Price gr. A199 (m ²)	430341H Price gr. A121 (m ²)	430353H Price gr. A121 (m ²)	430365H Price gr. A154 (m ²)
pebble	430294H Price gr. A109 (m ²)	430306H Price gr. A109 (m ²)	430318H Price gr. A199 (m ²)	430330H Price gr. A199 (m ²)	430342H Price gr. A121 (m ²)	430354H Price gr. A121 (m ²)	430366H Price gr. A154 (m ²)
stone	430295H Price gr. A109 (m ²)	430307H Price gr. A109 (m ²)	430319H Price gr. A199 (m ²)	430331H Price gr. A199 (m ²)	430343H Price gr. A121 (m ²)	430355H Price gr. A121 (m ²)	430367H Price gr. A154 (m ²)
sand-white	430296H Price gr. A109 (m ²)	430308H Price gr. A109 (m ²)	430320H Price gr. A199 (m ²)	430332H Price gr. A199 (m ²)	430344H Price gr. A121 (m ²)	430356H Price gr. A121 (m ²)	430368H Price gr. A154 (m ²)
sand-grey	430297H Price gr. A109 (m ²)	430309H Price gr. A109 (m ²)	430321H Price gr. A199 (m ²)	430333H Price gr. A199 (m ²)	430345H Price gr. A121 (m ²)	430357H Price gr. A121 (m ²)	430369H Price gr. A154 (m ²)
sand	430298H Price gr. A109 (m ²)	430310H Price gr. A109 (m ²)	430322H Price gr. A199 (m ²)	430334H Price gr. A199 (m ²)	430346H Price gr. A121 (m ²)	430358H Price gr. A121 (m ²)	430370H Price gr. A154 (m ²)
nutmeg	430299H Price gr. A109 (m ²)	430311H Price gr. A109 (m ²)	430323H Price gr. A199 (m ²)	430335H Price gr. A199 (m ²)	430347H Price gr. A121 (m ²)	430359H Price gr. A121 (m ²)	430371H Price gr. A154 (m ²)
platinum	430300H Price gr. A109 (m ²)	430312H Price gr. A109 (m ²)	430324H Price gr. A199 (m ²)	430336H Price gr. A199 (m ²)	430348H Price gr. A121 (m ²)	430360H Price gr. A121 (m ²)	430372H Price gr. A154 (m ²)
sand-beige	430301H Price gr. A109 (m ²)	430313H Price gr. A109 (m ²)	430325H Price gr. A199 (m ²)	430337H Price gr. A199 (m ²)	430349H Price gr. A121 (m ²)	430361H Price gr. A121 (m ²)	430373H Price gr. A154 (m ²)
brick	430302H Price gr. A109 (m ²)	430314H Price gr. A109 (m ²)	430326H Price gr. A199 (m ²)	430338H Price gr. A199 (m ²)	430350H Price gr. A121 (m ²)	430362H Price gr. A121 (m ²)	430374H Price gr. A154 (m ²)
clay	430303H Price gr. A109 (m ²)	430315H Price gr. A109 (m ²)	430327H Price gr. A199 (m ²)	430339H Price gr. A199 (m ²)	430351H Price gr. A121 (m ²)	430363H Price gr. A121 (m ²)	430375H Price gr. A154 (m ²)



¹ rectified

² Make-to-order production: return and/or cancellation of ordered products not possible.

³ 15 mm thick tiles can be supplied upon request.

All products: Color Shade Variation V2

Floor Tiles

60 x 60 cm¹

60 x 60 cm^{2/3/5}

60 x 60 cm¹

60 x 60 cm¹

60 x 90 cm¹

60 x 120 cm^{1/4}

60 x 120 cm^{1/4}

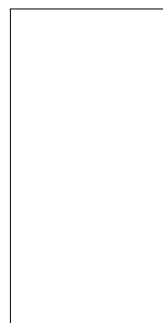
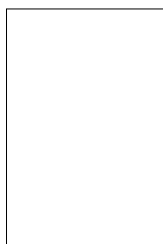
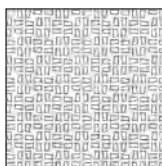
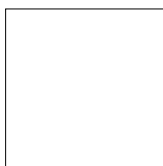

extra thick		Grid					
60 x 60 / 24 x 24	60 x 60 / 24 x 24	60 x 60 / 24 x 24	60 x 60 / 24 x 24	60 x 90 / 24 x 36	60 x 120 / 24 x 48	60 x 120 / 24 x 48	Nom. dim. - cm/in
597 x 597 x 10.5 mm	597 x 597 x 14 mm	597 x 597 x 10.5 mm	597 x 597 x 10.5 mm	597 x 897 x 10.5 mm	597 x 1197 x 10.5 mm	597 x 1197 x 10.5 mm	Work size
smooth, matt	smooth, matt	smooth, matt	profiled, matt	smooth, matt	smooth, matt	smooth, matt	Surface
2.778	2.778	2.778	2.778	1.851	1.389	1.389	m ² - pieces
23.769	31.669	23.769	23.769	23.367	23.821	23.821	m ² - kg
3	2	3	3	2	2	2	Bundle - pieces
1.080	0.720	1.080	1.080	1.080	1.441	1.441	Bundle - m ²
25.668	22.800	25.668	25.668	25.248	34.300	34.300	Bundle - kg
38.880	30.238	38.880	38.880	22.690	30.238	30.238	Pallet - m ²
924.048	957.600	924.048	924.048	530.208	720.300	720.300	Pallet - kg
Bla	Bla	Bla	Bla	Alb	Alb	Alb	Product standard
R10/A	R10	R11/B	R12V4	R10/A	R10/A	R11/B	Slip resistance
2 - 3	3 - 4	2 - 3	2 - 3	2 - 3	2 - 3	2 - 3	Stress group
430380H		430214H	430392H	430576H	430398H	430410H	anthracite
Price gr. A136 (m ²)		Price gr. A136 (m ²)	Price gr. A166 (m ²)	Price gr. A154 (m ²)	Price gr. A154 (m ²)	Price gr. A154 (m ²)	
430381H		430215H	430393H	430577H	430399H	430411H	basalt
Price gr. A136 (m ²)		Price gr. A136 (m ²)	Price gr. A166 (m ²)	Price gr. A154 (m ²)	Price gr. A154 (m ²)	Price gr. A154 (m ²)	
430382H	430200H	430216H	430394H	430578H	430400H	430412H	pebble
Price gr. A136 (m ²)		Price gr. A136 (m ²)	Price gr. A166 (m ²)	Price gr. A154 (m ²)	Price gr. A154 (m ²)	Price gr. A154 (m ²)	
430383H				430579H	430401H	430413H	stone
Price gr. A136 (m ²)				Price gr. A154 (m ²)	Price gr. A154 (m ²)	Price gr. A154 (m ²)	
430384H	430201H			430580H	430402H	430414H	sand-white
Price gr. A136 (m ²)				Price gr. A154 (m ²)	Price gr. A154 (m ²)	Price gr. A154 (m ²)	
430385H	430202H	430217H	430395H	430581H	430403H	430415H	sand-grey
Price gr. A136 (m ²)		Price gr. A136 (m ²)	Price gr. A166 (m ²)	Price gr. A154 (m ²)	Price gr. A154 (m ²)	Price gr. A154 (m ²)	
430386H		430218H	430396H	430582H	430404H	430416H	sand
Price gr. A136 (m ²)		Price gr. A136 (m ²)	Price gr. A166 (m ²)	Price gr. A154 (m ²)	Price gr. A154 (m ²)	Price gr. A154 (m ²)	
430387H				430583H	430405H	430417H	nutmeg
Price gr. A136 (m ²)				Price gr. A154 (m ²)	Price gr. A154 (m ²)	Price gr. A154 (m ²)	
430388H				430584H	430406H	430418H	platinum
Price gr. A136 (m ²)				Price gr. A154 (m ²)	Price gr. A154 (m ²)	Price gr. A154 (m ²)	
430389H		430219H	430397H	430585H	430407H	430419H	sand-beige
Price gr. A136 (m ²)		Price gr. A136 (m ²)	Price gr. A166 (m ²)	Price gr. A154 (m ²)	Price gr. A154 (m ²)	Price gr. A154 (m ²)	
430390H				430586H	430408H	430420H	brick
Price gr. A136 (m ²)				Price gr. A154 (m ²)	Price gr. A154 (m ²)	Price gr. A154 (m ²)	
430391H				430587H	430409H	430421H	clay
Price gr. A136 (m ²)				Price gr. A154 (m ²)	Price gr. A154 (m ²)	Price gr. A154 (m ²)	



1 rectified



2 conically rectified



3 Make-to-order production: return and/or cancellation of ordered products not possible.

⁴ High weight only to carry with two persons.

⁵ Prices are calculated project-specifically

All products: Color Shade Variation V2



Floor Tile^{1/2/3} Cove skirting, decorated

Internal
Corner

External
Corner

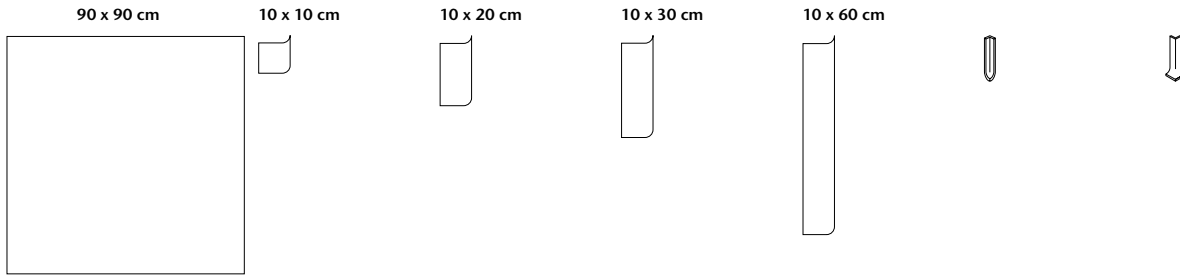

Nom. dim. - cm/in	90 x 90 / 36 x 36	10 x 10 / 4 x 4	10 x 20 / 4 x 8	10 x 30 / 4 x 12	10 x 60 / 4 x 24		
Work size	895 x 895 x 11 mm	100 x 97 x 6.5 mm	102 x 197 x 9 mm	102 x 297 x 9 mm	102 x 597 x 9 mm	102 x 20 x 9 mm	102 x 35 x 9 mm
Surface	smooth, matt	smooth, matt	smooth, matt	smooth, matt	smooth, matt	smooth, matt	smooth, matt
m ² /m - pieces	1.234/m ²	10.000/m	5.000/m	3.333/m	1.667/m		
m ² /m/pce. - kg	24.691/m ²	1.500/m	2.000/m	1.999/m	2.000/m	0.080/pieces	0.080/pieces
Bundle - pieces	2	40	20	16	16	18	12
Bundle - m ² /m	1.620/m ²	4.000/m	4.000/m	4.800/m	9.598/m		
Bundle - kg	40.018	6.000	8.000	9.600	19.200	1.440	0.960
Pallet - m ²	48.622						
Pallet - kg	1,200.540						
Product standard	Bla	Bla	Bla	Bla	Bla	Bla	Bla
Slip resistance	R10/A	R10/B	R10/A	R10/A	R10/A		
Stress group	2 - 3						
anthracite	430422 Price gr. A181 (m ²)	430564H Price gr. A411 (pce.)	430428H Price gr. A419 (pce.)	430440H Price gr. A425 (pce.)	430452H Price gr. A445 (pce.)	430480H Price gr. A418 (pce.)	430492H Price gr. A418 (pce.)
basalt	430423 Price gr. A181 (m ²)	430565H Price gr. A411 (pce.)	430429H Price gr. A419 (pce.)	430441H Price gr. A425 (pce.)	430453H Price gr. A445 (pce.)	430481H Price gr. A418 (pce.)	430493H Price gr. A418 (pce.)
pebble	430424 Price gr. A181 (m ²)	430566H Price gr. A411 (pce.)	430430H Price gr. A419 (pce.)	430442H Price gr. A425 (pce.)	430454H Price gr. A445 (pce.)	430482H Price gr. A418 (pce.)	430494H Price gr. A418 (pce.)
stone		430567H Price gr. A411 (pce.)	430431H Price gr. A419 (pce.)	430443H Price gr. A425 (pce.)	430455H Price gr. A445 (pce.)	430483H Price gr. A418 (pce.)	430495H Price gr. A418 (pce.)
sand-white		430568H Price gr. A411 (pce.)	430432H Price gr. A419 (pce.)	430444H Price gr. A425 (pce.)	430456H Price gr. A445 (pce.)	430484H Price gr. A418 (pce.)	430496H Price gr. A418 (pce.)
sand-grey	430425 Price gr. A181 (m ²)	430569H Price gr. A411 (pce.)	430433H Price gr. A419 (pce.)	430445H Price gr. A425 (pce.)	430457H Price gr. A445 (pce.)	430485H Price gr. A418 (pce.)	430497H Price gr. A418 (pce.)
sand	430426 Price gr. A181 (m ²)	430570H Price gr. A411 (pce.)	430434H Price gr. A419 (pce.)	430446H Price gr. A425 (pce.)	430458H Price gr. A445 (pce.)	430486H Price gr. A418 (pce.)	430498H Price gr. A418 (pce.)
nutmeg		430571H Price gr. A411 (pce.)	430435H Price gr. A419 (pce.)	430447H Price gr. A425 (pce.)	430459H Price gr. A445 (pce.)	430487H Price gr. A418 (pce.)	430499H Price gr. A418 (pce.)
platinum		430572H Price gr. A411 (pce.)	430436H Price gr. A419 (pce.)	430448H Price gr. A425 (pce.)	430460H Price gr. A445 (pce.)	430488H Price gr. A418 (pce.)	430500H Price gr. A418 (pce.)
sand-beige	430427 Price gr. A181 (m ²)	430573H Price gr. A411 (pce.)	430437H Price gr. A419 (pce.)	430449H Price gr. A425 (pce.)	430461H Price gr. A445 (pce.)	430489H Price gr. A418 (pce.)	430501H Price gr. A418 (pce.)
brick		430574H Price gr. A411 (pce.)	430438H Price gr. A419 (pce.)	430450H Price gr. A425 (pce.)	430462H Price gr. A445 (pce.)	430490H Price gr. A418 (pce.)	430502H Price gr. A418 (pce.)
clay		430575H Price gr. A411 (pce.)	430439H Price gr. A419 (pce.)	430451H Price gr. A425 (pce.)	430463H Price gr. A445 (pce.)	430491H Price gr. A418 (pce.)	430503H Price gr. A418 (pce.)



¹ without Hytect coating; with Protecta upgrading
³ Important: special pallet, no return, no exchange

For detail drawings of cove skirtings / internal corners / external corners refer to page 716

All products: Color Shade Variation V2

Shower Tub System^{1/2} **NEW**

10 x 10 cm



10 x 10 cm



				Strip	Corner	
				10 x 10 / 4 x 4	10 x 10 / 4 x 4	Nom. dim. - cm/in
				97 x 97 x 6.5 mm	97 x 97 x 6.5 mm	Work size
				smooth, matt	smooth, matt	Surface
				10.000		m - pieces
				1.700/m	0.170/pieces	m/pce. - kg
				16	4	Bundle - pieces
				1.600		Bundle - m
				2.720	0.680	Bundle - kg
				Bla	Bla	Product standard
				R10/B	R10/B	Slip resistance
				430064H	430070H	
				Price gr. A445 (pce.)	Price gr. A475 (pce.)	anthracite
				430065H	430071H	
				Price gr. A445 (pce.)	Price gr. A475 (pce.)	basalt
				430066H	430072H	
				Price gr. A445 (pce.)	Price gr. A475 (pce.)	pebble
				430067H	430073H	
				Price gr. A445 (pce.)	Price gr. A475 (pce.)	sand-grey
				430068H	430074H	
				Price gr. A445 (pce.)	Price gr. A475 (pce.)	sand
				430069H	430075H	
				Price gr. A445 (pce.)	Price gr. A475 (pce.)	sand-beige

¹ For details, refer to page 714

²  Make-to-order production: return and/or cancellation of ordered products not possible.



All products: Color Shade Variation V2

Stair Tiles with grooves³Stair Tile with
grooves
1/3/4/5Stair Tile with
bevel^{2/3}Stair Tile
with bevel &
grooves
2/3/4/5Riser^{2/3}

30 x 30 cm

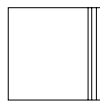
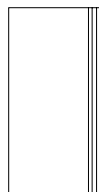
30 x 60 cm¹

60 x 120 cm

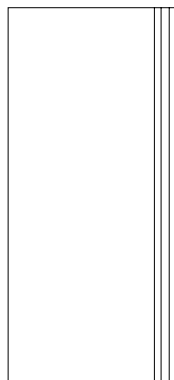

31 x 135 cm

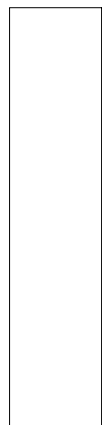

31 x 135 cm

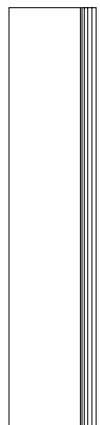

28 x 135 cm



Nom. dim. - cm/in	30 x 30 / 12 x 12	30 x 60 / 12 x 24	60 x 120 / 24 x 48	31 x 135 / 12 13/64 x 53 5/32	31 x 135 / 12 13/64 x 53 5/32	28 x 135 / 11 x 53 5/32
Work size	297 x 297 x 10.5 mm	297 x 597 x 10.5 mm	597 x 1197 x 10.5 mm	307 x 1347 x 10.5 mm	307 x 1347 x 10.5 mm	280 x 1347 x 10.5 mm
Surface	smooth, matt	smooth, matt	grooved, matt	smooth, matt	grooved, matt	smooth, matt
m - pieces	3.333	1.667	0.833	0.741	0.741	0.741
m - kg	6.943	6.968	14.286	7.321	7.321	6.676
Bundle - pieces	10	6	2	2	2	2
Bundle - m	3.000	3.599	2.400	2.699	2.699	2.699
Bundle - kg	20.830	25.080	34.300	19.760	19.760	18.020
Product standard	Bla	Bla	Alb	Alb	Alb	Alb
Slip resistance	R10/A	R10/A	R10/A	R10/A	R10/A	
Stress group	2 - 3	2 - 3	2-3	2 - 3	2-3	2 - 3
anthracite	430464H Price gr. A449 (pce.)	430504H Price gr. A458 (pce.)	430398H-TF Price gr. A593 (pce.)	430540H Price gr. A560 (pce.)	430540H-TF Price gr. A577 (pce.)	430552H Price gr. A528 (pce.)
basalt	430465H Price gr. A449 (pce.)	430505H Price gr. A458 (pce.)		430541H Price gr. A560 (pce.)		430553H Price gr. A528 (pce.)
pebble	430466H Price gr. A449 (pce.)	430506H Price gr. A458 (pce.)		430542H Price gr. A560 (pce.)		430554H Price gr. A528 (pce.)
stone	430467H Price gr. A449 (pce.)	430507H Price gr. A458 (pce.)		430543H Price gr. A560 (pce.)		430555H Price gr. A528 (pce.)
sand-white	430468H Price gr. A449 (pce.)	430508H Price gr. A458 (pce.)		430544H Price gr. A560 (pce.)		430556H Price gr. A528 (pce.)
sand-grey	430469H Price gr. A449 (pce.)	430509H Price gr. A458 (pce.)		430545H Price gr. A560 (pce.)		430557H Price gr. A528 (pce.)
sand	430470H Price gr. A449 (pce.)	430510H Price gr. A458 (pce.)		430546H Price gr. A560 (pce.)		430558H Price gr. A528 (pce.)
nutmeg	430471H Price gr. A449 (pce.)	430511H Price gr. A458 (pce.)		430547H Price gr. A560 (pce.)		430559H Price gr. A528 (pce.)
platinum	430472H Price gr. A449 (pce.)	430512H Price gr. A458 (pce.)		430548H Price gr. A560 (pce.)		430560H Price gr. A528 (pce.)
sand-beige	430473H Price gr. A449 (pce.)	430513H Price gr. A458 (pce.)		430549H Price gr. A560 (pce.)		430561H Price gr. A528 (pce.)
brick	430474H Price gr. A449 (pce.)	430514H Price gr. A458 (pce.)		430550H Price gr. A560 (pce.)		430562H Price gr. A528 (pce.)
clay	430475H Price gr. A449 (pce.)	430515H Price gr. A458 (pce.)		430551H Price gr. A560 (pce.)		430563H Price gr. A528 (pce.)



rectified

² Only rectified on the two short sides. The long side can not be rectified!³ Make-to-order production: return and/or cancellation of ordered products not possible.⁴ Other colors available on request.⁵ For details, refer to page 718

All products: Color Shade Variation V2

Stair Edges^{1/2/3/4/5}

Stair Edge with bevel^{2/3/4/5}

Skirting, rounded¹

4 x 60 cm



7.2 x 60 cm



7.2 x 120 cm



7.2 x 135 cm



7 x 30 cm ^{NEW}



7 x 60 cm



	4 x 60 / 1 5/8 x 24	7.2 x 60 / 2 7/8 x 24	7.2 x 120 / 2 7/8 x 48	7.2 x 135 / 2 7/8 x 53 5/32	7 x 30 / 2 13/16 x 12	7 x 60 / 2 13/16 x 24	Nom. dim. - cm/in
	40 x 597 x 10.5 mm	72 x 597 x 10.5 mm	72 x 1197 x 10.5 mm	72 x 1347 x 10.5 mm	70 x 297 x 10.5 mm	70 x 597 x 10.5 mm	Work size
	smooth, matt	smooth, matt	smooth, matt	smooth, matt	smooth, matt	smooth, matt	Surface
	1.667	1.667	0.833	0.741	3.333	1.667	m - pieces
	0.967	1.355	1.405	1.380	1.583	1.584	m - kg
	9	9	10	10	22	15	Bundle - pieces
	5.399	15.003	12.004	13.495	6.600	8.998	Bundle - m
	5.220	7.317	16.870	18.630	10.450	14.250	Bundle - kg
	Bla	Bla	Alb	Alb	Bla	Bla	Product standard
	R10/A	R10/A	R10/A	R10/A			Slip resistance
	2 - 3	2-3	2-3	2-3			Stress group
	430516H Price gr. A452 (pce.)	430340H-TK Price gr. A471 (pce.)	430398H-TK Price gr. A511 (pce.)	430540H-TK Price gr. A539 (pce.)	430080H Price gr. A419 (pce.)	430528H Price gr. A438 (pce.)	anthracite
	430517H Price gr. A452 (pce.)				430081H Price gr. A419 (pce.)	430529H Price gr. A438 (pce.)	basalt
	430518H Price gr. A452 (pce.)				430082H Price gr. A419 (pce.)	430530H Price gr. A438 (pce.)	pebble
	430519H Price gr. A452 (pce.)				430083H Price gr. A419 (pce.)	430531H Price gr. A438 (pce.)	stone
	430520H Price gr. A452 (pce.)				430084H Price gr. A419 (pce.)	430532H Price gr. A438 (pce.)	sand-white
	430521H Price gr. A452 (pce.)				430085H Price gr. A419 (pce.)	430533H Price gr. A438 (pce.)	sand-grey
	430522H Price gr. A452 (pce.)				430086H Price gr. A419 (pce.)	430534H Price gr. A438 (pce.)	sand
	430523H Price gr. A452 (pce.)				430087H Price gr. A419 (pce.)	430535H Price gr. A438 (pce.)	nutmeg
	430524H Price gr. A452 (pce.)				430088H Price gr. A419 (pce.)	430536H Price gr. A438 (pce.)	platinum
	430525H Price gr. A452 (pce.)				430089H Price gr. A419 (pce.)	430537H Price gr. A438 (pce.)	sand-beige
	430526H Price gr. A452 (pce.)				430090H Price gr. A419 (pce.)	430538H Price gr. A438 (pce.)	brick
	430527H Price gr. A452 (pce.)				430091H Price gr. A419 (pce.)	430539H Price gr. A438 (pce.)	clay



² Only rectified on the two short sides. The long side can not be rectified!

³ Make-to-order production: return and/or cancellation of ordered products not possible.

⁴ Other colors available on request.

⁵ For details, refer to page 718

All products: Color Shade Variation V2



Guide Tiles^{1/2/3}



30 x 30 cm



30 x 30 cm



Nom. dim. - cm/in	30 x 30 / 12 x 12	30 x 30 / 12 x 12				
Work size	297 x 297 x 10.5 mm	297 x 297 x 10.5 mm				
Surface	ribbed structure	knob structure				
m - pieces	3.333	3.333				
m - kg	7.999	7.999				
Bundle - pieces	8	8				
Bundle - m	2.400	2.400				
Bundle - kg	19.200	19.200				
Product standard	Bla	Bla				
Slip resistance	R11	R11				
Stress group	3	3				
anthracite	430304H-R <i>Price gr. A455 (pce.)</i>	430304H-N <i>Price gr. A539 (pce.)</i>				
platinum	430312H-R <i>Price gr. A455 (pce.)</i>	430312H-N <i>Price gr. A539 (pce.)</i>				



- ¹ Complying with the requirements of DIN 32984
- ² Other color combinations on request, taking into account the luminance contrast specifications from DIN 32984.
- ³  Make-to-order production: return and/or cancellation of ordered products not possible.

All products: Color Shade Variation V2

Grooved tiles, 12,5 mm thick, for continuing the pool edge system "Finland II"^{1/2}

NEW

Gutter Tiles ^{1/2/3}

NEW

25 x 50 cm

25 x 25 cm

12.5 x 25 cm

50 x 25 cm

50 x 25 cm

50 x 25 cm

50 x 25 cm

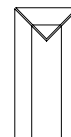
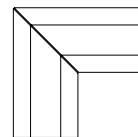
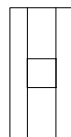
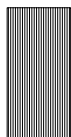

50 x 25 / 20 x 10	25 x 25 / 10 x 10	12.5 x 25 / 5 x 10	50 x 25 / 20 x 10	50 x 25 / 20 x 10	50 x 25 / 20 x 10	50 x 25 / 20 x 10	Nom. dim. - cm/in
494 x 244 x 12.5 mm	244 x 244 x 12.5 mm	119 x 244 x 12.5 mm	494 x 244 x 14 mm	494 x 244 x 14 mm	(2x) 494 x 244 x 14 mm	494 x 244 x 14 mm	Work size
grooved, matt	grooved, matt	grooved, matt	smooth, matt	smooth, matt	smooth, matt	smooth, matt	Surface
2.000	4.000	8.000	2.000	2.000	2.000	2.000	m - pieces
3.550/pieces	1.775/pieces	0.888/pieces	2.500/pieces	2.300/pieces	3.800/pair	2.500/pieces	pce./pair - kg
6 pieces	9 pieces	21 pieces	5 pieces	5 pieces	2 pairs	5 pairs	Bundle - pieces/pair
3.000	2.250	2.625	2.500	12.500	7.600	12.500	Bundle - m
21.300	15.975	18.648	12.500	11.500	7.600	12.500	Bundle - kg
							Pallet - m ²
							Pallet - kg
Alb	Alb	Alb	Alb	Alb	Alb	Alb	Product standard
R11/C	R11/C	R11/C	R11/B	R11/B	R11/B	R11/B	Slip resistance
							Stress group
435601H	435613H	435625H	435637H	435649H	435661H	435673H	anthracite
Price gr. A560 (pce.)	Price gr. A480 (pce.)	Price gr. A430 (pce.)	Price gr. A519 (pce.)	Price gr. A593 (pce.)	Price gr. A645 (pair)	Price gr. A593 (pair)	
435602H	435614H	435626H	435638H	435650H	435662H	435674H	basalt
Price gr. A560 (pce.)	Price gr. A480 (pce.)	Price gr. A430 (pce.)	Price gr. A519 (pce.)	Price gr. A593 (pce.)	Price gr. A645 (pair)	Price gr. A593 (pair)	
435603H	435615H	435627H	435639H	435651H	435663H	435675H	pebble
Price gr. A560 (pce.)	Price gr. A480 (pce.)	Price gr. A430 (pce.)	Price gr. A519 (pce.)	Price gr. A593 (pce.)	Price gr. A645 (pair)	Price gr. A593 (pair)	
435604H	435616H	435628H	435640H	435652H	435664H	435676H	stone
Price gr. A560 (pce.)	Price gr. A480 (pce.)	Price gr. A430 (pce.)	Price gr. A519 (pce.)	Price gr. A593 (pce.)	Price gr. A645 (pair)	Price gr. A593 (pair)	
435605H	435617H	435629H	435641H	435653H	435665H	435677H	sand-white
Price gr. A560 (pce.)	Price gr. A480 (pce.)	Price gr. A430 (pce.)	Price gr. A519 (pce.)	Price gr. A593 (pce.)	Price gr. A645 (pair)	Price gr. A593 (pair)	
435606H	435618H	435630H	435642H	435654H	435666H	435678H	sand-grey
Price gr. A560 (pce.)	Price gr. A480 (pce.)	Price gr. A430 (pce.)	Price gr. A519 (pce.)	Price gr. A593 (pce.)	Price gr. A645 (pair)	Price gr. A593 (pair)	
435607H	435619H	435631H	435643H	435655H	435667H	435679H	sand
Price gr. A560 (pce.)	Price gr. A480 (pce.)	Price gr. A430 (pce.)	Price gr. A519 (pce.)	Price gr. A593 (pce.)	Price gr. A645 (pair)	Price gr. A593 (pair)	
435608H	435620H	435632H	435644H	435656H	435668H	435680H	nutmeg
Price gr. A560 (pce.)	Price gr. A480 (pce.)	Price gr. A430 (pce.)	Price gr. A519 (pce.)	Price gr. A593 (pce.)	Price gr. A645 (pair)	Price gr. A593 (pair)	
435609H	435621H	435633H	435645H	435657H	435669H	435681H	platinum
Price gr. A560 (pce.)	Price gr. A480 (pce.)	Price gr. A430 (pce.)	Price gr. A519 (pce.)	Price gr. A593 (pce.)	Price gr. A645 (pair)	Price gr. A593 (pair)	
435610H	435622H	435634H	435646H	435658H	435670H	435682H	sand-beige
Price gr. A560 (pce.)	Price gr. A480 (pce.)	Price gr. A430 (pce.)	Price gr. A519 (pce.)	Price gr. A593 (pce.)	Price gr. A645 (pair)	Price gr. A593 (pair)	
435611H	435623H	435635H	435647H	435659H	435671H	435683H	brick
Price gr. A560 (pce.)	Price gr. A480 (pce.)	Price gr. A430 (pce.)	Price gr. A519 (pce.)	Price gr. A593 (pce.)	Price gr. A645 (pair)	Price gr. A593 (pair)	
435612H	435624H	435636H	435648H	435660H	435672H	435684H	clay
Price gr. A560 (pce.)	Price gr. A480 (pce.)	Price gr. A430 (pce.)	Price gr. A519 (pce.)	Price gr. A593 (pce.)	Price gr. A645 (pair)	Price gr. A593 (pair)	

¹ Make-to-order production: return and/or cancellation of ordered products not possible.

² Short edge rectified

³ On request, also available in a length of 497 mm.



All products: Color Shade Variation V2

Patio Tiles ^{1/4} **NEW**

60 x 60 cm²

60 x 60 cm³

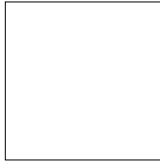

Surface decor "Square"

Nom. dim. - cm/in	60 x 60 / 24 x 24	60 x 60 / 24 x 24				
Work size	597 x 597 x 20 mm	597 x 597 x 20 mm				
Surface	smooth, matt	smooth, matt				
m ² - pieces	2,778	2,778				
m ² - kg	45.273	45.273				
Bundle - pieces	2	2				
Bundle - m ²	0.720	0.720				
Bundle - kg	32.500	32.500				
Pallet - m ²	21.598	21.598				
Pallet - kg	977.820	977.820				
Product standard	Bla	Bla				
Slip resistance	R11/B	R11/B				
Stress group	4	4				
anthracite	430093H Price gr. A239 (m ²)					
basalt	430094H Price gr. A239 (m ²)	430115H Price gr. A239 (m ²)				
pebble	430095H Price gr. A239 (m ²)					
sand-grey	430096H Price gr. A239 (m ²)	430116H Price gr. A239 (m ²)				
sand	430097H Price gr. A239 (m ²)					
sand-beige	430098H Price gr. A239 (m ²)	430117H Price gr. A239 (m ²)				



¹  rectified

² Colour Shade Variation V2

³ Colour Shade Variation V3

⁴ High weight only to carry with two persons.

Special Pieces - Patio Tiles¹ **NEW**

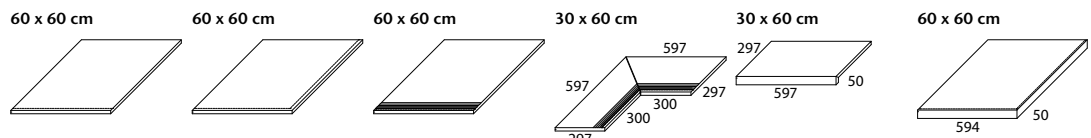

<i>Patio tile with rounded edge on one side</i>	<i>Patio tile with corner-adjacent rounded edges</i>	<i>Patio tile with rounded edge on one side and grooves</i>	<i>Patio tile with rounded edge on one side and grooves as corner solution (2 pieces)</i>	<i>Patio tile step with nosing</i>	<i>Patio tile step with nosing as corner solution</i>
60 x 60 / 24 x 24	60 x 60 / 24 x 24	60 x 60 / 24 x 24	30 x 60 / 12 x 24	30 x 60 / 12 x 24	60 x 60 / 24 x 24
597 x 597 x 20 mm	597 x 597 x 20 mm	597 x 597 x 20 mm	297 x 597 x 20 mm	297/50 x 597 x 20 mm	594/50 x 594 x 20 mm
smooth, matt	smooth, matt	smooth, matt	smooth, matt	smooth, matt	smooth, matt
1.667	1.667	1.667		1.667	
27.167/m	27.167/m	27.167/m	16.297/pair	15.868/m	
1 piece	1 piece	1 piece	1 pair	1 piece	1 piece
0.600	0.600	0.600			
16.297	16.297	16.297	16.297	9.519	19.027
Bla	Bla	Bla	Bla	Bla	Bla
R11/B	R11/B	R11/B	R11/B	R11/B	R11/B
4	4	4	4	4	4
430093H-RE	430093H-RZ	430093H-RER	430093H-RERZ	430093H-SE	430093H-SZ
Price gr. A672 (pce.)	Price gr. A731 (pce.)	Price gr. A689 (pce.)	Price gr. A792 (pce.)	Price gr. A689 (pce.)	Price gr. A784 (pce.)



Nom. dim. - cm/in
Work size
Surface
m - pieces
m/pair - kg
Bundle - pieces/pair
Bundle - m
Bundle - kg
Pallet - m
Pallet - kg
Product standard
Slip resistance
Stress group
anthracite

¹  Make-to-order production: return and/or cancellation of ordered products not possible.

Other versions regarding edge formation and/or formats possible on request.

Minimum order quantity: 10 linear metres per order (division into several articles possible), smaller quantities after separate price calculation.







Experience diversity

Ascona is made for spas, wellness areas and swimming pools in hotels, but also for private homes. This is also due to the diversity of this series. Already visually, with mosaics and oblong formats, small and large formats for walls and floors as well as the fine selection of colors, one has a wide range for design. However, the series also impresses with its functional possibilities and technical solutions, especially for all swimming pool areas or spas – by the way, indoors and outdoors, in entrance areas as well as in rooms where visitors walk barefoot or in dedicated wet areas. Thanks to clear lines and grounded colors, a wide variety of style worlds can be created. Puristic architecture is just as possible as classic or modern country house designs. The Ascona series can be perfectly combined with our mosaic series Marble & More.



R10/A R10/B R11/B R11/C



pearl



mud



stone

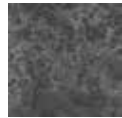

graphite



shell

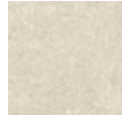

sand



Floor tile 15 x 15 cm, 6 x 6 in, structured, R10/B



Floor tile 25 x 50 cm, 10 x 20 in, structured, R11/B



Floor tile 30 x 60 cm, 12 x 24 in, structured, R10/A
Floor tile 30 x 60 cm, 12 x 24 in, structured, R11/B



Grid profile tile 25 x 50 cm, 10 x 20 in, relief, R11/C

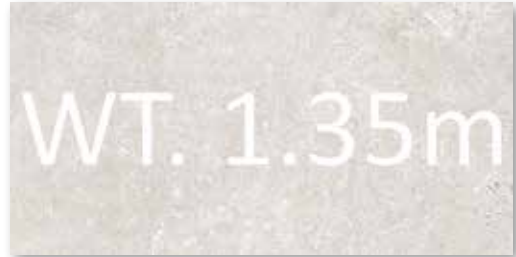

Letter tile 25 x 50 cm, 10 x 20 in, structured, R11/B

Mosaic 5 x 5 cm, 2 x 2 in



Mosaic sheet 30 x 30 cm, 2 x 2 in, pearl, structured, R10/B



Mosaic sheet 30 x 30 cm, 2 x 2 in, mud, structured, R10/B



Mosaic sheet 30 x 30 cm, 2 x 2 in, stone, structured, R10/B

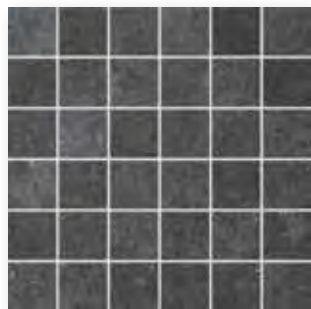

Mosaic sheet 30 x 30 cm, 2 x 2 in, graphite, structured, R10/B



Mosaic sheet 30 x 30 cm, 2 x 2 in, shell, structured, R10/B



Mosaic sheet 30 x 30 cm, 2 x 2 in, sand, structured, R10/B

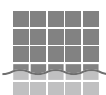

Mosaics glued thermoplastically on back of AGROB BUCHTAL can be used not only in dry zones but also without any problems in underwater areas (e.g. swimming pools/whirlpools) as well as in permanently wet areas (e.g. pool surrounds/showers).



Floor tile 60 x 60 cm, 24 x 24 in, structured, R10/A
 Floor tile 60 x 60 cm, 24 x 24 in, structured, R11/B



Cove skirting, decorated, 10 x 50 cm, 4 x 20 in



Cove skirting, decorated, 10 x 60 cm, 4 x 24 in



Skirting, cut, 6 x 50 cm, 2 3/8 x 20 in



Skirting, cut, 6 x 60 cm, 2 3/8 x 24 in



Stair tile with bevel 31 x 135 cm, 12.4 x 54 in, (with grooves), structured, R10/A



Stair tile with bevel 31 x 135 cm, 12.4 x 54 in, structured, R10/A



Riser 28 x 135 cm, 12.2 x 54 in, structured



pearl



mud



stone

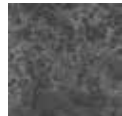

graphite



shell

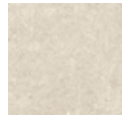

sand



Floor tile 12.5 x 12.5 cm, 5 x 5 in, structured, R11/B



Floor tile 12.5 x 25 cm, 5 x 10 in, structured, R11/B

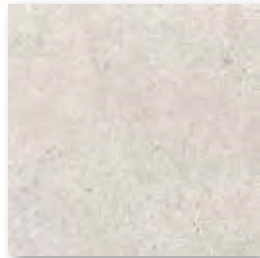

Floor tile 25 x 25 cm, 10 x 10 in, structured, R11/B



Floor tile 25 x 50 cm, 10 x 20 in, structured, R11/B



Wall tile 12.5 x 25 cm, 5 x 10 in, structured



Wall tile 25 x 50 cm, 10 x 20 in, structured

Grid profile



Grid profile tile 12.5 x 12.5 cm, 5 x 5 in, relief, R11/C



Grid profile tile 12.5 x 25 cm, 5 x 10 in, relief, R11/C



Grid profile tile 25 x 25 cm, 10 x 10 in, relief, R11/C



Grid profile tile 25 x 50 cm, 10 x 20 in, relief, R11/C



Grooved tile 12.5 x 25 cm, 5 x 10 in, grooved, R11/C



Grooved tile 25 x 25 cm, 10 x 10 in, grooved, R11/C



Grooved tile 50 x 25 cm, 10 x 20 in, grooved, R11/C



Cove skirting, decorated, 10 x 25 cm, 4 x 10 in

Gutter tile
(trough depth 5 mm)



Gutter tile*, 50 x 25 cm, 10 x 20 in structured, R11/B



Gutter tile, mitred pair structured, R11/B



Gutter tile with outlet structured, R11/B



Terminal piece structured, R11/B

* For details, refer to the chapter Pool + Spa, pages 444 and the following (make-to-order production).



pearl



mud



stone

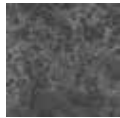

graphite

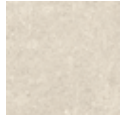

sand



Patio tile 50 x 100 cm, 20 x 40 in, structured, R11/B



Patio tile 60 x 90 cm, 24 x 36 in, structured, R11/B

Floor Tiles – joint 3 mm

Mosaic¹

Floor Tiles

5 x 5 cm

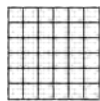

15 x 15 cm



25 x 50 cm²



25 x 50 cm^{2/3}



30 x 60 cm²



30 x 60 cm²

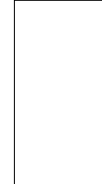

Mosaic, glued
thermoplastically
on back
Sheet: 297 x 297 mm

Grid profile tile



	5 x 5 / 2 x 2	15 x 15 / 6 x 6	25 x 50 / 10 x 20	25 x 50 / 10 x 20	30 x 60 / 12 x 24	30 x 60 / 12 x 24	Nom. dim. - cm/in
	47 x 47 x 6.5 mm	147 x 147 x 8 mm	247 x 497 x 8 mm	247 x 497 x 8 mm	297 x 597 x 8 mm	297 x 597 x 8 mm	Work size
	structured, matt	structured, matt	structured, matt	relief, matt	structured, matt	structured, matt	Surface
	11 sheets	44.444	8.000	8.000	5.556	5.556	m ² - pieces
	12.331	17.555	17.040	17.040	17.413	17.413	m ² - kg
	11	35	9	9	6	6	Bundle - pieces
	1.000	0.788	1.125	1.125	1.080	1.080	Bundle - m ²
	12.331	13.825	19.170	19.170	18.804	18.804	Bundle - kg
	64.000	63.001	40.500	40.500	43.197	43.197	Pallet - m ²
	789.184	1,106.000	690.120	690.120	752.160	752.160	Pallet - kg
	Bla	Bla	Alb	Alb	Alb	Alb	Product standard
	R10/B	R10/B	R11/B	R11/C	R10/A	R11/B	Slip resistance
	2	2	2	2	2	2	Stress group
	430701H Price gr. A226 (m ²)	430705H Price gr. A154 (m ²)	430709H Price gr. A166 (m ²)	430713H Price gr. A187 (m ²)	430721H Price gr. A148 (m ²)	430725H Price gr. A154 (m ²)	pearl
	430702H Price gr. A226 (m ²)	430706H Price gr. A154 (m ²)	430710H Price gr. A166 (m ²)	430714H Price gr. A187 (m ²)	430722H Price gr. A148 (m ²)	430726H Price gr. A154 (m ²)	mud
	430703H Price gr. A226 (m ²)	430707H Price gr. A154 (m ²)	430711H Price gr. A166 (m ²)	430715H Price gr. A187 (m ²)	430723H Price gr. A148 (m ²)	430727H Price gr. A154 (m ²)	stone
	430704H Price gr. A226 (m ²)	430708H Price gr. A154 (m ²)	430712H Price gr. A166 (m ²)	430716H Price gr. A187 (m ²)	430724H Price gr. A148 (m ²)	430728H Price gr. A154 (m ²)	graphite
	431501H Price gr. A226 (m ²)	431503H Price gr. A154 (m ²)	431505H Price gr. A166 (m ²)	431507H Price gr. A187 (m ²)	431509H Price gr. A148 (m ²)	431511H Price gr. A154 (m ²)	shell NEW
	431502H Price gr. A226 (m ²)	431504H Price gr. A154 (m ²)	431506H Price gr. A166 (m ²)	431508H Price gr. A187 (m ²)	431510H Price gr. A148 (m ²)	431512H Price gr. A154 (m ²)	sand NEW



2 rectified

3 Make-to-order production: return and/or cancellation of ordered products not possible.



All products: Color Shade Variation V3

Floor Tiles – joint 3 mm

Floor Tiles¹Stair Tile with
grooves^{2/3}Stair Tile^{2/3}Riser^{2/3}

60 x 60 cm



60 x 60 cm

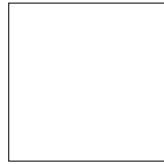

31 x 135 cm



31 x 135 cm



28 x 135 cm



Nom. dim. - cm/in	60 x 60 / 24 x 24	60 x 60 / 24 x 24	31 x 135 / 12 13/64 x 53 5/32	31 x 135 / 12 13/64 x 53 5/32	28 x 135 / 11 x 53 5/32		
Work size	597 x 597 x 8 mm	597 x 597 x 8 mm	307 x 1347 x 10.5 mm	307 x 1347 x 10.5 mm	280 x 1347 x 10.5 mm		
Surface	structured, matt	structured, matt	structured, matt	structured, matt	structured, matt		
m ² /m - pieces	2.778/m ²	2.778/m ²	0.741/m	0.741/m	0.741/m		
m ² /m - kg	18.001/m ²	18.001/m ²	7.321/m	7.321/m	6.676/m		
Bundle - pieces	4	4	2	2	2		
Bundle - m ² /m	1.440/m ²	1.440/m ²	2.669/m	2.669/m	2.669/m		
Bundle - kg	25.920	25.920	19.760	19.760	18.020		
Pallet - m ²	43.197	43.197					
Pallet - kg	777.600	777.600					
Product standard	Alb	Alb	Alb	Alb	Alb		
Slip resistance	R10/A	R11/B	R10/A	R10/A			
Stress group	2	2	2 - 3	2 - 3	2 - 3		
pearl	430729H Price gr. A166 (m ²)	430733H Price gr. A178 (m ²)	430980H Price gr. A577 (pce.)	430745H Price gr. A560 (pce.)	430749H Price gr. A528 (pce.)		
mud	430730H Price gr. A166 (m ²)	430734H Price gr. A178 (m ²)	430981H Price gr. A577 (pce.)	430746H Price gr. A560 (pce.)	430750H Price gr. A528 (pce.)		
stone	430731H Price gr. A166 (m ²)	430735H Price gr. A178 (m ²)	430982H Price gr. A577 (pce.)	430747H Price gr. A560 (pce.)	430751H Price gr. A528 (pce.)		
graphite	430732H Price gr. A166 (m ²)	430736H Price gr. A178 (m ²)	430983H Price gr. A577 (pce.)	430748H Price gr. A560 (pce.)	430752H Price gr. A528 (pce.)		
shell NEW	431513H Price gr. A166 (m ²)	431515H Price gr. A178 (m ²)	431517H Price gr. A577 (pce.)	431519H Price gr. A560 (pce.)	431521H Price gr. A528 (pce.)		
sand NEW	431514H Price gr. A166 (m ²)	431516H Price gr. A178 (m ²)	431518H Price gr. A577 (pce.)	431520H Price gr. A560 (pce.)	431522H Price gr. A528 (pce.)		



rectified



Make-to-order production: return and/or cancellation of ordered products not possible.

³ Only rectified on the two short sides. The long side can not be rectified!

All products: Color Shade Variation V3

Cove skirting, decorated^{1/2/4}

10 x 50 cm

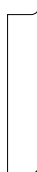

10 x 60 cm



Skirting, cut¹

6 x 50 cm



6 x 60 cm



Letter Tile^{1/2/3}

25 x 50 cm

WT. 1.35m



	10 x 50 / 4 x 20	10 x 60 / 4 x 24	6 x 50 / 2 3/8 x 20	6 x 60 / 2 3/8 x 24	25 x 50 / 10 x 20	
	100 x 497/35 x 9 mm	100 x 597/35 x 9 mm	60 x 497 x 8 mm	60 x 597 x 8 mm	247 x 497 x 8 mm	Nom. dim. - cm/in
	structured, matt	structured, matt	structured, matt	structured, matt	structured, matt	Work size
	2.000	1.667	2.000	1.667	2.000	Surface
	2.000/m	2.000/m	1.098/m	1.100/m	2.130/pieces	m - pieces
	20	20	30	34		m/pce. - kg
	10.000	12.000	15.000	20.396		Bundle - pieces
	20.000	24.000	16.470	22.440		Bundle - m
						Bundle - kg
						Pallet - m ²
						Pallet - kg
	Alb	Alb	Alb	Alb	Alb	Product standard
					R11/B	Slip resistance
					2	Stress group
	430741H	430737H	430984H	430988H	430717H	pearl
	Price gr. A441 (pce.)	Price gr. A445 (pce.)	Price gr. A434 (pce.)	Price gr. A434 (pce.)	Price gr. A668 (pce.)	
	430742H	430738H	430985H	430989H	430718H	mud
	Price gr. A441 (pce.)	Price gr. A445 (pce.)	Price gr. A434 (pce.)	Price gr. A434 (pce.)	Price gr. A668 (pce.)	
	430743H	430739H	430986H	430990H	430719H	stone
	Price gr. A441 (pce.)	Price gr. A445 (pce.)	Price gr. A434 (pce.)	Price gr. A434 (pce.)	Price gr. A668 (pce.)	
	430744H	430740H	430987H	430991H	430720H	graphite
	Price gr. A441 (pce.)	Price gr. A445 (pce.)	Price gr. A434 (pce.)	Price gr. A434 (pce.)	Price gr. A668 (pce.)	
	431523H	431525H	431527H	431529H	431531H	shell
	Price gr. A441 (pce.)	Price gr. A445 (pce.)	Price gr. A434 (pce.)	Price gr. A434 (pce.)	Price gr. A668 (pce.)	
	431524H	431526H	431528H	431530H	431532H	sand
	Price gr. A441 (pce.)	Price gr. A445 (pce.)	Price gr. A434 (pce.)	Price gr. A434 (pce.)	Price gr. A668 (pce.)	

¹  rectified

²  Make-to-order production: return and/or cancellation of ordered products not possible.

³ Only figures/letters in color 91 are available.

⁴ The cove skirting, decorated complies with DIN EN 14411, group Al_b, glazed (GL)

All products: Color Shade Variation V3



Wall and Floor Tiles – 6 mm joint

Wall Tile Floor Tiles



12.5 x 25 cm



12.5 x 12.5 cm²



12.5 x 12.5 cm^{1/2}



12.5 x 25 cm



12.5 x 25 cm¹



25 x 25 cm



25 x 25 cm¹



Nom. dim. - cm/in	Grid profile tile			Grid profile tile			Grid profile tile
	12.5 x 25 / 5 x 10	12.5 x 12.5 / 5 x 5	12.5 x 12.5 / 5 x 5	12.5 x 25 / 5 x 10	12.5 x 25 / 5 x 10	25 x 25 / 10 x 10	25 x 25 / 10 x 10
Work size	119 x 244 x 8 mm	119 x 119 x 8 mm	119 x 119 x 8 mm	119 x 244 x 8 mm	119 x 244 x 8 mm	244 x 244 x 8 mm	244 x 244 x 8 mm
Surface	structured, matt	structured, matt	relief, matt	structured, matt	relief, matt	structured, matt	relief, matt
m ² - pieces	32.000	64.000	64.000	32.000	32.000	16.000	16.000
m ² - kg	15.680	15.360	15.360	15.680	15.680	16.960	16.800
Bundle - pieces	33	66	66	33	33	14	14
Bundle - m ²	1.031	1.031	1.031	1.031	1.031	0.875	0.875
Bundle - kg	16.170	15.840	15.840	16.170	16.170	14.840	14.700
Pallet - m ²	86.625	86.625	86.625	86.625	86.625	70.875	70.875
Pallet - kg	1,358.280	1,330.560	1,330.560	1,358.280	1,358.280	1,202.040	1,190.700
Product standard	Alb	Alb	Alb	Alb	Alb	Alb	Alb
Slip resistance	-	R11/B	R11/C	R11/B	R11/C	R11/B	R11/C
Stress group	2	2	2	2	2	2	2
pearl	430761H Price gr. A127 (m ²)	430753H Price gr. A166 (m ²)	<i>430757H</i> <i>Price gr. A166 (m²)</i>	430763H Price gr. A136 (m ²)	<i>430767H</i> <i>Price gr. A148 (m²)</i>	430771H Price gr. A175 (m ²)	<i>430775H</i> <i>Price gr. A142 (m²)</i>
mud		430754H Price gr. A166 (m ²)	<i>430758H</i> <i>Price gr. A166 (m²)</i>	430764H Price gr. A136 (m ²)	<i>430768H</i> <i>Price gr. A148 (m²)</i>	430772H Price gr. A175 (m ²)	<i>430776H</i> <i>Price gr. A142 (m²)</i>
stone		430755H Price gr. A166 (m ²)	<i>430759H</i> <i>Price gr. A166 (m²)</i>	430765H Price gr. A136 (m ²)	<i>430769H</i> <i>Price gr. A148 (m²)</i>	430773H Price gr. A175 (m ²)	<i>430777H</i> <i>Price gr. A142 (m²)</i>
graphite	430762H Price gr. A127 (m ²)	430756H Price gr. A166 (m ²)	<i>430760H</i> <i>Price gr. A166 (m²)</i>	430766H Price gr. A136 (m ²)	<i>430770H</i> <i>Price gr. A148 (m²)</i>	430774H Price gr. A175 (m ²)	<i>430778H</i> <i>Price gr. A142 (m²)</i>
shell	431533H Price gr. A127 (m ²)	431534H Price gr. A166 (m ²)	<i>431536H</i> <i>Price gr. A166 (m²)</i>	431538H Price gr. A136 (m ²)	<i>431540H</i> <i>Price gr. A148 (m²)</i>	431542H Price gr. A175 (m ²)	<i>431544H</i> <i>Price gr. A142 (m²)</i>
sand	431535H Price gr. A166 (m ²)	431537H Price gr. A166 (m ²)	<i>431539H</i> <i>Price gr. A166 (m²)</i>	431539H Price gr. A136 (m ²)	<i>431541H</i> <i>Price gr. A148 (m²)</i>	431543H Price gr. A175 (m ²)	<i>431545H</i> <i>Price gr. A142 (m²)</i>



¹  Make-to-order production: return and/or cancellation of ordered products not possible.

² Supplied as double-tiles; to be broken by customer.

All products: Color Shade Variation V3

Wall Tile²

Floor Tiles²

Grooved Tiles 12,5 mm thick,
for continuing the Pool Edge System
„Finland II“^{1/3}

25 x 50 cm

25 x 50 cm

25 x 50 cm¹



50 x 25 cm

25 x 25 cm

12.5 x 25 cm

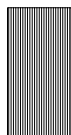

Grid profile tile

25 x 50 / 10 x 20	25 x 50 / 10 x 20	25 x 50 / 10 x 20	50 x 25 / 20 x 10	25 x 25 / 10 x 10	12.5 x 25 / 5 x 10	Nom. dim. - cm/in
244 x 494 x 8 mm	244 x 494 x 8 mm	244 x 494 x 8 mm	494 x 244 x 12.5 mm	244 x 244 x 12.5 mm	119 x 244 x 12.5 mm	Work size - mm
structured, matt	structured, matt	relief, matt	grooved, matt	grooved, matt	grooved, matt	Surface
8.000/m ²	8.000/m ²	8.000/m ²	2.000/m	4.000/m	8.000/m	m ² /m - pieces
17.040/m ²	17.040/m ²	17.040/m ²	3.550/pieces	1.775/pieces	0.888/pieces	m ² /St. - kg
9	9	9	6	9	21	Bundle - pieces
1.125/m ²	1.125/m ²	1.125/m ²	3.000/m	2.250/m	2.625/m	Bundle - m ² / m
19.170	19.170	19.170	21.300	15.975	18.648	Bundle - kg
40.500	40.500	40.500				Pallet - m ²
690.120	690.120	690.120				Pallet - kg
Alb	Alb	Alb	Alb	Alb	Alb	Product standard
-	R11/B	R11/C	R11/C	R11/C	R11/C	Slip resistance
-	2	2				Stress group
430779H	430781H	<i>430785H</i>	<i>430789H</i>	<i>430793H</i>	<i>430802H</i>	pearl
Price gr. A154 (m ²)	Price gr. A166 (m ²)	Price gr. A187 (m ²)	Price gr. A560 (pce.)	Price gr. A480 (pce.)	Price gr. A430 (pce.)	
	430782H	<i>430786H</i>	<i>430790H</i>	<i>430794H</i>	<i>430803H</i>	mud
	Price gr. A166 (m ²)	Price gr. A187 (m ²)	Price gr. A560 (pce.)	Price gr. A480 (pce.)	Price gr. A430 (pce.)	
	430783H	<i>430787H</i>	<i>430791H</i>	<i>430795H</i>	<i>430804H</i>	stone
	Price gr. A166 (m ²)	Price gr. A187 (m ²)	Price gr. A560 (pce.)	Price gr. A480 (pce.)	Price gr. A430 (pce.)	
430780H	430784H	<i>430788H</i>	<i>430792H</i>	<i>430796H</i>	<i>430805H</i>	graphite
Price gr. A154 (m ²)	Price gr. A166 (m ²)	Price gr. A187 (m ²)	Price gr. A560 (pce.)	Price gr. A480 (pce.)	Price gr. A430 (pce.)	
431546H	431547H	<i>431549H</i>	<i>431551H</i>	<i>431553H</i>	<i>431555H</i>	shell NEW
Price gr. A154 (m ²)	Price gr. A166 (m ²)	Price gr. A187 (m ²)	Price gr. A560 (pce.)	Price gr. A480 (pce.)	Price gr. A430 (pce.)	
	431548H	<i>431550H</i>	<i>431552H</i>	<i>431554H</i>	<i>431556H</i>	sand NEW
	Price gr. A166 (m ²)	Price gr. A187 (m ²)	Price gr. A560 (pce.)	Price gr. A480 (pce.)	Price gr. A430 (pce.)	

¹ Make-to-order production: return and/or cancellation of ordered products not possible.

² rectified

³ Short edge rectified

All products: Color Shade Variation V3



Cove skirting, decorated^{1/3/4}

10 x 25 cm



Gutter Tiles^{2/5}

50 x 25 cm



50 x 25 cm

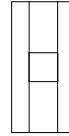

50 x 25 cm

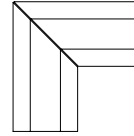

50 x 25 cm

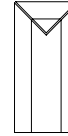

	10 x 25 / 4 x 10	Gutter tile	50 x 25 / 20 x 10	Gutter tile with outlet 110 / 110 mm	Gutter tile, mitred pair	Gutter tile, terminal piece
Nom. dim. - cm/in	100 x 244 / 35 x 9 mm	494 x 244 x 14 mm	494 x 244 x 14 mm	(2x) 494 x 244 x 14 mm	494 x 244 x 14 mm	
Work size	structured, matt	structured, matt	structured, matt	structured, matt	structured, matt	structured, matt
m - pieces	4.000	2.000	2.000	2.000	2.000	2.000
pce./pair - kg	0.500/pieces	2.500/pieces	2.300/pieces	3.800/pair	2.500/pieces	
Bundle - pce./pair	20 pieces	5 pieces	5 pieces	2 pairs	5 pieces	
Bundle - m		2.500	2.500			
Bundle - kg	10.000	12.500	11.500	7.600	12.500	
Pallet - m ²						
Pallet - kg						
Product standard	Alb	Alb	Alb	Alb	Alb	Alb
Slip resistance		R11/B	R11/B	R11/B	R11/B	R11/B
pearl	430806H Price gr. A423 (pce.)	430810H Price gr. A519 (pce.)	430814H Price gr. A593 (pce.)	430818H Price gr. A645 (pair)	430822H Price gr. A593 (pce.)	
mud	430807H Price gr. A423 (pce.)	430811H Price gr. A519 (pce.)	430815H Price gr. A593 (pce.)	430819H Price gr. A645 (pair)	430823H Price gr. A593 (pce.)	
stone	430808H Price gr. A423 (pce.)	430812H Price gr. A519 (pce.)	430816H Price gr. A593 (pce.)	430820H Price gr. A645 (pair)	430824H Price gr. A593 (pce.)	
graphite	430809H Price gr. A423 (pce.)	430813H Price gr. A519 (pce.)	430817H Price gr. A593 (pce.)	430821H Price gr. A645 (pair)	430825H Price gr. A593 (pce.)	
shell NEW	431557H Price gr. A423 (pce.)	431559H Price gr. A519 (pce.)	431561H Price gr. A593 (pce.)	431563H Price gr. A645 (pair)	431565H Price gr. A593 (pce.)	
sand NEW	431558H Price gr. A423 (pce.)	431560H Price gr. A519 (pce.)	431562H Price gr. A593 (pce.)	431564H Price gr. A645 (pair)	431566H Price gr. A593 (pce.)	



¹ rectified

² Also available in a length of 497 mm on request

³ Make-to-order production: return and/or cancellation of ordered products not possible.

⁴ The cove skirting, decorated complies with DIN EN 14411, group Al_b, glazed (GL)

⁵ Short edges rectified

All products: Color Shade Variation V3

Patio Tile – 3 mm joint^{1/2}

50 x 100 cm

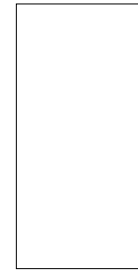

60 x 90 cm

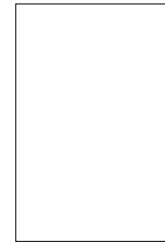

					50 x 100 / 20 x 40	60 x 90 / 24 x 36			Nom. dim. - cm/in
					497 x 997 x 20 mm	597 x 897 x 20 mm			Work size
					structured, matt	structured, matt			Surface
					2.000	1.852			m ² - pieces
					43.060	43.152			m ² - kg
					1	1			Bundle - pieces
					0.500	0.540			Bundle - m ²
					21.530	23.300			Bundle - kg
					22.500	11.345			Pallet - m ²
					968.850	489.300			Pallet - kg
					Alla	Alla			Product standard
					R11/B	R11/B			Slip resistance
					3	3			Stress group
					430826H	430830H	4		pearl
					Price gr. A293 (m ²)	Price gr. A281 (m ²)			
					430827H	430831H	4		mud
					Price gr. A293 (m ²)	Price gr. A281 (m ²)			
					430828H	430832H	4		stone
					Price gr. A293 (m ²)	Price gr. A281 (m ²)			
					430829H	430833H	4		graphite
					Price gr. A293 (m ²)	Price gr. A281 (m ²)			
					431567H	431568H			
					Price gr. A293 (m ²)	Price gr. A281 (m ²)	4		sand

¹  rectified

² High weight only to carry with two persons.

All products: Color Shade Variation V3



NEW



3D-Rendering / Series: Basic Stone





Modern and durable

Inspired by slate structures, Basic Stone was created. The ceramic surface of the 5 x 5 cm mosaic made of unglazed porcelain stoneware with Hytect surface represents the theme of slate in a modern and at the same time durable manner through a relief mix in combination with discreet graphics. Fine glossy spots of mica and subtle color contrasts underline the stony character of the surface. The color range is based on natural slate colors.

Mosaic, 5 x 5 cm, 2 x 2 in



Mosaic sheet 30 x 30 cm, 12 x 12 in, black, structured, R10/B

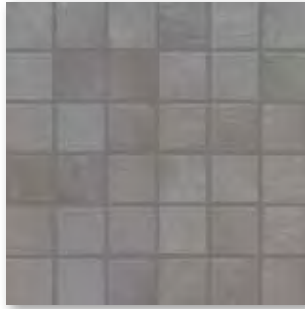

Mosaic sheet 30 x 30 cm, 12 x 12 in, medium grey, structured, R10/B



Mosaic sheet 30 x 30 cm, 12 x 12 in, light grey, structured, R10/B

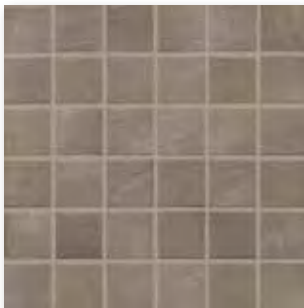

Mosaic sheet 30 x 30 cm, 12 x 12 in, mud, structured, R10/B



Mosaic sheet 30 x 30 cm, 12 x 12 in, beige, structured, R10/B

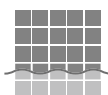

Mosaics glued thermoplastically on back of AGROB BUCHTAL can be used not only in dry zones but also without any problems in underwater areas (e.g. swimming pools/whirlpools) as well as in permanently wet areas (e.g. pool surrounds/showers).

Mosaic

5 x 5 cm

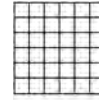

Mosaic, glued
thermoplastically
on back
Sheet: 297 x 297 mm



					5 x 5 / 2 x 2	Nom. dim. - cm/in
					47 x 47 x 6.5 mm	Work size
					structured, matt	Surface
					11 sheets	m ² - pieces
					12.331	m ² - kg
					11 sheets	Bundle - pieces
					1.000	Bundle - m ²
					12.331	Bundle - kg
					64.000	Pallet - m ²
					789.184	Pallet - kg
					Bla	Product standard
					R10/B	Slip resistance
					1 - 2	Stress group
					42200H-73	
					Price gr. A211 (m ²)	black
					42201H-73	
					Price gr. A211 (m ²)	medium grey
					42202H-73	
					Price gr. A211 (m ²)	light-grey
					42203H-73	
					Price gr. A211 (m ²)	mud
					42204H-73	
					Price gr. A211 (m ²)	beige

Color Shade Variation: V2

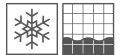





Timeless and simple

The timeless color range and formats from 5 x 5 cm up to 35 x 100 cm permit economical solutions in diverse areas. Basis Pro, the new additional series, enlarges the range with a selection of porcelain stoneware floor tiles in a contemporary and long-lasting design. Further advantages: the high slip resistances from R10/A to R11/B and up to R13V10, shower tub systems, stair tiles and special pieces complete the range.



Basis 1

Earthenware, glazed

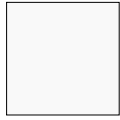

white, glossy



white, matt



white, matt and glossy, undulated



white, glossy, hammered



white, marbled, glossy and matt



pale grey, marbled, glossy and matt



beige, marbled, glossy and matt



sand-beige, glossy and matt

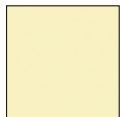

ivory, glossy

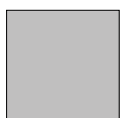

light-grey, matt



light-beige, matt



Listel Candy, 4.5 x 20 cm, 1 13/16 x 8 in



Listel Candy, 1 x 20 cm, 3/8 x 8 in

Basis 1+

Earthenware, glazed



white, glossy



white, matt



white, glossy, undulated



white, matt, undulated

Basis 2

Earthenware, glazed

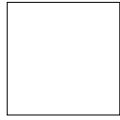

white, matt



white, glossy



grey, matt



light-grey, matt

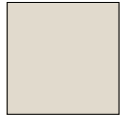

light-beige, matt

Basis 3

Porcelain stoneware, unglazed



titanit



anthracite



mid-grey



chalk



smooth R10/A and R10/B



Softcorn 2 R11/B

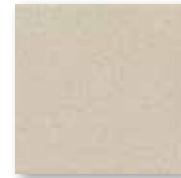

Perlstic R12



Opticorn R12V4



Picstic R12V8



Roughened R13



Kombicorn R13V10

Basis 4

Stoneware tiles, glazed



white, glossy



white, matt



grey transparent, matt



light-grey, matt



light-sahara, matt



soft azure, glossy



light-blue, glossy



azure dark, glossy

Wall Tiles

15 x 15 cm



15 x 15 cm



15 x 30 cm



20 x 20 cm



20 x 25 cm



20 x 40 cm



20 x 60 cm



15 x 15 / 6 x 6	15 x 15 / 6 x 6	15 x 30 cm / 6 x 12	20 x 20 / 8 x 8	20 x 25 / 8 x 10	20 x 40 / 8 x 16	20 x 60 / 8 x 24	Nom. dim. - cm/in
150 x 150 x 5.0 mm	147 x 147 x 5.0 mm	147 x 297 x 6.5 mm	197 x 197 x 6.0 mm	198 x 248 x 6.0 mm	197 x 397 x 7.5 mm	197 x 597 x 9.0 mm	Work size
smooth	smooth	smooth	smooth	smooth	smooth	smooth	Surface
44.000	44.000	22.222	25.000	20.000	12.500	8.333	m ² - pieces
9.504	9.416	10.622	10.800	10.260	12.975	15.516	m ² - kg
44	44	24	25	20	16	8	Bundle - pieces
1.000	1.000	1.080	1.000	1.000	1.280	0.960	Bundle - m ²
9.504	9.416	11.472	10.800	10.260	16.608	14.896	Bundle - kg
105.000	105.000	91.801	96.000	92.000	92.160	61.442	Pallet - m ²
997.920	988.680	975.120	1,036.800	943.920	1.195.776	953.344	Pallet - kg
BIII	BIII	BIII	BIII	BIII	BIII	BIII	Product standard
112000	531910-148	173368	532230-800	538020-400	182763	381474	
Price gr. A55 (m ²)	Price gr. A46 (m ²)	Price gr. A58 (m ²)	Price gr. A46 (m ²)	Price gr. A46 (m ²)	Price gr. A85 (m ²)	Price gr. A85 (m ²)	white, glossy
115100	531911-148	173369	532212-800	538021-400	182764	381475	
Price gr. A55 (m ²)	Price gr. A46 (m ²)	Price gr. A58 (m ²)	Price gr. A46 (m ²)	Price gr. A46 (m ²)	Price gr. A85 (m ²)	Price gr. A85 (m ²)	white, matt
113063							white, glossy, hammered
Price gr. A112 (m ²)							ivory, glossy
111052							light-grey, marbled, glossy
Price gr. A112 (m ²)				538260-400			Price gr. A46 (m ²)
				538261-400			Price gr. A46 (m ²)
				Price gr. A46 (m ²)			light-grey, marbled, matt
				538280-400			beige, marbled, glossy
				Price gr. A46 (m ²)			beige, marbled, matt
				538281-400			Price gr. A46 (m ²)
				Price gr. A46 (m ²)			light-grey, matt
		173339	213341		183343		Price gr. A100 (m ²)
		Price gr. A64 (m ²)	Price gr. A58 (m ²)		Price gr. A100 (m ²)		light-beige, matt
		173340	213342		183344		Price gr. A100 (m ²)
		Price gr. A64 (m ²)	Price gr. A58 (m ²)		Price gr. A100 (m ²)		light-beige, matt

Color Shade Variation:

V0: ivory, glossy, light-grey, matt, light-beige, matt, white, glossy, white, matt, white, glossy, hammered

V3: light-beige, marbled, glossy, beige, marbled

Wall Tiles

25 x 33 cm



30 x 60 cm



30 x 60 cm



30 x 60 cm¹



30 x 90 cm²



30 x 90 cm²



35 x 100 cm²



Nom. dim. - cm/in	25 x 33 / 10 x 13	30 x 60 / 12 x 24	30 x 60 / 12 x 24	30 x 60 / 12 x 24	30 x 90 / 12 x 36	30 x 90 / 12 x 36	35 x 100 / 14 x 40
Work size	249 x 330 x 8.0 mm	297 x 597 x 9.0 mm	297 x 597 x 6.0 mm	297 x 597 x 9.0 mm	297 x 897 x 6.0 mm	297 x 897 x 10.5 mm	347 x 997 x 6 mm
Surface	smooth	smooth	smooth	smooth	smooth	smooth	smooth
m ² - pieces	12.121	5.556	5.556	5.556	3.704	3.704	2.857
m ² - kg	12.969	14.946	10.279	15.279	10.400	17.976	10.108
Bundle - pieces	13	9	13	9	8	5	5
Bundle - m ²	1.073	1.620	2.339	1.620	2.160	1.350	1.750
Bundle - kg	13.910	24.210	24.050	24.750	22.464	24.265	17.690
Pallet - m ²	80.439	77.754	112.311	77.754	51.836	32.397	70.000
Pallet - kg	1,043.250	1,162.080	1,154.444	1,188.000	539.094	582.360	707.600
Product standard	BIII	BIII	BIII	BIII	BIII	BIII	BIII
	239996	280374	203264	282115R-02	323260	391589	363335
white, glossy	Price gr. A49 (m ²)	Price gr. A91 (m ²)	Price gr. A52 (m ²)	Price gr. A109 (m ²)	Price gr. A148 (m ²)	Price gr. A166 (m ²)	Price gr. A154 (m ²)
	239995	280375	203265	282116R-02	323261	391590	363336
white, matt	Price gr. A49 (m ²)	Price gr. A91 (m ²)	Price gr. A52 (m ²)	Price gr. A109 (m ²)	Price gr. A148 (m ²)	Price gr. A166 (m ²)	Price gr. A154 (m ²)
white, glossy, undulated	239998	280718					
	Price gr. A55 (m ²)	Price gr. A100 (m ²)					
white, matt, undulated	239997	280719					
	Price gr. A55 (m ²)	Price gr. A100 (m ²)					
white, marbled, glossy			203444				
			Price gr. A58 (m ²)				
white, marbled, matt			203445				
			Price gr. A58 (m ²)				
sand-beige, glossy		280871					
		Price gr. A100 (m ²)					
sand-beige, matt		280872					
		Price gr. A100 (m ²)					
light-grey, matt		283345					
		Price gr. A100 (m ²)					
light-beige, matt		283346					
		Price gr. A100 (m ²)					
light-grey, marbled, glossy	231032						
	Price gr. A49 (m ²)						
light-grey, marbled, matt	231034						
	Price gr. A49 (m ²)						



¹ Edges sanded

Color Shade Variation:

V0: light-grey, matt, sand-beige, glossy, sand-beige, matt, white, glossy, white, matt, white, glossy, undulated, white, matt, undulated

V3: light-grey, marbled, glossy, light-grey, marbled, matt, white, marbled, glossy, white, marbled, matt

Listel

1 x 20 cm



4.5 x 20 cm



Nom. dim. - cm/in	1 x 20 / 3/8 x 8	4.5 x 20 / 1 13/16 x 8				
Work size	10 x 197 x 6.0 mm	45 x 197 x 6.0 mm				
Surface	smooth, silky-matt	smooth, silky-matt				
m ² /m - pieces	5.000/m	5.000/m				
m ² /m - kg	0.125/m	0.505/m				
Bundle - pieces	100	72				
Bundle - m	20.000	14.400				
Bundle - kg	2.500	7.272				
Pallet - m ²						
Pallet - kg						
Product standard	BIII	BIII				
	533436-198	533434-198				
candy	Price gr. A423 (pce.)	Price gr. A445 (pce.)				

Color Shade Variation: V0

Wall Tiles

20 x 60 cm



30 x 60 cm



30 x 60 cm²



30 x 60 cm

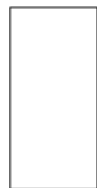

30 x 90 cm¹



30 x 90 cm²



35 x 100²



20 x 60 / 8 x 24	30 x 60 / 12 x 24	30 x 60 / 12 x 24	30 x 60 / 12 x 24	30 x 90 / 12 x 36	30 x 90 / 12 x 36	35 x 100 / 14 x 40	Nom. dim. - cm/in
197 x 597 x 9.0 mm	297 x 597 x 9.0 mm	297 x 597 x 9.0 mm	297 x 597 x 6.0 mm	297 x 897 x 10.5 mm	297 x 897 x 6 mm	347 x 997 x 6 mm	Work size
smooth	smooth	smooth	smooth	smooth	smooth	smooth	Surface
8.333	5.556	5.556	5.556	3.704	3.704	2.857	m ² - pieces
15.516	14.946	15.279	10.279	17.976	10.400	10.108	m ² - kg
8	9	9	13	5	8	5	Bundle - pieces
0.960	1.620	1.620	2.339	1.350	2.160	1.750	Bundle - m ²
14.896	24.210	24.750	24.050	24.265	22.464	17.690	Bundle - kg
61.442	77.754	77.754	112.311	32.397	51.836	70.000	Pallet - m ²
953.344	1,162.080	1,188.000	1,154.444	582.360	539.094	707.600	Pallet - kg
BIII	BIII	BIII	BIII	BIII	BIII	BIII	Product standard
381467	289358	282887R	203266H	391572	323262H	363337H	
Price gr. A100 (m ²)	Price gr. A109 (m ²)	Price gr. A124 (m ²)	Price gr. A70 (m ²)	Price gr. A175 (m ²)	Price gr. A157 (m ²)	Price gr. A163 (m ²)	white, glossy
381468	289359	282888R	203267H	391573	323263H	363338H	
Price gr. A100 (m ²)	Price gr. A109 (m ²)	Price gr. A124 (m ²)	Price gr. A70 (m ²)	Price gr. A175 (m ²)	Price gr. A157 (m ²)	Price gr. A163 (m ²)	white, matt
	289360						white, glossy,
	Price gr. A118 (m ²)						undulated
	289361						white, matt,
	Price gr. A118 (m ²)						undulated

¹ Edges sanded



All products: Color Shade Variation V0

Wall/Floor Tiles

Cove skirting

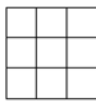
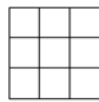
10 x 10 cm¹10 x 10 cm¹

15 x 15 cm

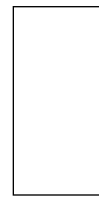

20 x 20 cm

30 x 60 cm³10 x 10 cm²

Mosaic, glued
thermoplastically
on back
Sheet: 297 x 297 mm

Mosaic, glued
thermoplastically
on back
Sheet: 297 x 297 mm

Nom. dim. - cm/in	10 x 10 / 4 x 4	10 x 10 / 4 x 4	15 x 15 / 6 x 6	20 x 20 / 8 x 8	30 x 60 / 12 x 24	10 x 10 / 4 x 4	
Work size	97 x 97 x 6.5 mm	97 x 97 x 6.5 mm	147 x 147 x 6.5 mm	197 x 197 x 6.5 mm	297 x 597 x 8.0 mm	100 x 97 x 6.0 mm	
Surface	smooth, matt	smooth, matt	smooth, matt	smooth, matt	smooth	smooth, matt	
m ² /m - pieces	11 sheets/m ²	11 sheets/m ²	44.000/m ²	25.000/m ²	5.556/m ²	10.000/m	
m ² /m - kg	13.101/m ²	13.101/m ²	13.816/m ²	13.875/m ²	17.413/m ²	1.500/m	
Bundle - pieces	11 sheets	11 sheets	44	25	6	40	
Bundle - m ² /m	1.000 m ²	1.000 m ²	1.000 m ²	1.000 m ²	1.080 m ²	6.000 m	
Bundle - kg	13.101	13.101	13.816	13.875	18.804	5.600	
Pallet - m ²	64.000	64.000	80.000	72.000	43.197		
Pallet - kg	838.464	838.464	1,105.280	999.000	752.242		
Product standard	BIb	BIb	BIb	BIb	AIb	BIb	
Slip resistance		R10/B				R10/B	
Stress group	1 - 2	1 - 2	1 - 2	1 - 2	1 - 2		
	4	4	4	4	4	4	
white, matt	620811-504 Price gr. A127 (m ²)	600859-504 Price gr. A154 (m ²)	620805-504 Price gr. A112 (m ²)	620806-504 Price gr. A100 (m ²)	430964 Price gr. A160 (m ²)	600864-504 Price gr. A414 (pce.)	
white, glossy					430963 Price gr. A160 (m ²)		
grey	620811-505 Price gr. A127 (m ²)	600859-505 Price gr. A154 (m ²)	620805-505 Price gr. A112 (m ²)	620806-505 Price gr. A100 (m ²)		600864-505 Price gr. A414 (pce.)	
light-grey, matt				430967 Price gr. A142(m ²)	430965 Price gr. A169 (m ²)		
light-beige, matt				430968 Price gr. A142 (m ²)	430966 Price gr. A169 (m ²)		



² For details, refer to page 716



³ rectified

All products: Color Shade Variation V0

Wall/Floor Tiles

5 x 5 cm¹

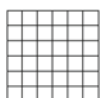

Mosaic, glued
thermoplastically
on back
Sheet: 297 x 297 mm

10 x 10 cm¹



Mosaic, glued
thermoplastically
on back
Sheet: 297 x 297 mm

15 x 15 cm



Micro

15 x 15 cm



Softcorn 2

20 x 20 cm



Micro

20 x 20 cm



Softcorn 2

20 x 20 cm



Perlstic



protected

5 x 5 / 2 x 2	10 x 10 / 4 x 4	15 x 15 / 6 x 6	15 x 15 / 6 x 6	20 x 20 / 8 x 8	20 x 20 / 8 x 8	20 x 20 / 8 x 8	Nom. dim. - cm/in
47 x 47 x 6.5 mm	97 x 97 x 6.5 mm	147 x 147 x 10.5 mm	147 x 147 x 10.5 mm	197 x 197 x 9.0 mm	197 x 197 x 9.0 mm	197 x 197 x 9.0 mm	Work size
smooth, matt	smooth, matt	smooth, matt	structured, matt	smooth, matt	structured, matt	fine-grained, matt	Surface
11 sheets	11 sheets	44.444	44.444	25.000	25.000	25.000	m ² - pieces
12.331	13.101	23.111	23.111	19.450	19.450	19.450	m ² - kg
11 sheets	11 sheets	27	27	25	25	25	Bundle - pieces
1.000	1.000	0.608	0.608	1.000	1.000	1.000	Bundle - m ²
12.331	13.101	14.040	14.040	19.450	19.450	19.450	Bundle - kg
64.000	64.000	48.600	48.600	60.000	60.000	60.000	Pallet - m ²
789.184	838.464	1,123.200	1,123.200	1,167.000	1,167.000	1,167.000	Pallet - kg
Bla	Bla	Bla	Bla	Bla	Bla	Bla	Product standard
R10/B	R10/B	R10/A	R11/B	R10/A	R11/B	R12	Slip resistance
1 - 2	1 - 2	2 - 3	2 - 3	2 - 3	2 - 3	2 - 3	Stress group
620510-070	620460-070	601500-070-71	601550-070-71	620249-070	620450-070	620470-070	titanit
Price gr. A193 (m ²)	Price gr. A160 (m ²)	Price gr. A118 (m ²)	Price gr. A133 (m ²)	Price gr. A94 (m ²)	Price gr. A112 (m ²)	Price gr. A112 (m ²)	
620510-072	620460-072	601500-072-71	601550-072-71	620249-072	620450-072	620470-072	anthracite
Price gr. A193 (m ²)	Price gr. A160 (m ²)	Price gr. A118 (m ²)	Price gr. A133 (m ²)	Price gr. A94 (m ²)	Price gr. A112 (m ²)	Price gr. A112 (m ²)	
620510-073	620460-073			620249-073	620450-073	620470-073	mid-grey
Price gr. A193 (m ²)	Price gr. A160 (m ²)			Price gr. A94 (m ²)	Price gr. A112 (m ²)	Price gr. A112 (m ²)	
620510-075	620460-075	601500-075-71	601550-075-71	620249-075	620450-075	620470-075	chalk
Price gr. A193 (m ²)	Price gr. A160 (m ²)	Price gr. A118 (m ²)	Price gr. A133 (m ²)	Price gr. A94 (m ²)	Price gr. A112 (m ²)	Price gr. A112 (m ²)	



All products: Color Shade Variation V1



Wall/Floor Tiles

20 x 20 cm



20 x 20 cm¹



20 x 20 cm



20 x 20 cm



30 x 30 cm



30 x 30 cm



protected

Opticorn	Picstic	Roughened	Kombicorn	Micro	Softcorn 2	Nom. dim. - cm/in
20 x 20 / 8 x 8	20 x 20 / 8 x 8	20 x 20 / 8 x 8	20 x 20 / 8 x 8	30 x 30 / 12 x 12	30 x 30 / 12 x 12	Work size
197 x 197 x 9.0 mm	197 x 197 x 9.0 mm	197 x 197 x 9.0 mm	197 x 197 x 9.0 mm	297 x 297 x 9.0 mm	297 x 297 x 9.0 mm	Surface
grained, matt	grained, matt	profiled, matt	profiled, matt	structured, matt	structured, matt	m ² - pieces
25.000	25.000	25.000	25.000	11.111	11.111	m ² - kg
19.450	19.450	19.450	19.450	19.478	19.478	Bundle - pieces
25	25	25	25	13	13	Bundle - m ²
1.000	1.000	1.000	1.000	1.170	1.170	Bundle - kg
19.450	19.450	19.450	19.450	22.789	22.789	Pallet - m ²
60.000	60.000	60.000	60.000	56.161	56.161	Pallet - kg
1,167.000	1,167.000	1,167.000	1,167.000	1,093.884	1,093.884	Product standard
Bla	Bla	Bla	Bla	Bla	Bla	Slip resistance
R12V4	R12V8	R13	R13V10	R10	R11/B	Stress group
2 - 3	2 - 3	2 - 3	2 - 3	2 - 3	2 - 3	
620290-070	620296-070			620241-070		titanit
Price gr. A112 (m ²)	Price gr. A148 (m ²)			Price gr. A76 (m ²)		
620290-072	620296-072	620480-072	620490-072	620241-072	620245-072	anthracite
Price gr. A112 (m ²)	Price gr. A148 (m ²)	Price gr. A157 (m ²)	Price gr. A157 (m ²)	Price gr. A76 (m ²)	Price gr. A109 (m ²)	
620290-073				620241-073		mid-grey
Price gr. A112 (m ²)				Price gr. A76 (m ²)		
620290-075	620296-075	620480-075	620490-075	620241-075		chalk
Price gr. A112 (m ²)	Price gr. A148 (m ²)	Price gr. A157 (m ²)	Price gr. A157 (m ²)	Price gr. A76 (m ²)		

¹ On request, also available in a thickness of 10,5 mm

All products: Color Shade Variation V1

Wall/
Floor Tiles30 x 60 cm¹

Skirting, cut

7 x 20 cm



7 x 30 cm



Stair Tiles

30 x 30 cm²

protected

	Micro	Micro	Micro	Micro			
Nom. dim. - cm/in	30 x 60 / 12 x 24	7 x 20 / 2 13/16 x 8	7 x 30 / 2 13/16 x 12	30 x 30 / 12 x 12			
Work size	297 x 597 x 10.5 mm	70 x 197 x 9.0 mm	70 x 297 x 9.0 mm	297 x 297 x 9.0 mm			
Surface	smooth, matt	smooth, matt	smooth, matt	smooth, matt			
m ² /m - pieces	5.556/m ²	5.000/m	3.333/m	3.333/m			
m ² /m - kg	23.224/m ²	1.400/m	1.399/m	5.906/m			
Bundle - pieces	6	60	50	11			
Bundle - m ² /m	1.080 m ²	12.000 m	15.001 m	3.300 m			
Bundle - kg	25.080	16.800	21.000	19.492			
Pallet - m ²	43.197						
Pallet - kg	1,003.200						
Product standard	Bla	Bla	Bla	Bla			
Slip resistance	R10			R10			
Stress group	2 - 3			2 - 3			
titanit	623060-070 Price gr. A139 (m ²)	600334-070 Price gr. A410 (pce.)	600384-070 Price gr. A411 (pce.)	600499-070 Price gr. A428 (pce.)			
anthracite	623060-072 Price gr. A139 (m ²)	600334-072 Price gr. A410 (pce.)	600384-072 Price gr. A411 (pce.)	600499-072 Price gr. A428 (pce.)			
medium grey	623060-073 Price gr. A139 (m ²)	600334-073 Price gr. A410 (pce.)	600384-073 Price gr. A411 (pce.)	600499-073 Price gr. A428 (pce.)			
chalk	623060-075 Price gr. A139 (m ²)	600334-075 Price gr. A410 (pce.)	600384-075 Price gr. A411 (pce.)	600499-075 Price gr. A428 (pce.)			



1 rectified



2 Make-to-order production: return and/or cancellation of ordered products not possible.

All products: Color Shade Variation V1

Cove skirting

10 x 10 cm¹10 x 15 cm¹10 x 20 cm¹Internal
Corner
for Cove
Skirting^{1/2}External
Corner
for Cove
Skirting^{1/2}

Shower Tub System

10 x 10 cm³10 x 10 cm³

protected

						Softcorn Strip	Softcorn Ecke
Nom. dim. - cm/in	10 x 10 / 4 x 4	10 x 15 / 4 x 6	10 x 20 / 4 x 8	102 x 20 x 9.0 mm	102 x 35 x 9.0 mm	10 x 10 / 4 x 4	10 x 10 / 4 x 4
Work size	100 x 97 x 6.0 mm	102 x 147 x 9 mm	102 x 197 x 9.0 mm	smooth, matt	smooth, matt	97 x 97 x 9 mm	97 x 97 x 9 mm
Surface	smooth, matt	smooth, matt	smooth, matt			grained, matt	grained, matt
m - pieces	10.000	6.667	5.000	0.080/pieces	0.080/pieces	10.000	0.202/pieces
m/pce. - kg	1.500/m	2.000/m	2.000/m	18	12	2.020/m	0.600
Bundle - pieces	40	24	20	1.440	0.960	6	1.212
Bundle - m	4.000	3.600	4.000			0.600	0.808
Bundle - kg	6.000	7.200	8.000			1.212	0.808
Pallet - m							
Pallet - kg							
Product standard	Bla	Bla	Bla	Bla	Bla	Bla	Bla
Slip resistance	R10/B	R10/A	R10/A			R11/B	R11/B
titanit	600450-070 Price gr. A410 (pce.)	600430-070-71 Price gr. A414 (pce.)	600420-070 Price gr. A414 (pce.)	600416-070 Price gr. A418 (pce.)	600417-070 Price gr. A418 (pce.)	600442-070 Price gr. A428 (pce.)	600443-070 Price gr. A458 (pce.)
anthracite	600450-072 Price gr. A410 (pce.)	600430-072-71 Price gr. A414 (pce.)	600420-072 Price gr. A414 (pce.)	600416-072 Price gr. A418 (pce.)	600417-072 Price gr. A418 (pce.)	600442-072 Price gr. A428 (pce.)	600443-072 Price gr. A458 (pce.)
medium grey	600450-073 Price gr. A410 (pce.)		600420-073 Price gr. A414 (pce.)	600416-073 Price gr. A418 (pce.)	600417-073 Price gr. A418 (pce.)	600442-073 Price gr. A428 (pce.)	600443-073 Price gr. A458 (pce.)
chalk	600450-075 Price gr. A410 (pce.)	600430-075-71 Price gr. A414 (pce.)	600420-075 Price gr. A414 (pce.)	600416-075 Price gr. A418 (pce.)	600417-075 Price gr. A418 (pce.)	600442-075 Price gr. A428 (pce.)	600443-075 Price gr. A458 (pce.)



1 For details, refer to page 716

2 Fitting to cove skirting 10 x 15 cm and 10 x 20 cm.

3 For details, refer to page 714

All products: Color Shade Variation V1

Wall/Floor Tiles

25 x 12.5 cm



25 x 12.5 cm



25 x 12.5 cm



(8 mm thick)

(6 mm thick)

(8 mm thick)

				38110	18120	8110		Model number
				25 x 12.5 / 10 x 5	25 x 12.5 / 10 x 5	25 x 12.5 / 10 x 5		Nom. dim. - cm/in
				244 x 119 x 8 mm	244 x 119 x 6 mm	240 x 115 x 8 mm		Work size
				smooth	smooth	smooth		Surface
				32.000	32.000	33.000		m ² - pieces
				15.680	12.160	15.180		m ² - kg
				33	44	33		Bundle - pieces
				1.031	1.375	1.000		Bundle - m ²
				16.170	16.720	15.180		Bundle - m ²
				86.625	115.500	84.000		Pallet - m ²
				1,358.280	1,404.480	1,275.120		Pallet - kg
				Alb	Alb	Alb		Product standard
				700-38110	700-18120	75917-8110	3	white, glossy
				Price gr. A112 (m ²)	Price gr. A112 (m ²)	Price gr. A88 (m ²)		
				701-38110	701-18120	75918-8110	4	white, matt
				Price gr. A112 (m ²)	Price gr. A112 (m ²)	Price gr. A88 (m ²)		
					509-18120		4	grey
					Price gr. A145 (m ²)			transparent matt
					711-18120		4	light-grey, matt
					Price gr. A145 (m ²)			
				703-38110	703-18120		4	light-sahara, matt
				Price gr. A145 (m ²)	Price gr. A145 (m ²)			
					732-18120		3	soft azure, glossy
					Price gr. A145 (m ²)			
						71152-8110	3	light-blue, glossy
						Price gr. A145 (m ²)		
					563-18120		1	azure dark, glossy
					Price gr. A145 (m ²)			

All products: Color Shade Variation V0





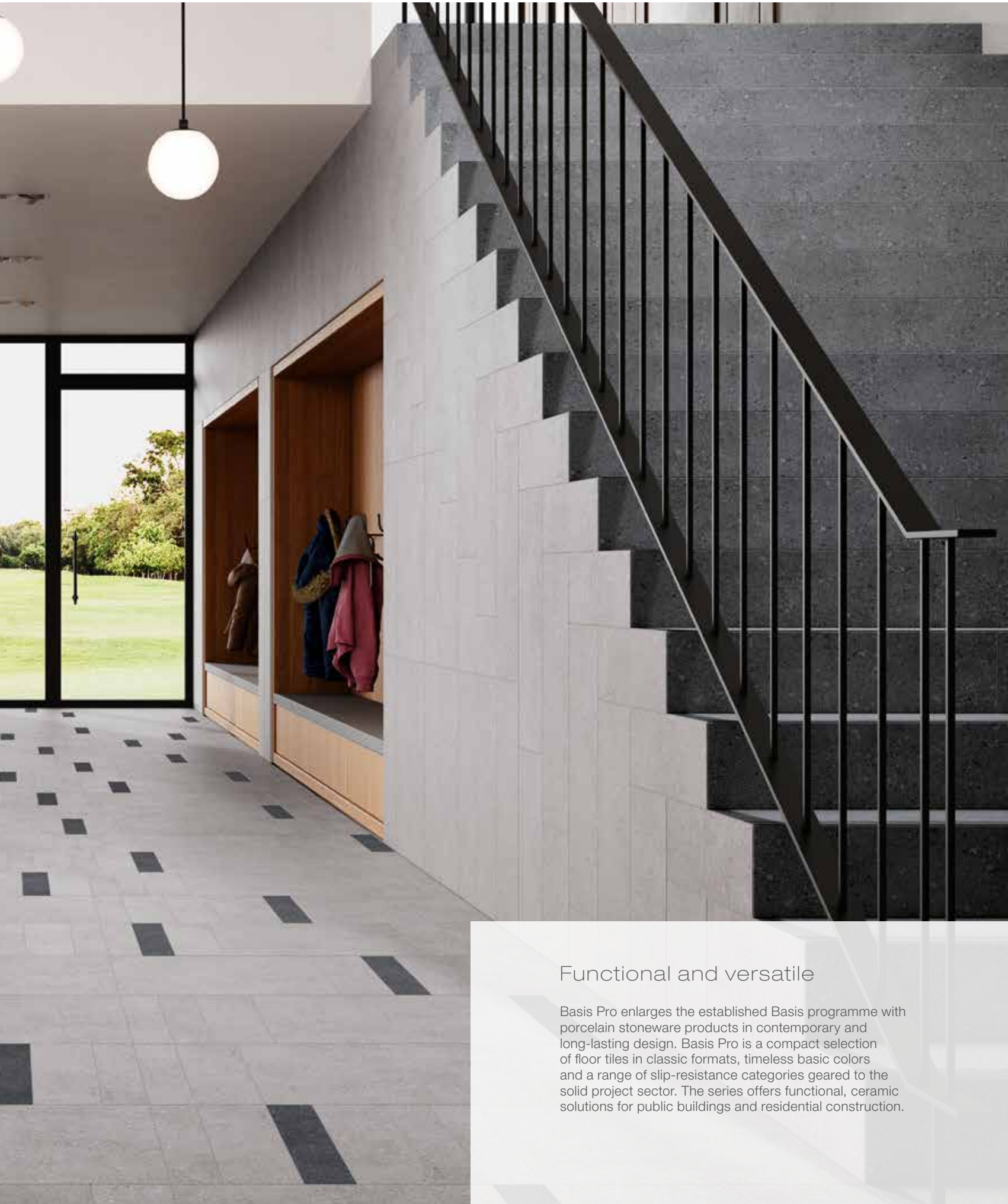

Functional and versatile

Basis Pro enlarges the established Basis programme with porcelain stoneware products in contemporary and long-lasting design. Basis Pro is a compact selection of floor tiles in classic formats, timeless basic colors and a range of slip-resistance categories geared to the solid project sector. The series offers functional, ceramic solutions for public buildings and residential construction.



sand-beige



ash-brown



concrete-grey



basalt



anthracite

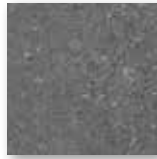

Floor tile 15 x 15 cm, 6 x 6 in, smooth, R10/B

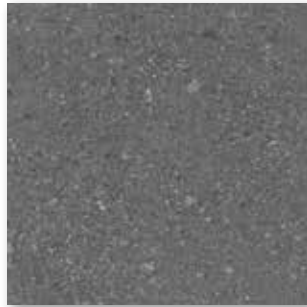

Floor tile 30 x 30 cm, 12 x 12 in, smooth, R10/A



Floor tile 10 x 60 cm, 4 x 24 in, smooth, R10/A

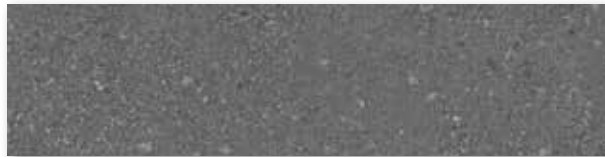

Floor tile 15 x 60 cm, 6 x 24 in, smooth, R10/A

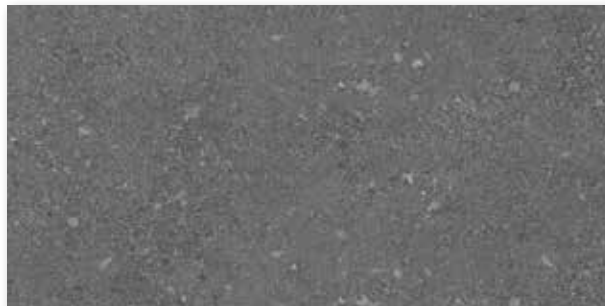

Floor tile 30 x 60 cm, 12 x 24 in, smooth, R10/A
 Floor tile 30 x 60 cm, 12 x 24 in, smooth, R11/B
 Floor tile 30 x 60 cm, 12 x 24 in, smooth, R12/C

Mosaic 5 x 5 cm, 2 x 2 in

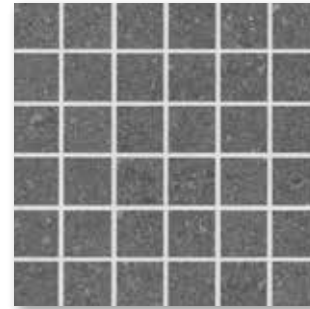

Mosaic sheet 30 x 30 cm, 12 x 12 in, smooth, R10/B

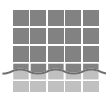

Mosaics glued thermoplastically on back of AGROB BUCHTAL can be used not only in dry zones but also without any problems in underwater areas (e.g. swimming pools/whirlpools) as well as in permanently wet areas (e.g. pool surrounds/showers).

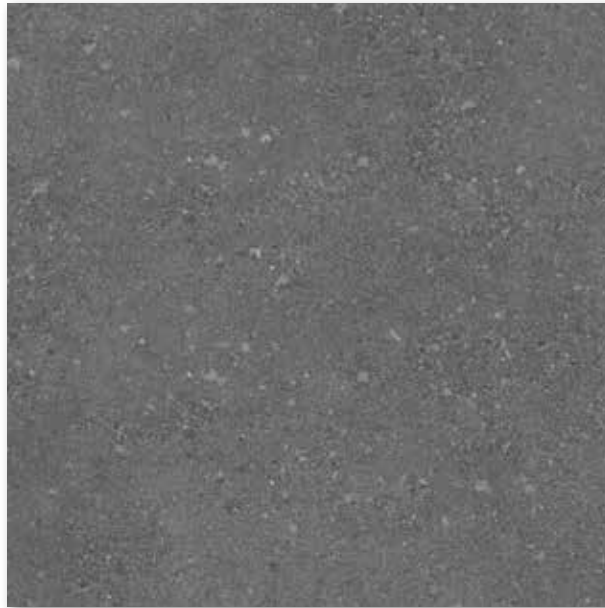

Floor tile 60 x 60 cm, 24 x 24 in, smooth, R10/A

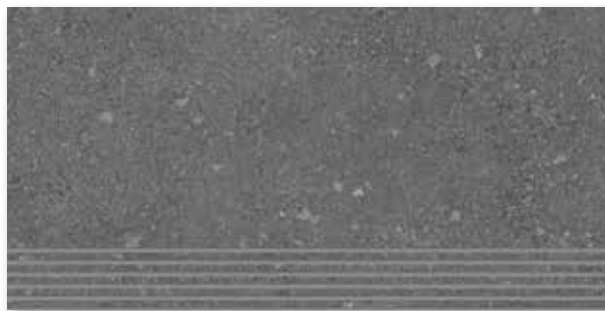

Stair tile, 30 x 60 cm, 12 x 24 in (with grooves), smooth, R10/A



Skirting, rounded 7 x 60 cm, 2 13/16 x 24 in, smooth



Cove skirting, decorated 10 x 30 cm, 4 x 12 in, smooth, R10/A

Mosaic

Floor Tiles

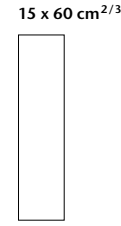
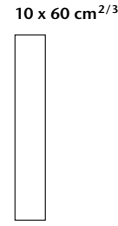
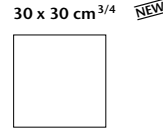
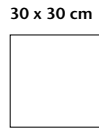
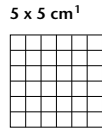

Mosaic, glued
thermoplastically
on back
Sheet: 297 x 297 mm

extra thick

Oblong format

Oblong format

Nom. dim. - cm/in	5 x 5 / 2 x 2	15 x 15 / 6 x 6	30 x 30 / 12 x 12	30 x 30 / 12 x 12	10 x 60 / 4 x 24	15 x 60 / 6 x 24	
Work size	47 x 47 x 6.5 mm	147 x 147 x 9 mm	297 x 297 x 9 mm	297 x 297 x 14 mm	97 x 597 x 9 mm	147 x 597 x 9 mm	
Surface	smooth, matt	smooth, matt	smooth, matt	smooth, matt	smooth, matt	smooth, matt	
m ² - pieces	11 sheets	44.444	11.111	11.337	16.667	11.111	
m ² - kg	12.331	19.822	19.478	32.027	20.283	19.900	
Bundle - pieces	11 sheets	32	13	7	17	13	
Bundle - m ²	1.000	0.720	1.170	0.617	1.020	1.170	
Bundle - kg	12.331	14.272	22.789	19.775	20.284	23.283	
Pallet - m ²	64.000	57.601	56.161	29.637	40.799	46.800	
Pallet - kg	789.184	1,141.760	1,093.880	949.200	827.560	931.311	
Product standard	Bla	Bla	Bla	Bla	Bla	Bla	
Slip resistance	R10/B	R10/B	R10/A	R10	R10/A	R10/A	
Stress group	1 - 2	2	2	3-4	2	2	
sand-beige	430901 Price gr. A205 (m ²)	430906 Price gr. A133 (m ²)	430911 Price gr. A88 (m ²)		430916 Price gr. A181 (m ²)	430921 Price gr. A181 (m ²)	
ash-brown	430902 Price gr. A205 (m ²)	430907 Price gr. A133 (m ²)	430912 Price gr. A88 (m ²)		430917 Price gr. A181 (m ²)	430922 Price gr. A181 (m ²)	
concrete-grey	430903 Price gr. A205 (m ²)	430908 Price gr. A133 (m ²)	430913 Price gr. A88 (m ²)	430993	430918 Price gr. A181 (m ²)	430923 Price gr. A181 (m ²)	
basalt	430904 Price gr. A205 (m ²)	430909 Price gr. A133 (m ²)	430914 Price gr. A88 (m ²)		430919 Price gr. A181 (m ²)	430924 Price gr. A181 (m ²)	
anthracite	430905 Price gr. A205 (m ²)	430910 Price gr. A133 (m ²)	430915 Price gr. A88 (m ²)	430992	430920 Price gr. A181 (m ²)	430925 Price gr. A181 (m ²)	



2 **rectified**



3 **Make-to-order production: return and/or cancellation of ordered products not possible.**



4 **Prices are calculated project-specifically**

All products: Color Shade Variation V2

Floor Tiles

30 x 60 cm¹



30 x 60 cm^{2/3/4} **NEW**



30 x 60 cm¹



30 x 60 cm¹

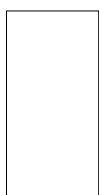

60 x 60 cm¹

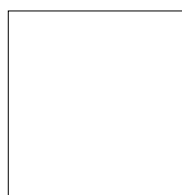

60 x 60 cm^{2/3/4} **NEW**



protected

	<i>extra thick</i>			<i>extra thick</i>			
	30 x 60 / 12 x 24	30 x 60 / 12 x 24	30 x 60 / 12 x 24	30 x 60 / 12 x 24	60 x 60 / 24 x 24	60 x 60 / 24 x 24	Nom. dim. - cm/in
	297 x 597 x 9 mm	297 x 597 x 14 mm	297 x 597 x 9 mm	297 x 597 x 9 mm	597 x 597 x 9 mm	600 x 600 x 14 mm	Work size
	smooth, matt	smooth, matt	smooth, matt	smooth, matt	smooth, matt	smooth, matt	Surface
	5.556	5.589	5.556	5.556	2.778	2.778	m ² - pieces
	19.907	32.159	19.907	19.907	20.371	31.669	m ² - kg
	7	4	7	7	3	2	Bundle - pieces
	1.260	0.716	1.260	1.260	1.080	0.720	Bundle - m ²
	25.081	23.016	25.081	25.081	21.999	22.800	Bundle - kg
	50.396	28.628	50.396	50.396	45.356	30.238	Pallet - m ²
	1,003.240	920.640	1,003.240	1,003.240	923.950	957.600	Pallet - kg
	Bla	Bla	Bla	Bla	Bla	Bla	Product standard
	R10/A	R10	R11/B	R12/C	R10/A	R10	Slip resistance
	2	3 - 4	2	2	2	3 - 4	Stress group
	430926	430997	430931	430936	430941	430979	sand-beige
	Price gr. A127 (m ²)		Price gr. A127 (m ²)	Price gr. A145 (m ²)	Price gr. A142 (m ²)		
	430927	430996	430932	430937	430942	430978	ash-brown
	Price gr. A127 (m ²)		Price gr. A127 (m ²)	Price gr. A145 (m ²)	Price gr. A142 (m ²)		
	430928	430995	430933	430938	430943	430977	concrete-grey
	Price gr. A127 (m ²)		Price gr. A127 (m ²)	Price gr. A145 (m ²)	Price gr. A142 (m ²)		
	430929		430934	430939	430944		basalt
	Price gr. A127 (m ²)		Price gr. A127 (m ²)	Price gr. A145 (m ²)	Price gr. A142 (m ²)		
	430930	430994	430935	430940	430945	430976	anthracite
	Price gr. A127 (m ²)		Price gr. A127 (m ²)	Price gr. A145 (m ²)	Price gr. A142 (m ²)		

¹ rectified

² Make-to-order production: return and/or cancellation of ordered products not possible.

³ conically rectified

⁴ Prices are calculated project-specifically

All products: Color Shade Variation V2



Cove skirting, decorated³ Stair Tiles^{1/2} Skirting, rounded¹



10 x 30 cm



30 x 60 cm

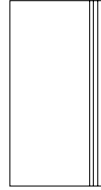

7 x 60 cm



Nom. dim. - cm/in	10 x 30 / 4 x 12	30 x 60 / 12 x 24	7 x 60 / 2 13/16 x 24				
Work size	102 x 297 x 9 mm	297 x 597 x 9 mm	70 x 597 x 9 mm				
Surface	smooth, matt	smooth, matt	smooth, matt				
m ² /m - pieces	3.333/m	1.667/m	1.667/m				
m ² /m - kg	1.999/m	5.973/m	1.357/m				
Bundle - pieces	16	7	15				
Bundle - m ² /m	4.800	4.199 m	8.998 m				
Bundle - kg	9.600	25.081	12.210				
Pallet - m ²							
Pallet - kg							
Product standard	Bla	Bla	Bla				
Slip resistance	R10/A	R10/A					
Stress group		2					
sand-beige	430946 Price gr. A423 (pce.)	430951 Price gr. A461 (pce.)	430956 Price gr. A441 (pce.)				
ash-brown	430947 Price gr. A423 (pce.)	430952 Price gr. A461 (pce.)	430957 Price gr. A441 (pce.)				
concrete-grey	430948 Price gr. A423 (pce.)	430953 Price gr. A461 (pce.)	430958 Price gr. A441 (pce.)				
basalt	430949 Price gr. A423 (pce.)	430954 Price gr. A461 (pce.)	430959 Price gr. A441 (pce.)				
anthracite	430950 Price gr. A423 (pce.)	430955 Price gr. A461 (pce.)	430960 Price gr. A441 (pce.)				



¹ rectified



² Make-to-order production: return and/or cancellation of ordered products not possible.

³ For details, refer to page 716

All products Color Shade Variation V2

Rendering: Series: Basis Pro



Project: Maximiliancenter at the central railway station / Location: Bonn, Germany / Architect: Forum Architecten & Planners BV / Series: Trias, Orientation Aids for the Blind / Photo: Jochen Stüber







Guide tile 30 x 30 cm, 12 x 12 in, ribbed structure, R11



Guide tile 30 x 30 cm, 12 x 12 in, knob structure, R11



Material ConneXion, NewYork, Bangkok, Milan, has awarded the Certificate of Excellence in Material Development to the orientation aids for the blind.



Guide tile 30 x 30 cm, 12 x 12 in, smooth, R11

Knob structure

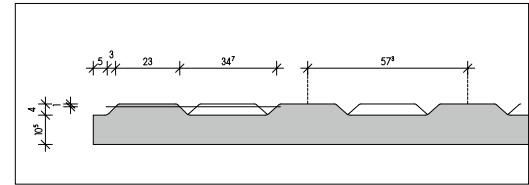
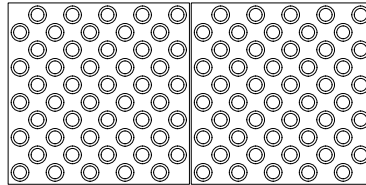

M.: 2:1

Ribbed structure

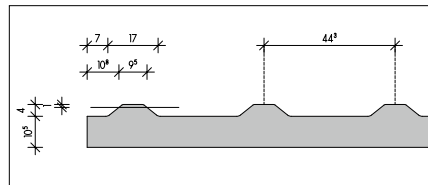
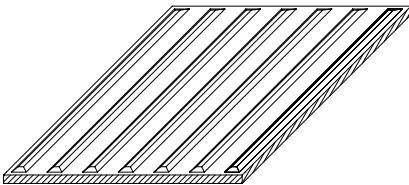

M.: 2:1

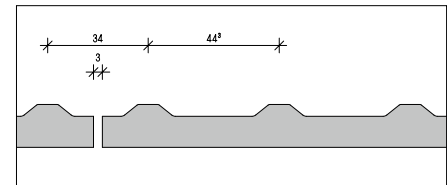

M.: 2:1

The system meets the requirements of DIN 32984.

The luminance contrast between color chalk and graphite is 0.7 and thus clearly surpasses the requirements.

Milled guide tile from any floor tiles on request.

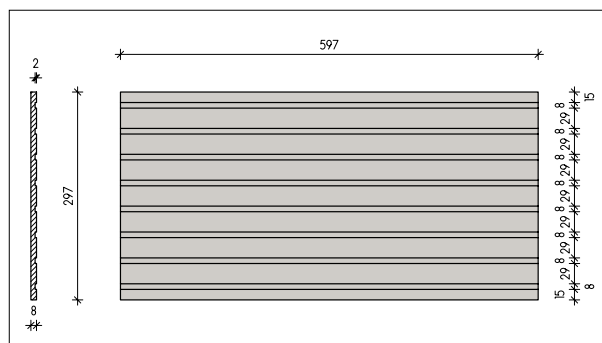

Guide Tiles

Floor Tile

30 x 30 cm

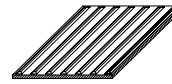

30 x 30 cm



30 x 30 cm



protected

				30 x 30 / 12 x 12	30 x 30 / 12 x 12	30 x 30 / 12 x 12	Nom. dim. - cm/in
				297 x 297 x 10.5 mm	297 x 297 x 10.5 mm	297 x 297 x 10.5 mm	Work size
				Ribbed structure	Knob structure	smooth, matt	Surface
				3.333/m	3.333/m	11.111/m ²	m/m ² - pieces
				7.999/m	7.999/m	23.144/m ²	m/m ² - kg
				8	8	11	Bundle - pieces
				2.400 m	2.400 m	0.990 m ²	Bundle - m/m ²
				19.200	19.200	22.913	Bundle - kg
						47.520	Pallet - m ²
						2,099.824	Pallet - kg
				Bla	Bla	Bla	Product standard
				R11	R11	R11	Slip resistance
				3	3	3	Stress group
				600356-103-70	600355-103-70	600357-103-70	chalk
				Price gr. A455 (pce.)	Price gr. A539 (pce.)	Price gr. A190 (m ²)	
				600356-106-70	600355-106-70	600357-106-70	graphite
				Price gr. A455 (pce.)	Price gr. A539 (pce.)	Price gr. A190 (m ²)	



Complying with the requirements of DIN 32984.

You will find further guide tiles for the blind in our Area Pro range.



All products: Color Shade Variation V0



Floor tile 15.4 x 15.4 cm, 6 3/16 x 6 3/16 in, ribbed structure, chalk, R11

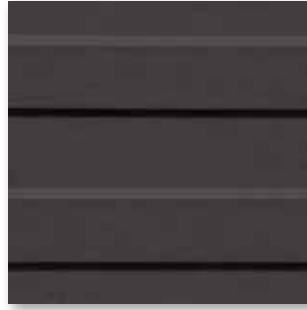

Floor tile 15.4 x 15.4 cm, 6 3/16 x 6 3/16 in, ribbed structure, anthracite R11

Guide tile: 6635

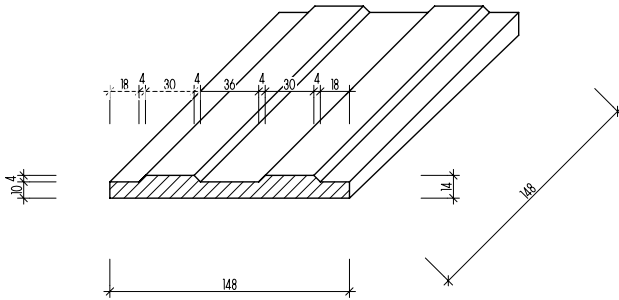

Guide tile: 6636

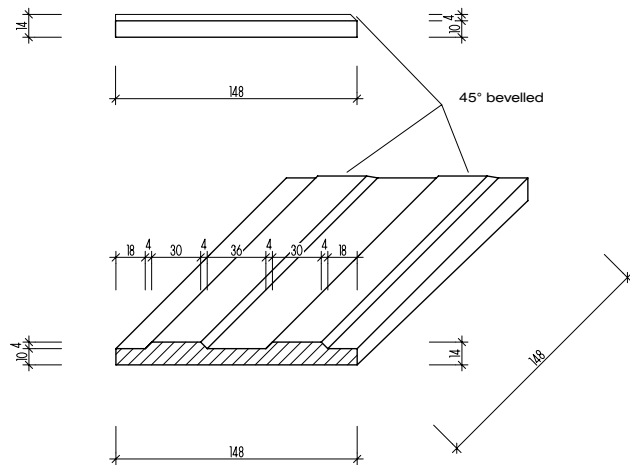

Guide Tiles

15.4 x 15.4 cm



15.4 x 15.4 cm



Ribbed structure

bevelled on one side, ribbed structure

				6635	6636	Model number
				15.4x15.4 / 63/16x63/16	15.4x15.4 / 63/16x63/16	Nom. dim. - cm/in
				148 x 148 x 10 mm	148 x 148 x 10 mm	Work size
				Ribbed structure	Ribbed structure	Surface
				6.494	6.494	m - pieces
				3.318	3.318	m - kg
				20	20	Bundle - pieces
				3.080	3.080	Bundle - m
				10.220	10.220	Bundle - kg
						Pallet - m
						Pallet - kg
				Alb	Alb	Product standard
				R11	R11	Slip resistance
				3	3	Stress group
				103197-6635	103197-6636	
				Price gr. A428 (pce.)	Price gr. A442 (pce.)	chalk
				101630-6635	101630-6636	
				Price gr. A428 (pce.)	Price gr. A442 (pce.)	anthracite



Complying with the requirements of DIN 32984.



Make-to-order production: return and/or cancellation of ordered products not possible.

All products: Color Shade Variation V0.



Project: Oasia Hotel / Location: Singapore / Architect: WOHA Architects + Patricia Urquiola / Series: Serie: Chroma, Chroma non slip / Photo: Infnitude



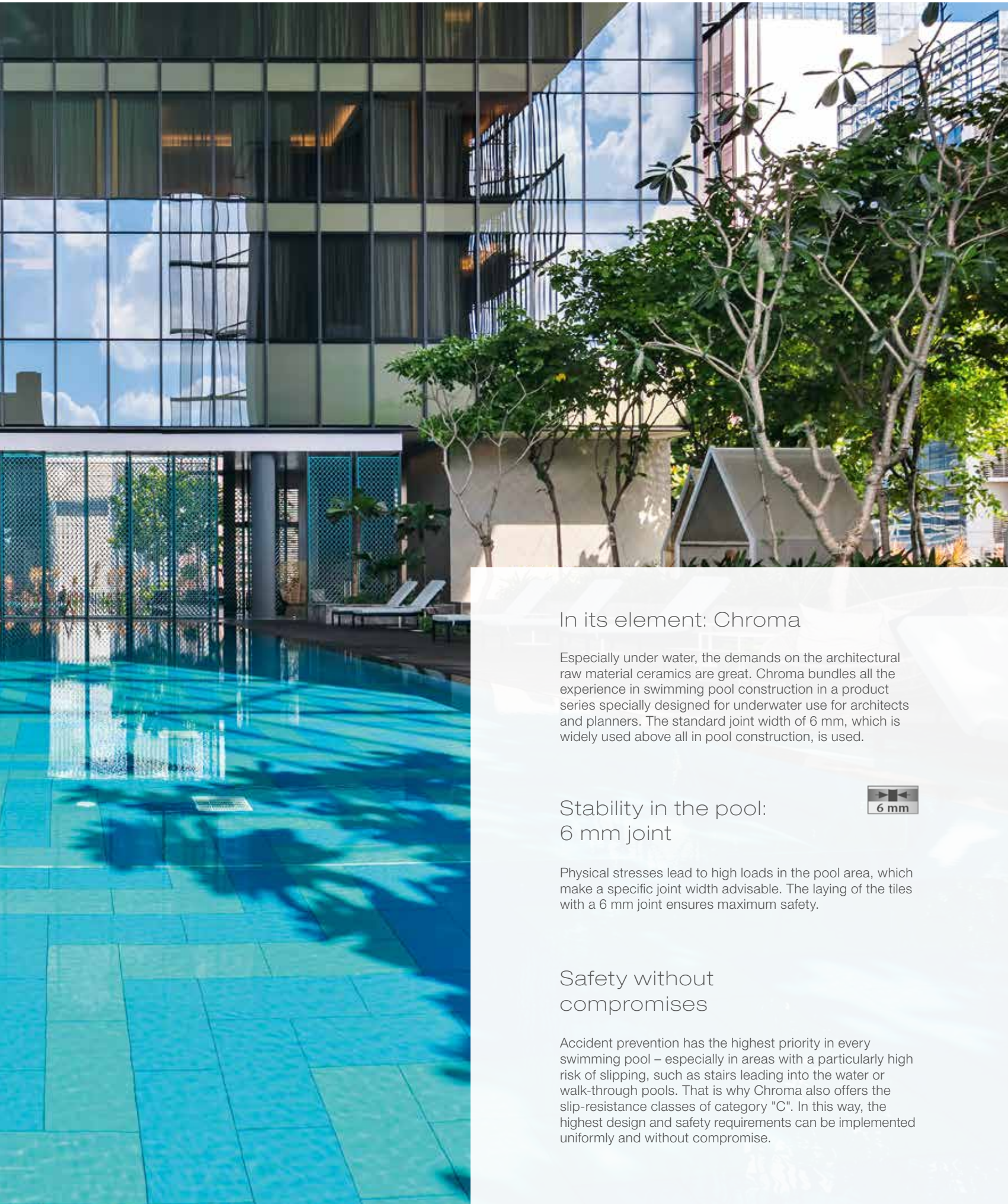

In its element: Chroma

Especially under water, the demands on the architectural raw material ceramics are great. Chroma bundles all the experience in swimming pool construction in a product series specially designed for underwater use for architects and planners. The standard joint width of 6 mm, which is widely used above all in pool construction, is used.

Stability in the pool: 6 mm joint



Physical stresses lead to high loads in the pool area, which make a specific joint width advisable. The laying of the tiles with a 6 mm joint ensures maximum safety.

Safety without compromises

Accident prevention has the highest priority in every swimming pool – especially in areas with a particularly high risk of slipping, such as stairs leading into the water or walk-through pools. That is why Chroma also offers the slip-resistance classes of category "C". In this way, the highest design and safety requirements can be implemented uniformly and without compromise.

COLOR SYSTEM UNICOLOR – A color sphere becomes a sphere of possibilities



Contrasting colors (glossy)

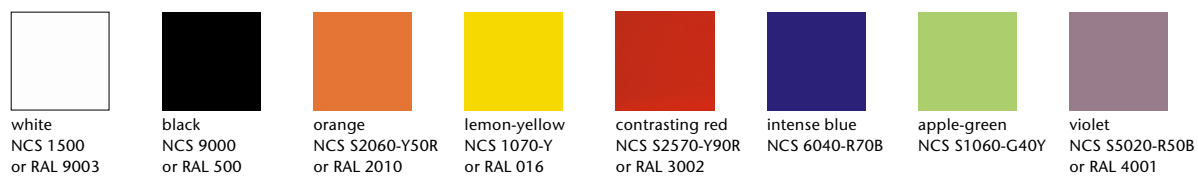

active ochre NCS S 3050-Y40R	active salmon NCS S 4040-Y70R	active oxid red NCS S 4050-Y90R	active stone grey NCS S 5030-Y90R	active sand grey NCS S 7010-Y90R
light ochre NCS S 2030-Y20R	light salmon NCS S 1515-Y50R	light oxid red NCS S 2010-Y80R	light stone grey NCS S 2502-R	light sand grey NCS S 1502-Y
medium ochre NCS S 3030-Y30R	medium salmon NCS S 2020-Y50R	medium oxid red NCS S 3020-Y80R	medium stone grey NCS S 3502-R or RAL 7036	medium sand grey NCS S 3005-Y50R
dark ochre NCS S 4030-Y50R	dark salmon NCS S 3040-Y60R	dark oxid red NCS S 5020-Y80R	dark stone grey NCS S 6005-Y80R	dark sand grey NCS S 6010-Y50R
ochre	salmon	oxid red	stone grey	sand grey
neutral 5 (basalt-grey) NCS S 5502-B or RAL 7046	neutral 4 (graphite-black) NCS S 6000-N or RAL 7037	neutral 3 (asphalt black) NCS S 6500-N	neutral 2 (anthracite) NCS S 7500-N or RAL 7015	neutral 1 (deep black) NCS S 9000-N or RAL 9017

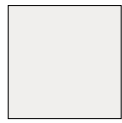

701
neutral 10 (active white)

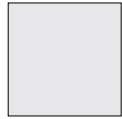

552119
neutral 9 (white-grey)



552118
neutral 8 (light-grey)



552117
neutral 7 (pebble-grey)



552116
neutral 6 (pearl grey)



552115
neutral 5 (basalt-grey)



552114
neutral 4 (graphite-black)



552113
neutral 3 (asphalt black)



552112
neutral 2 (anthracite)



5716
neutral 1 (deep black)



552004
dark azure



552008
dark blue



552012
dark turquoise



552016
dark green



552020
dark yellow



552024
dark ochre



552028
dark salmon



552032
dark oxid red



552036
dark stone grey



552040
dark sand grey



552003
medium azure



552007
medium blue



552011
medium turquoise



552015
medium green



552019
medium yellow



552023
medium ochre



552027
medium salmon



552031
medium oxid red



552035
medium stone grey



552039
medium sand grey



552002
light azure



552006
light blue



552010
light turquoise



552014
light green



552018
light yellow



552022
light ochre



552026
light salmon



552030
light oxid red



552034
light stone grey

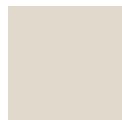

552038
light sand grey



552001
active azure



552005
active blue



552009
active turquoise



552013
active green



552017
active yellow



552021
active ochre



552025
active salmon



552029
active oxide red



552033
active stone grey



552037
active sand grey

Contrasting colors
(glossy)



700
white

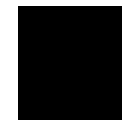

717
black



151
orange



150
lemon-yellow



154
contrasting red



144
intense blue



152
apple-green



153
violet



Floor/Wall tile
6.2 x 25 cm, 2 1/2 x 10 in, smooth



Floor/Wall tile
25 x 25 cm, 10 x 10 in, smooth



Floor/Wall tile
12.5 x 12.5 cm, 5 x 5 in, smooth



Floor/Wall tile
12.5 x 25 cm, 5 x 10 in, smooth

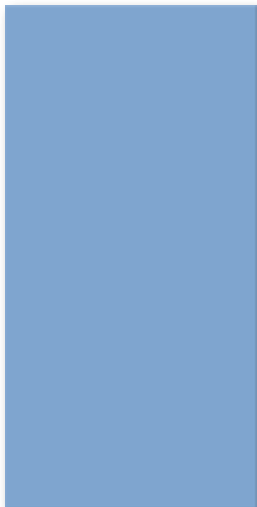

Floor/Wall tile
25 x 50 cm, 10 x 20 in, smooth



Floor/Wall tile
12.5 x 50 cm, 5 x 20 in, smooth

Floor/Wall Tiles

6.2 x 25 cm^{2/6}



12.5 x 12.5 cm^{2/6}



12.5 x 25 cm²



12.5 x 50 cm¹

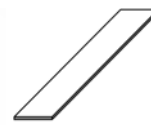

25 x 25 cm²



25 x 50 cm¹

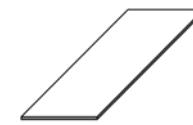

Model number	18210H	12020H	18120H	41550HK	12050H	42550HK
Nom. dim. - cm/in	6.2 x 25 / 2 1/2 x 10	12.5 x 12.5 / 5 x 5	12.5 x 25 / 5 x 10	12.5 x 50 / 5 x 20	25 x 25 / 10 x 10	25 x 50 / 10 x 20
Work size	56 x 244 x 6 mm	119 x 119 x 6 mm	119 x 244 x 6 mm	119 x 494 x 8 mm	244 x 244 x 6 mm	244 x 494 x 8 mm
Surface	smooth, silky-matt ⁵	smooth, silky-matt ⁵	smooth, silky-matt ⁵	smooth, silky-matt ⁵	smooth, silky-matt ⁵	smooth, silky-matt ⁵
m ² - pieces	64.000	64.000	32.000	16.000	16.000	8.000
m ² - kg	10.880	12.160	12.160	17.040	12.800	17.040
Bundle - pieces	88	88	44	8	18	9
Bundle - m ²	1.375	1.375	1.375	0.500	1.125	1.125
Bundle - kg	14.960	16.720	16.720	8.520	14.400	19.170
Pallet - m ²	132.000	115.500	115.500	55.000	91.125	40.500
Pallet - kg	1,436.160	1,404.480	1,404.480	937.200	1,166.400	690.120
Product standard	Alb	Alb	Alb	Alb	Alb	Alb
neutral 10 (active white glossy)	4 700i-18210H Price gr. A157 (m ²)	700i-12020H Price gr. A157 (m ²)	700i-18120H Price gr. A94 (m ²)	700i-41550HK Price gr. A178 (m ²)	700i-12050H Price gr. A157 (m ²)	700i-42550HK Price gr. A157 (m ²)
neutral 10 (active white matt)	4 701i-18210H Price gr. A157 (m ²)	701i-12020H Price gr. A157 (m ²)	701i-18120H Price gr. A94 (m ²)	701i-41550HK Price gr. A178 (m ²)	701i-12050H Price gr. A157 (m ²)	701i-42550HK Price gr. A157 (m ²)
neutral 9 (white grey)	4 552119-18210H³ Price gr. A217 (m ²)	552119-12020H³ Price gr. A217 (m ²)	552119-18120H Price gr. A121 (m ²)	552119-41550HK³ Price gr. A235 (m ²)	552119-12050H³ Price gr. A217 (m ²)	552119-42550HK³ Price gr. A217 (m ²)
neutral 8 (light-grey)	4 552118-18210H Price gr. A187 (m ²)	552118-12020H³ Price gr. A217 (m ²)	552118-18120H Price gr. A121 (m ²)	552118-41550HK³ Price gr. A235 (m ²)	552118-12050H³ Price gr. A217 (m ²)	552118-42550HK³ Price gr. A217 (m ²)
neutral 7 (pebble grey)	4 552117-18210H Price gr. A187 (m ²)	552117-12020H³ Price gr. A217 (m ²)	552117-18120H Price gr. A121 (m ²)	552117-41550HK³ Price gr. A235 (m ²)	552117-12050H Price gr. A187 (m ²)	552117-42550HK³ Price gr. A217 (m ²)
neutral 6 (pearl grey)	3 552116-18210H³ Price gr. A217 (m ²)	552116-12020H³ Price gr. A217 (m ²)	552116-18120H Price gr. A121 (m ²)	552116-41550HK³ Price gr. A235 (m ²)	552116-12050H³ Price gr. A217 (m ²)	552116-42550HK³ Price gr. A217 (m ²)
neutral 5 (basalt grey)	3 552115-18210H³ Price gr. A217 (m ²)	552115-12020H³ Price gr. A217 (m ²)	552115-18120H³ Price gr. A151 (m ²)	552115-41550HK³ Price gr. A235 (m ²)	552115-12050H³ Price gr. A217 (m ²)	552115-42550HK³ Price gr. A217 (m ²)
neutral 4 (graphite black)	3 552114-18210H^{3/4} Price gr. A217 (m ²)	552114-12020H^{3/4} Price gr. A217 (m ²)	552114-18120H^{3/4} Price gr. A151 (m ²)	552114-41550HK^{3/4} Price gr. A235 (m ²)	552114-12050H^{3/4} Price gr. A217 (m ²)	552114-42550HK⁴ Price gr. A187 (m ²)
neutral 3 (asphalt black)	3 552113-18210H³ Price gr. A217 (m ²)	552113-12020H³ Price gr. A217 (m ²)	552113-18120H Price gr. A121 (m ²)	552113-41550HK³ Price gr. A235 (m ²)	552113-12050H³ Price gr. A217 (m ²)	552113-42550HK³ Price gr. A217 (m ²)
neutral 2 (anthracite)	2 552112-18210H Price gr. A187 (m ²)	552112-12020H³ Price gr. A217 (m ²)	552112-18120H Price gr. A121 (m ²)	552112-41550HK³ Price gr. A235 (m ²)	552112-12050H Price gr. A187 (m ²)	552112-42550HK Price gr. A187 (m ²)
neutral 1 (deep black)	1 5716i-18210H⁴ Price gr. A187 (m ²)	5716i-12020H⁴ Price gr. A187 (m ²)	5716i-18120H⁴ Price gr. A121 (m ²)	5716-41550HK⁴ Price gr. A208 (m ²)	5716i-12050H⁴ Price gr. A187 (m ²)	5716i-42550HK⁴ Price gr. A187 (m ²)
active azure	2 552001-18210H Price gr. A187 (m ²)	552001-12020H Price gr. A121 (m ²)	552001-18120H Price gr. A121 (m ²)	552001-41550HK Price gr. A208 (m ²)	552001-12050H Price gr. A187 (m ²)	552001-42550HK Price gr. A187 (m ²)
light azure	4 552002-18210H Price gr. A187 (m ²)	552002-12020H Price gr. A187 (m ²)	552002-18120H Price gr. A121 (m ²)	552002-41550HK Price gr. A208 (m ²)	552002-12050H Price gr. A187 (m ²)	552002-42550HK Price gr. A187 (m ²)
medium azure	3 552003-18210H Price gr. A187 (m ²)	552003-12020H Price gr. A187 (m ²)	552003-18120H Price gr. A121 (m ²)	552003-41550HK³ Price gr. A235 (m ²)	552003-12050H Price gr. A187 (m ²)	552003-42550HK Price gr. A187 (m ²)
dark azure	2 552004-18210H Price gr. A187 (m ²)	552004-12020H Price gr. A187 (m ²)	552004-18120H Price gr. A121 (m ²)	552004-41550HK³ Price gr. A235 (m ²)	552004-12050H³ Price gr. A217 (m ²)	552004-42550HK³ Price gr. A217 (m ²)
active blue	2 552005-18210H³ Price gr. A217 (m ²)	552005-12020H Price gr. A187 (m ²)	552005-18120H Price gr. A121 (m ²)	552005-41550HK³ Price gr. A235 (m ²)	552005-12050H Price gr. A187 (m ²)	552005-42550HK³ Price gr. A217 (m ²)
light blue	4 552006-18210H³ Price gr. A217 (m ²)	552006-12020H Price gr. A187 (m ²)	552006-18120H Price gr. A121 (m ²)	552006-41550HK³ Price gr. A235 (m ²)	552006-12050H Price gr. A187 (m ²)	552006-42550HK Price gr. A187 (m ²)
medium blue	3 552007-18210H Price gr. A187 (m ²)	552007-12020H Price gr. A187 (m ²)	552007-18120H Price gr. A121 (m ²)	552007-41550HK³ Price gr. A235 (m ²)	552007-12050H Price gr. A187 (m ²)	552007-42550HK Price gr. A187 (m ²)
dark blue	2 552008-18210H Price gr. A187 (m ²)	552008-12020H³ Price gr. A217 (m ²)	552008-18120H Price gr. A121 (m ²)	552008-41550HK³ Price gr. A235 (m ²)	552008-12050H³ Price gr. A217 (m ²)	552008-42550HK³ Price gr. A217 (m ²)
active turquoise	2 552009-18210H Price gr. A187 (m ²)	552009-12020H³ Price gr. A217 (m ²)	552009-18120H Price gr. A121 (m ²)	552009-41550HK³ Price gr. A235 (m ²)	552009-12050H³ Price gr. A217 (m ²)	552009-42550HK³ Price gr. A217 (m ²)
light turquoise	4 552010-18210H Price gr. A187 (m ²)	552010-12020H Price gr. A187 (m ²)	552010-18120H Price gr. A121 (m ²)	552010-41550HK³ Price gr. A235 (m ²)	552010-12050H³ Price gr. A217 (m ²)	552010-42550HK³ Price gr. A217 (m ²)
medium turquoise	3 552011-18210H Price gr. A187 (m ²)	552011-12020H Price gr. A187 (m ²)	552011-18120H Price gr. A121 (m ²)	552011-41550HK³ Price gr. A235 (m ²)	552011-12050H Price gr. A187 (m ²)	552011-42550HK³ Price gr. A217 (m ²)
dark turquoise	2 552012-18210H⁴ Price gr. A187 (m ²)	552012-12020H⁴ Price gr. A187 (m ²)	552012-18120H⁴ Price gr. A121 (m ²)	552012-41550HK^{3/4} Price gr. A235 (m ²)	552012-12050H^{3/4} Price gr. A217 (m ²)	552012-42550HK^{3/4} Price gr. A217 (m ²)



 **rectified**

² **Overglazed edges / corners, refer to page 121**

³ **Make-to-order production: return and/or cancellation of ordered products not possible.**



⁴ **Color deviations from the standard due to production reasons are possible.**

⁵ **Exception neutral 10 (active white glossy): smooth, glossy**

⁶ **Supplied as double-tiles; to be broken by customer.**

All products: Color Shade Variation V0

Overglazed edges / corners^{1/2}
Floor/Wall Tiles

6.2 x 25 cm



overglazed
corner left

6.2 x 25 cm



overglazed
corner right

12.5 x 12.5 cm



overglazed
corner left

12.5 x 25 cm



overglazed
corner left

12.5 x 25 cm



overglazed
corner right

25 x 25 cm



overglazed
corner left



Model number	Nom. dim. - cm/in	Work size	Surface	m ² - pieces	m ² - kg	Bundle - pieces	Bundle - m ²	Bundle - kg	Pallet - m ²	Pallet - kg	Product standard	Stress group	neutral 10 (active white glossy)	neutral 10 (active white matt)
18213H	6.2 x 25 / 2 1/2 x 10	56 x 244 x 6 mm	smooth, silky-matt ⁴	64.000	10.880	88	1.375	14.960	132.000	1,436.160	Alb			
18214H	6.2 x 25 / 2 1/2 x 10	56 x 244 x 6 mm	smooth, silky-matt ⁴	64.000	10.880	88	1.375	14.960	132.000	1,436.160	Alb			
12023H	12.5 x 12.5 / 5 x 5	119 x 119 x 6 mm	smooth, silky-matt ⁴	64.000	12.160	88	1.375	16.720	115.500	1,404.480	Alb			
18123H	12.5 x 25 / 5 x 10	119 x 244 x 6 mm	smooth, silky-matt ⁴	32.000	12.160	44	1.375	16.720	115.500	1,404.480	Alb			
18124H	12.5 x 25 / 5 x 10	119 x 244 x 6 mm	smooth, silky-matt ⁴	32.000	12.160	44	1.375	16.720	115.500	1,404.480	Alb			
12053H	25 x 25 / 10 x 10	244 x 244 x 6 mm	smooth, silky-matt ⁴	16.000	12.800	18	1.125	14.400	91.125	1,166.400	Alb			
700i-18213H	Price gr. A157 (m ²)											4	neutral 10 (active white glossy)	
701i-18213H	Price gr. A157 (m ²)											4	neutral 10 (active white matt)	
700i-18214H	Price gr. A157 (m ²)													
701i-18214H	Price gr. A157 (m ²)													
700i-12023H	Price gr. A157 (m ²)													
701i-12023H	Price gr. A157 (m ²)													
700i-18123H	Price gr. A109 (m ²)													
701i-18123H	Price gr. A109 (m ²)													
700i-18124H	Price gr. A109 (m ²)													
701i-18124H	Price gr. A109 (m ²)													
700i-12053H	Price gr. A157 (m ²)													
701i-12053H	Price gr. A157 (m ²)													
5716i-18213H ³	Price gr. A187 (m ²)											1	neutral 1 (deep black)	
552001-18213H	Price gr. A187 (m ²)											2	active azure	
552002-18213H	Price gr. A187 (m ²)											4	light azure	
5716i-18214H ³	Price gr. A187 (m ²)													
552001-18214H	Price gr. A187 (m ²)													
552002-18214H	Price gr. A187 (m ²)													
5716i-12023H ³	Price gr. A187 (m ²)													
552001-12023H	Price gr. A187 (m ²)													
552002-12023H	Price gr. A187 (m ²)													
5716i-18123H ³	Price gr. A136 (m ²)													
552001-18123H	Price gr. A136 (m ²)													
552002-18123H	Price gr. A136 (m ²)													
5716i-18124H ³	Price gr. A136 (m ²)													
552001-18124H	Price gr. A136 (m ²)													
552002-18124H	Price gr. A136 (m ²)													
5716i-12053H ³	Price gr. A187 (m ²)													
552001-12053H	Price gr. A187 (m ²)													
552002-12053H	Price gr. A187 (m ²)													

¹ Other colors available on request.

²  Make-to-order production: return and/or cancellation of ordered products not possible.

³ Production-related color deviations from the standard are possible.

⁴ Exception neutral 10 (active white glossy): smooth, glossy

All products: Color Shade Variation V0



Overglazed edges
available on request:



Replace last figure 0 of
Standard model no. by ...

... 3 = corner left

... 4 = corner right

überglasierte Kanten

Example: Standard model no. 18120 = 119 x 244 x 6 mm,
model no. 18123 = overglazed corner left

Floor/Wall Tiles

6.2 x 25 cm^{2/5}



12.5 x 12.5 cm^{2/5}



12.5 x 25 cm²



12.5 x 50 cm¹

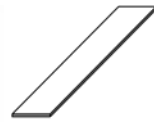

25 x 25 cm²



25 x 50 cm¹

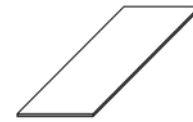

Model number	18210H	12020H	18120H	41550HK	12050H	42550HK
Nom. dim. - cm/in	6.2 x 25 / 2 1/2 x 10	12.5 x 12.5 / 5 x 5	12.5 x 25 / 5 x 10	12.5 x 50 / 5 x 20	25 x 25 / 10 x 10	25 x 50 / 10 x 20
Work size	56 x 244 x 6 mm	119 x 119 x 6 mm	119 x 244 x 6 mm	119 x 494 x 8 mm	244 x 244 x 6 mm	244 x 494 x 8 mm
Surface	smooth, silky-matt	smooth, silky-matt	smooth, silky-matt	smooth, silky-matt	smooth, silky-matt	smooth, silky-matt
m ² - pieces	64.000	64.000	32.000	16.000	16.000	8.000
m ² - kg	10.880	12.160	12.160	17.040	12.800	17.040
Bundle - pieces	88	88	44	8	18	9
Bundle - m ²	1.375	1.375	1.375	0.500	1.125	1.125
Bundle - kg	14.960	16.720	16.720	8.520	14.400	19.170
Pallet - m ²	132.000	115.500	115.500	55.000	91.125	40.500
Pallet - kg	1,436.160	1,404.480	1,404.480	937.200	1,166.400	690.120
Product standard	Alb	Alb	Alb	Alb	Alb	Alb
Stress group	2	2	2	4	2	2
active green	552013-18210H Price gr. A187 (m ²)	552013-12020H Price gr. A187 (m ²)	552013-18120H Price gr. A121 (m ²)	<i>552013-41550HK³</i> Price gr. A235 (m ²)	<i>552013-12050H³</i> Price gr. A217 (m ²)	<i>552013-42550HK³</i> Price gr. A217 (m ²)
light green	552014-18210H Price gr. A187 (m ²)	552014-12020H Price gr. A187 (m ²)	552014-18120H Price gr. A121 (m ²)	<i>552014-41550HK³</i> Price gr. A235 (m ²)	552014-12050H Price gr. A187 (m ²)	<i>552014-42550HK³</i> Price gr. A217 (m ²)
medium green	552015-18210H Price gr. A187 (m ²)	552015-12020H Price gr. A187 (m ²)	552015-18120H Price gr. A121 (m ²)	<i>552015-41550HK³</i> Price gr. A235 (m ²)	552015-12050H Price gr. A187 (m ²)	552015-42550HK Price gr. A187 (m ²)
dark green	552016-18210H Price gr. A187 (m ²)	552016-12020H Price gr. A187 (m ²)	552016-18120H Price gr. A121 (m ²)	<i>552016-41550HK³</i> Price gr. A235 (m ²)	552016-12050H Price gr. A187 (m ²)	<i>552016-42550HK³</i> Price gr. A217 (m ²)
active yellow	<i>552017-18210H^{3/4}</i> Price gr. A217 (m ²)	<i>552017-12020H^{3/4}</i> Price gr. A217 (m ²)	552017-18120H⁴ Price gr. A121 (m ²)	<i>552017-41550HK^{3/4}</i> Price gr. A235 (m ²)	<i>552017-12050H^{3/4}</i> Price gr. A217 (m ²)	<i>552017-42550HK^{3/4}</i> Price gr. A217 (m ²)
light yellow	<i>552018-18210H³</i> Price gr. A217 (m ²)	552018-12020H Price gr. A187 (m ²)	552018-18120H Price gr. A121 (m ²)	<i>552018-41550HK³</i> Price gr. A235 (m ²)	552018-12050H Price gr. A187 (m ²)	552018-42550HK Price gr. A187 (m ²)
medium yellow	552019-18210H Price gr. A187 (m ²)	552019-12020H Price gr. A187 (m ²)	552019-18120H Price gr. A121 (m ²)	<i>552019-41550HK³</i> Price gr. A235 (m ²)	552019-12050H Price gr. A187 (m ²)	<i>552019-42550HK³</i> Price gr. A217 (m ²)
dark yellow	552020-18210H⁴ Price gr. A187 (m ²)	<i>552020-12020H^{3/4}</i> Price gr. A217 (m ²)	552020-18120H⁴ Price gr. A121 (m ²)	<i>552020-41550HK^{3/4}</i> Price gr. A235 (m ²)	<i>552020-12050H^{3/4}</i> Price gr. A217 (m ²)	<i>552020-42550HK^{3/4}</i> Price gr. A217 (m ²)
active ochre	<i>552021-18210H^{3/4}</i> Price gr. A217 (m ²)	<i>552021-12020H^{3/4}</i> Price gr. A217 (m ²)	<i>552021-18120H^{3/4}</i> Price gr. A151 (m ²)	<i>552021-41550HK^{3/4}</i> Price gr. A235 (m ²)	<i>552021-12050H^{3/4}</i> Price gr. A217 (m ²)	<i>552021-42550HK^{3/4}</i> Price gr. A217 (m ²)
light ochre	552022-18210H Price gr. A187 (m ²)	<i>552022-12020H³</i> Price gr. A217 (m ²)	<i>552022-18120H³</i> Price gr. A151 (m ²)	<i>552022-41550HK³</i> Price gr. A235 (m ²)	<i>552022-12050H³</i> Price gr. A217 (m ²)	<i>552022-42550HK³</i> Price gr. A217 (m ²)
medium ochre	<i>552023-18210H³</i> Price gr. A217 (m ²)	<i>552023-12020H³</i> Price gr. A217 (m ²)	552023-18120H Price gr. A121 (m ²)	<i>552023-41550HK³</i> Price gr. A235 (m ²)	<i>552023-12050H³</i> Price gr. A217 (m ²)	<i>552023-42550HK³</i> Price gr. A217 (m ²)
dark ochre	<i>552024-18210H³</i> Price gr. A217 (m ²)	<i>552024-12020H³</i> Price gr. A217 (m ²)	552024-18120H Price gr. A121 (m ²)	<i>552024-41550HK³</i> Price gr. A235 (m ²)	<i>552024-12050H³</i> Price gr. A217 (m ²)	<i>552024-42550HK³</i> Price gr. A217 (m ²)
active salmon	552025-18210H⁴ Price gr. A187 (m ²)	<i>552025-12020H^{3/4}</i> Price gr. A217 (m ²)	<i>552025-18120H^{3/4}</i> Price gr. A151 (m ²)	<i>552025-41550HK^{3/4}</i> Price gr. A235 (m ²)	<i>552025-12050H^{3/4}</i> Price gr. A217 (m ²)	<i>552025-42550HK^{3/4}</i> Price gr. A217 (m ²)
light salmon	552026-18210H Price gr. A187 (m ²)	<i>552026-12020H³</i> Price gr. A217 (m ²)	552026-18120H Price gr. A121 (m ²)	<i>552026-41550HK³</i> Price gr. A235 (m ²)	<i>552026-12050H³</i> Price gr. A217 (m ²)	<i>552026-42550HK³</i> Price gr. A217 (m ²)
medium salmon	552027-18210H Price gr. A187 (m ²)	<i>552027-12020H³</i> Price gr. A217 (m ²)	<i>552027-18120H³</i> Price gr. A151 (m ²)	<i>552027-41550HK³</i> Price gr. A235 (m ²)	552027-12050H Price gr. A187 (m ²)	<i>552027-42550HK³</i> Price gr. A217 (m ²)
dark salmon	<i>552028-18210H³</i> Price gr. A217 (m ²)	<i>552028-12020H³</i> Price gr. A217 (m ²)	<i>552028-18120H³</i> Price gr. A151 (m ²)	<i>552028-41550HK³</i> Price gr. A235 (m ²)	<i>552028-12050H³</i> Price gr. A217 (m ²)	<i>552028-42550HK³</i> Price gr. A217 (m ²)
active oxide red	552029-18210H Price gr. A187 (m ²)	<i>552029-12020H³</i> Price gr. A217 (m ²)	552029-18120H Price gr. A121 (m ²)	<i>552029-41550HK³</i> Price gr. A235 (m ²)	552029-12050H Price gr. A187 (m ²)	<i>552029-42550HK³</i> Price gr. A217 (m ²)
light oxide red	<i>552030-18210H³</i> Price gr. A217 (m ²)	<i>552030-12020H³</i> Price gr. A217 (m ²)	<i>552030-18120H³</i> Price gr. A151 (m ²)	<i>552030-41550HK³</i> Price gr. A235 (m ²)	552030-12050H Price gr. A187 (m ²)	<i>552030-42550HK³</i> Price gr. A217 (m ²)
medium oxide red	552031-18210H Price gr. A187 (m ²)	<i>552031-12020H³</i> Price gr. A217 (m ²)	<i>552031-18120H³</i> Price gr. A151 (m ²)	<i>552031-41550HK³</i> Price gr. A235 (m ²)	552031-12050H Price gr. A187 (m ²)	<i>552031-42550HK³</i> Price gr. A217 (m ²)
dark oxide red	552032-18210H Price gr. A187 (m ²)	<i>552032-12020H³</i> Price gr. A217 (m ²)	552032-18120H Price gr. A121 (m ²)	<i>552032-41550HK³</i> Price gr. A235 (m ²)	<i>552032-12050H³</i> Price gr. A217 (m ²)	<i>552032-42550HK³</i> Price gr. A217 (m ²)



 rectified

² Overglazed edges / corners, refer to page 121

³  Make-to-order production: return and/or cancellation of ordered products not possible.

⁴ Color deviations from the standard due to production reasons are possible.

⁵ Supplied as double-tiles; to be broken by customer.

All products: Color Shade Variation V0

Floor/Wall Tiles

6.2 x 25 cm^{2/4}



12.5 x 12.5 cm^{2/4}



12.5 x 25 cm²



12.5 x 50 cm¹

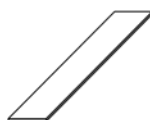

25 x 25 cm²



25 x 50 cm¹



	18210H	12020H	18120H	41550HK	12050H	42550HK	
	6.2 x 25 / 2 1/2 x 10	12.5 x 12.5 / 5 x 5	12.5 x 25 / 5 x 10	12.5 x 50 / 5 x 20	25 x 25 / 10 x 10	25 x 50 / 10 x 20	Model number
	56 x 244 x 6 mm	119 x 119 x 6 mm	119 x 244 x 6 mm	119 x 494 x 8 mm	244 x 244 x 6 mm	244 x 494 x 8 mm	Nom. dim. - cm/in
	smooth, silky-matt ⁶	smooth, silky-matt ⁶	smooth, silky-matt ⁶	smooth, silky-matt ⁶	smooth, silky-matt ⁶	smooth, silky-matt ⁶	Surface
	64.000	64.000	32.000	16.000	16.000	8.000	m ² - pieces
	10.880	12.160	12.160	17.040	12.800	17.040	m ² - kg
	88	88	44	8	18	9	Bundle - pieces
	1.375	1.375	1.375	0.500	1.125	1.125	Bundle - m ²
	14.960	16.720	16.720	8.520	14.400	19.170	Bundle - kg
	132.000	115.500	115.500	55.000	91.125	40.500	Pallet - m ²
	1,436.160	1,404.480	1,404.480	937.200	1,166.400	690.120	Pallet - kg
	Alb	Alb	Alb	Alb	Alb	Alb	Product standard
	552033-18210H	552033-12020H ³	552033-18120H	552033-41550HK ³	552033-12050H ³	552033-42550HK ³	2
	Price gr. A187 (m ²)	Price gr. A217 (m ²)	Price gr. A121 (m ²)	Price gr. A235 (m ²)	Price gr. A217 (m ²)	Price gr. A217 (m ²)	active stone grey
	552034-18210H ³	552034-12020H ³	552034-18120H ³	552034-41550HK ³	552034-12050H ³	552034-42550HK ³	4
	Price gr. A217 (m ²)	Price gr. A217 (m ²)	Price gr. A151 (m ²)	Price gr. A235 (m ²)	Price gr. A217 (m ²)	Price gr. A217 (m ²)	light stone grey
	552035-18210H	552035-12020H	552035-18120H	552035-41550HK ³	552035-12050H ³	552035-42550HK ³	3
	Price gr. A187 (m ²)	Price gr. A187 (m ²)	Price gr. A121 (m ²)	Price gr. A235 (m ²)	Price gr. A217 (m ²)	Price gr. A217 (m ²)	medium stone grey
	552036-18210H ³	552036-12020H ³	552036-18120H	552036-41550HK ³	552036-12050H ³	552036-42550HK ³	2
	Price gr. A217 (m ²)	Price gr. A217 (m ²)	Price gr. A121 (m ²)	Price gr. A235 (m ²)	Price gr. A217 (m ²)	Price gr. A217 (m ²)	dark stone grey
	552037-18210H ³	552037-12020H ³	552037-18120H	552037-41550HK ³	552037-12050H ³	552037-42550HK ³	2
	Price gr. A217 (m ²)	Price gr. A217 (m ²)	Price gr. A121 (m ²)	Price gr. A235 (m ²)	Price gr. A217 (m ²)	Price gr. A217 (m ²)	active sand-grey
	552038-18210H	552038-12020H	552038-18120H	552038-41550HK ³	552038-12050H³	552038-42550HK ³	4
	Price gr. A187 (m ²)	Price gr. A187 (m ²)	Price gr. A121 (m ²)	Price gr. A235 (m ²)	Price gr. A187 (m ²)	Price gr. A217 (m ²)	light sand-grey
	552039-18210H ³	552039-12020H ³	552039-18120H	552039-41550HK ³	552039-12050H ³	552039-42550HK ³	3
	Price gr. A217 (m ²)	Price gr. A217 (m ²)	Price gr. A121 (m ²)	Price gr. A235 (m ²)	Price gr. A217 (m ²)	Price gr. A217 (m ²)	medium sand-grey
	552040-18210H ³	552040-12020H ³	552040-18120H	552040-41550HK ³	552040-12050H ³	552040-42550HK	2
	Price gr. A217 (m ²)	Price gr. A217 (m ²)	Price gr. A121 (m ²)	Price gr. A235 (m ²)	Price gr. A217 (m ²)	Price gr. A187 (m ²)	dark sand-grey
	717i-18210H ³	717i-12020H ³	717i-18120H ³	717i-41550HK ³	717i-12050H ³	717i-42550HK ³	1
	Price gr. A217 (m ²)	Price gr. A217 (m ²)	Price gr. A151 (m ²)	Price gr. A235 (m ²)	Price gr. A217 (m ²)	Price gr. A217 (m ²)	black glossy
	151i-18210H ³	151i-12020H ³	151i-18120H ³	151i-41550HK ³	151i-12050H ³	151i-42550HK ³	1
	Price gr. A217 (m ²)	Price gr. A217 (m ²)	Price gr. A151 (m ²)	Price gr. A235 (m ²)	Price gr. A217 (m ²)	Price gr. A217 (m ²)	orange glossy
	150i-18210H ³	150i-12020H ³	150i-18120H ³	150i-41550HK ³	150i-12050H ³	150i-42550HK ³	2
	Price gr. A217 (m ²)	Price gr. A217 (m ²)	Price gr. A151 (m ²)	Price gr. A235 (m ²)	Price gr. A217 (m ²)	Price gr. A217 (m ²)	lemon-yellow glossy
	154i-18210H ³	154i-12020H ³	154i-18120H ³	154i-41550HK ³	154i-12050H ³	154i-42550HK ³	1
	Price gr. A217 (m ²)	Price gr. A217 (m ²)	Price gr. A151 (m ²)	Price gr. A235 (m ²)	Price gr. A217 (m ²)	Price gr. A217 (m ²)	contrasting red glossy
	144-18210 ^{3/5}	144-12020 ^{3/5}	144-18120 ^{3/5}	144-41550K ^{3/5}	144-12050 ^{3/5}	144-42550K ^{3/5}	1
	Price gr. A217 (m ²)	Price gr. A217 (m ²)	Price gr. A151 (m ²)	Price gr. A235 (m ²)	Price gr. A217 (m ²)	Price gr. A217 (m ²)	intense blue glossy
	152i-18210H ³	152i-12020H ³	152i-18120H ³	152i-41550HK ³	152i-12050H ³	152i-42550HK ³	2
	Price gr. A217 (m ²)	Price gr. A217 (m ²)	Price gr. A151 (m ²)	Price gr. A235 (m ²)	Price gr. A217 (m ²)	Price gr. A217 (m ²)	apple-green glossy
	153i-18210H ³	153i-12020H ³	153i-18120H ³	153i-41550HK ³	153i-12050H ³	153i-42550HK ³	1
	Price gr. A217 (m ²)	Price gr. A217 (m ²)	Price gr. A151 (m ²)	Price gr. A235 (m ²)	Price gr. A217 (m ²)	Price gr. A217 (m ²)	violet glossy



² Overglazed edges / corners, refer to page 121

³ Make-to-order production: return and/or cancellation of ordered products not possible.

⁴ Supplied as double-tiles; to be broken by customer.

⁵ without Hytect coating

⁶ Exception: contrasting colors black, orange, lemon-yellow, contrasting red, intense blue, apple-green, violet: smooth, glossy

All products: Color Shade Variation V0

Overglazed edges
available on request:



Replace last figure 0 of
Standard model no. by ...

... 3 = corner left

... 4 = corner right

overglazed edges

Example: Standard model no. 18120 = 119 x 244 x 6 mm,
model no. 18123 = overglazed corner left



Project: Solebad (brine bath) / Location: Werne, Germany / Architect: Geising + Böker GmbH, Vechta office / Series: Chroma non-slip, Chroma Pool / Photo: Jochen Stüber







Slip resistance "B"

-/B



91 white / neutral 10 (active white)



553119 neutral 9 (white-grey)



553118 neutral 8 (light-grey)



553117 neutral 7 (pebble-grey)



553116 neutral 6 (pearl grey)



553115 neutral 5 (basalt grey)



553114 neutral 4 (graphite black)



553113 neutral 3 (asphalt black)



553112 neutral 2 (anthracite)



340 black / neutral 1 (deep black)

-/B



553004 dark azure



553008 dark blue



553016 dark green



553036 dark stone grey



553040 dark sand grey



553003 medium azure



553007 medium blue



553011 medium turquoise



553015 medium green



553019 medium yellow



553023 medium ochre



553027 medium salmon



553031 medium oxide red



553035 medium stone grey



553039 medium sand grey



553002 light azure

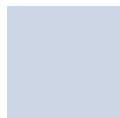

553006 light blue



553010 light turquoise



553014 light green



553018 light yellow



553026 light salmon



553034 light stone grey



553038 light sand grey

-/B



553001 active azure



553033 active stone grey



553037 active sand grey

-/B



77 contrasting red



Floor tile
12.5 x 12.5 cm, 5 x 5 in, smooth, -/B



Floor tile
12.5 x 25 cm, 5 x 10 in, smooth, -/B



Floor tile
25 x 25 cm, 10 x 10 in, smooth, -/B

On request, other colors of the series Chroma are also available as non-slip glazes with a joint width of 6 mm.

Slip resistance „B“

Floor Tiles²

12.5 x 12.5 cm³



12.5 x 25 cm



25 x 25 cm



	32020H	38110H	32050H	Model number
	12.5 x 12.5 / 5 x 5	12.5 x 25 / 5 x 10	25 x 25 / 10 x 10	Nom. dim. - cm/in
	119 x 119 x 8 mm	119 x 244 x 8 mm	244 x 244 x 8 mm	Work size
	smooth, silky-matt	smooth, silky-matt	smooth, silky-matt	Surface
	64.000	32.000	16.000	m ² - pieces
	15.360	15.680	16.960	m ² - kg
	66	33	14	Bundle - pieces
	1.031	1.031	0.875	Bundle - m ²
	15.840	16.170	14.840	Bundle - kg
	86.625	86.625	70.875	Pallet - m ²
	1,330.560	1,358.280	1,202.040	Pallet - kg
	Alb	Alb	Alb	Product standard
	-/B	-/B	-/B	Slip resistance
	2	2	2	Stress group
	91i-32020H	91i-38110H	91i-32050H	neutral 10
	Price gr. A217 (m ²)	Price gr. A199 (m ²)	Price gr. A217 (m ²)	(active white)
	340i-32020H	340i-38110H	340i-32050H	neutral 1
	Price gr. A217 (m ²)	Price gr. A199 (m ²)	Price gr. A217 (m ²)	(deep black)
	553001-32020H	553001-38110H	553001-32050H	active azure
	Price gr. A217 (m ²)	Price gr. A199 (m ²)	Price gr. A217 (m ²)	
	553002-32020H	553002-38110H	553002-32050H	light azure
	Price gr. A217 (m ²)	Price gr. A199 (m ²)	Price gr. A217 (m ²)	
	553003-32020H	553003-38110H	553003-32050H	medium azure
	Price gr. A217 (m ²)	Price gr. A199 (m ²)	Price gr. A217 (m ²)	
	553004-32020H	553004-38110H	553004-32050H	dark azure
	Price gr. A217 (m ²)	Price gr. A199 (m ²)	Price gr. A217 (m ²)	
	553006-32020H	553006-38110H	553006-32050H	light blue
	Price gr. A217 (m ²)	Price gr. A199 (m ²)	Price gr. A217 (m ²)	
	553007-32020H	553007-38110H	553007-32050H	medium blue
	Price gr. A217 (m ²)	Price gr. A199 (m ²)	Price gr. A217 (m ²)	
	553008-32020H	<i>553008-38110H¹</i>	<i>553008-32050H¹</i>	dark blue
	Price gr. A217 (m ²)	Price gr. A199 (m ²)	Price gr. A217 (m ²)	
	553010-32020H	553010-38110H	<i>553010-32050H¹</i>	light turquoise
	Price gr. A217 (m ²)	Price gr. A199 (m ²)	Price gr. A217 (m ²)	
	553011-32020H	553011-38110H	553011-32050H	medium turquoise
	Price gr. A217 (m ²)	Price gr. A199 (m ²)	Price gr. A217 (m ²)	
	553014-32020H	<i>553014-38110H¹</i>	<i>553014-32050H¹</i>	light green
	Price gr. A217 (m ²)	Price gr. A199 (m ²)	Price gr. A217 (m ²)	
	553015-32020H	553015-38110H	553015-32050H	medium green
	Price gr. A217 (m ²)	Price gr. A199 (m ²)	Price gr. A217 (m ²)	
	553016-32020H	553016-38110H	553016-32050H	dark green
	Price gr. A217 (m ²)	Price gr. A199 (m ²)	Price gr. A217 (m ²)	
	<i>553018-32020H¹</i>	<i>553018-38110H¹</i>	<i>553018-32050H¹</i>	light yellow
	Price gr. A217 (m ²)	Price gr. A199 (m ²)	Price gr. A217 (m ²)	
	553019-32020H	553019-38110H	553019-32050H	medium yellow
	Price gr. A217 (m ²)	Price gr. A199 (m ²)	Price gr. A217 (m ²)	
	<i>553023-32020H¹</i>	553023-38110H	553023-32050H	medium ochre
	Price gr. A217 (m ²)	Price gr. A199 (m ²)	Price gr. A217 (m ²)	
	<i>553026-32020H¹</i>	<i>553026-38110H¹</i>	<i>553026-32050H¹</i>	light salmon
	Price gr. A217 (m ²)	Price gr. A199 (m ²)	Price gr. A217 (m ²)	
	<i>553027-32020H¹</i>	553027-38110H	553027-32050H	medium salmon
	Price gr. A217 (m ²)	Price gr. A199 (m ²)	Price gr. A217 (m ²)	
	553031-32020H	<i>553031-38110H¹</i>	<i>553031-32050H¹</i>	medium oxide red
	Price gr. A217 (m ²)	Price gr. A199 (m ²)	Price gr. A217 (m ²)	
	<i>553033-32020H¹</i>	<i>553033-38110H¹</i>	<i>553033-32050H¹</i>	active stone grey
	Price gr. A217 (m ²)	Price gr. A199 (m ²)	Price gr. A217 (m ²)	
	553034-32020H	<i>553034-38110H¹</i>	<i>553034-32050H¹</i>	light stone grey
	Price gr. A217 (m ²)	Price gr. A199 (m ²)	Price gr. A217 (m ²)	
	553035-32020H	553035-38110H	<i>553035-32050H¹</i>	medium stone grey
	Price gr. A217 (m ²)	Price gr. A199 (m ²)	Price gr. A217 (m ²)	
	553036-32020H	553036-38110H	<i>553036-32050H¹</i>	dark stone grey
	Price gr. A217 (m ²)	Price gr. A199 (m ²)	Price gr. A217 (m ²)	

¹ Make-to-order production: return and/or cancellation of ordered products not possible.



² Rounded edges / corners refer to page 129

³ Supplied as double-tiles; to be broken by customer.

All products: Color Shade Variation V0

Slip resistance „B“

Floor Tiles²

12.5 x 12.5 cm³

12.5 x 25 cm

25 x 25 cm



Model number	32020H	38110H	32050H			
Nom. dim. - cm/in	12.5 x 12.5 / 5 x 5	12.5 x 25 / 5 x 10	25 x 25 / 10 x 10			
Work size	119 x 119 x 8 mm	119 x 244 x 8 mm	244 x 244 x 8 mm			
Surface	smooth, silky-matt	smooth, silky-matt	smooth, silky-matt			
m ² - pieces	64.000	32.000	16.000			
m ² - kg	15.360	15.680	16.960			
Bundle - pieces	66	33	14			
Bundle - m ²	1.031	1.031	0.875			
Bundle - kg	15.840	16.170	14.840			
Pallet - m ²	86.625	86.625	70.875			
Pallet - kg	1,330.500	1,358.280	1,202.040			
Product standard	Alb	Alb	Alb			
Slip resistance	-/B ☒	-/B ☒	-/B ☒			
Stress group	2	2	2			
active sand-grey	553037-32020H ¹ Price gr. A217 (m ²)	553037-38110H ¹ Price gr. A199 (m ²)	553037-32050H ¹ Price gr. A217 (m ²)			
light sand-grey	553038-32020H Price gr. A217 (m ²)	553038-38110H Price gr. A199 (m ²)	553038-32050H ¹ Price gr. A217 (m ²)			
medium sand-grey	553039-32020H Price gr. A217 (m ²)	553039-38110H ¹ Price gr. A199 (m ²)	553039-32050H ¹ Price gr. A217 (m ²)			
dark sand-grey	553040-32020H Price gr. A217 (m ²)	553040-38110H ¹ Price gr. A199 (m ²)	553040-32050H ¹ Price gr. A217 (m ²)			
neutral 9 (white grey)	553119-32020H ¹ Price gr. A217 (m ²)	553119-38110H ¹ Price gr. A199 (m ²)	553119-32050H Price gr. A217 (m ²)			
neutral 8 (light-grey)	553118-32020H Price gr. A217 (m ²)	553118-38110H ¹ Price gr. A199 (m ²)	553118-32050H Price gr. A217 (m ²)			
neutral 7 (pebble grey)	553117-32020H Price gr. A217 (m ²)	553117-38110H Price gr. A199 (m ²)	553117-32050H Price gr. A217 (m ²)			
neutral 6 (pearl grey)	553116-32020H ¹ Price gr. A217 (m ²)	553116-38110H Price gr. A199 (m ²)	553116-32050H ¹ Price gr. A217 (m ²)			
neutral 5 (basalt grey)	553115-32020H ¹ Price gr. A217 (m ²)	553115-38110H ¹ Price gr. A199 (m ²)	553115-32050H ¹ Price gr. A217 (m ²)			
neutral 4 (graphite black)	553114-32020H ¹ Price gr. A217 (m ²)	553114-38110H ¹ Price gr. A199 (m ²)	553114-32050H Price gr. A217 (m ²)			
neutral 3 (asphalt black)	553113-32020H Price gr. A217 (m ²)	553113-38110H Price gr. A199 (m ²)	553113-32050H Price gr. A217 (m ²)			
neutral 2 (anthracite)	553112-32020H Price gr. A217 (m ²)	553112-38110H Price gr. A199 (m ²)	553112-32050H Price gr. A217 (m ²)			
contrasting red	77i-32020H Price gr. A217 (m ²)	77i-38110H Price gr. A199 (m ²)	77i-32050H Price gr. A217 (m ²)			



¹ Make-to-order production: return and/or cancellation of ordered products not possible.

² Rounded edges / corners refer to page 129

³ Supplied as double-tiles; to be broken by customer.

All products: Color Shade Variation V0

Slip resistance „B“ – rounded edges/corners^{1/2}

Floor Tiles

12.5 x 12.5 cm



12.5 x 12.5 cm



12.5 x 25 cm



12.5 x 25 cm



12.5 x 25 cm



12.5 x 25 cm



rounded edge	rounded corner	short side rounded	long side rounded	rounded corner left	rounded corner right
32025H	32027H	38115H	38116H	38117H	38118H
12.5 x 12.5 / 5 x 5	12.5 x 12.5 / 5 x 5	12.5 x 25 / 5 x 10	12.5 x 25 / 5 x 10	12.5 x 25 / 5 x 10	12.5 x 25 / 5 x 10
119 x 119 x 8 mm	119 x 119 x 8 mm	119 x 244 x 8 mm	119 x 244 x 8 mm	119 x 244 x 8 mm	119 x 244 x 8 mm
smooth, silky-matt	smooth, silky-matt	smooth, silky-matt	smooth, silky-matt	smooth, silky-matt	smooth, silky-matt
0.240	0.240	0.490	0.490	0.490	0.490
66	66	33	33	33	33
15.840	15.840	16.170	16.170	16.170	16.170
Alb	Alb	Alb	Alb	Alb	Alb
-/B	-/B	-/B	-/B	-/B	-/B
2	2	2	2	2	2
91i-32025H	91i-32027H	91i-38115H	91i-38116H	91i-38117H	91i-38118H
Price gr. A410 (pce.)	Price gr. A410 (pce.)	Price gr. A416 (pce.)	Price gr. A416 (pce.)	Price gr. A416 (pce.)	Price gr. A416 (pce.)
340i-32025H	340i-32027H	340i-38115H	340i-38116H	340i-38117H	340i-38118H
Price gr. A410 (pce.)	Price gr. A410 (pce.)	Price gr. A416 (pce.)	Price gr. A416 (pce.)	Price gr. A416 (pce.)	Price gr. A416 (pce.)
553001-32025H	553001-32027H	553001-38115H	553001-38116H	553001-38117H	553001-38118H
Price gr. A410 (pce.)	Price gr. A410 (pce.)	Price gr. A416 (pce.)	Price gr. A416 (pce.)	Price gr. A416 (pce.)	Price gr. A416 (pce.)
553002-32025H	553002-32027H	553002-38115H	553002-38116H	553002-38117H	553002-38118H
Price gr. A410 (pce.)	Price gr. A410 (pce.)	Price gr. A416 (pce.)	Price gr. A416 (pce.)	Price gr. A416 (pce.)	Price gr. A416 (pce.)



Model number
Nom. dim. - cm/in
Work size
Surface
m ² - pieces
pieces - kg
Bundle - pieces
Bundle - m ²
Bundle - kg
Pallet - m ²
Pallet - kg
Product standard
Slip resistance
Stress group
neutral 10
(active white)
neutral 1
(deep black)
active azure
light azure



25 x 25 cm



25 x 25 cm



rounded edge	rounded corner
32055H	32057H
25 x 25 / 10 x 10	25 x 25 / 10 x 10
244 x 244 x 8 mm	244 x 244 x 8 mm
smooth, silky-matt	smooth, silky-matt
1.060	1.060
14	14
14.840	14.840
Alb	Alb
-/B	-/B
2	2
91i-32055H	91i-32057H
Price gr. A434 (pce.)	Price gr. A434 (pce.)
340i-32055H	340i-32057H
Price gr. A434 (pce.)	Price gr. A434 (pce.)
553001-32055H	553001-32057H
Price gr. A434 (pce.)	Price gr. A434 (pce.)
553002-32055H	553002-32057H
Price gr. A434 (pce.)	Price gr. A434 (pce.)



Model number
Nom. dim. - cm/in
Work size
Surface
m ² - pieces
pieces - kg
Bundle - pieces
Bundle - m ²
Bundle - kg
Pallet - m ²
Pallet - kg
Product standard
Slip resistance
Stress group
neutral 10
(active white)
neutral 1
(deep black)
active azure
light azure



¹ Other colors available on request.
² Make-to-order production: return and/or cancellation of ordered products not possible.
All products: Color Shade Variation V0

Rounded edges			overglazed edges	Example: Standard model no. 38110 = 119 x 244 x 6 mm, model no. 38117 = rounded corner left
Replace last figure 0 of Standard model no. by 7 = corner left	... 8 = corner right		

Slip resistance "C"

-/C



81 white / neutral 10 (active white)



554119 neutral 9 (white-grey)



554118 neutral 8 (light-grey)



554117 neutral 7 (pebble-grey)



554113 neutral 3 (asphalt black)



554111 black / neutral 1 (deep black)

-/C



554004 dark azure



554008 dark blue



554016 dark green



554036 dark stone grey



554040 dark sand grey



554003 medium azure



554007 medium blue



554011 medium turquoise

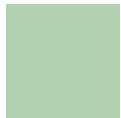

554015 medium green



554019 medium yellow



554023 medium ochre



554027 medium salmon



554031 medium oxide red



554035 medium stone grey



554039 medium sand grey



554002 light azure



554006 light blue



554010 light turquoise



554014 light green



554026 light salmon



554038 light sand grey

-/C



554001 active azure

-/C



78 contrasting red



Floor tile
12.5 x 12.5 cm, 5 x 5 in, structured, -/C



Floor tile
12.5 x 25 cm, 5 x 10 in, structured, -/C



Floor tile
25 x 25 cm, 10 x 10 in, structured, -/C

On request, other colors of the series Chroma are also available as non-slip glazes with a joint width of 6 mm.

Slip resistance „C“
Floor Tiles²

12.5 x 12.5 cm³



12.5 x 25 cm



25 x 25 cm



				32020H	38110H	32050H	Model number
				12.5 x 12.5 / 5 x 5	12.5 x 25 / 5 x 10	25 x 25 / 10 x 10	Nom. dim. - cm/in
				119 x 119 x 8 mm	119 x 244 x 8 mm	244 x 244 x 8 mm	Work size
				structured, silky-matt	structured, silky-matt	structured, silky-matt	Surface
				64.000	32.000	16.000	m ² - pieces
				15.360	15.680	16.960	m ² - kg
				66	33	14	Bundle - pieces
				1.031	1.031	0.875	Bundle - m ²
				15.840	16.170	14.840	Bundle - kg
				86.625	86.625	70.875	Pallet - m ²
				1,330.560	1,358.280	1,202.040	Pallet - kg
				Alb	Alb	Alb	Product standard
				-/C	-/C	-/C	Slip resistance
				2	2	2	Stress group
				81i-32020H	81i-38110H	81i-32050H	neutral 10
				Price gr. A217 (m ²)	Price gr. A199 (m ²)	Price gr. A217 (m ²)	(active white)
				554111-32020H	554111-38110H	554111-32050H¹	neutral 1
				Price gr. A217 (m ²)	Price gr. A199 (m ²)	Price gr. A217 (m ²)	(deep black)
				554001-32020H	554001-38110H	554001-32050H¹	active azure
				Price gr. A217 (m ²)	Price gr. A199 (m ²)	Price gr. A217 (m ²)	
				554002-32020H	554002-38110H	554002-32050H	light azure
				Price gr. A217 (m ²)	Price gr. A199 (m ²)	Price gr. A217 (m ²)	
				554003-32020H	554003-38110H	554003-32050H	medium azure
				Price gr. A217 (m ²)	Price gr. A199 (m ²)	Price gr. A217 (m ²)	
				554004-32020H	554004-38110H	554004-32050H¹	dark azure
				Price gr. A217 (m ²)	Price gr. A199 (m ²)	Price gr. A217 (m ²)	
				554006-32020H	554006-38110H	554006-32050H¹	light blue
				Price gr. A217 (m ²)	Price gr. A199 (m ²)	Price gr. A217 (m ²)	
				554007-32020H	554007-38110H	554007-32050H¹	medium blue
				Price gr. A217 (m ²)	Price gr. A199 (m ²)	Price gr. A217 (m ²)	
				554008-32020H	554008-38110H	554008-32050H¹	dark blue
				Price gr. A217 (m ²)	Price gr. A199 (m ²)	Price gr. A217 (m ²)	
				554010-32020H	554010-38110H	554010-32050H¹	light turquoise
				Price gr. A217 (m ²)	Price gr. A199 (m ²)	Price gr. A217 (m ²)	
				554011-32020H	554011-38110H	554011-32050H¹	medium turquoise
				Price gr. A217 (m ²)	Price gr. A199 (m ²)	Price gr. A217 (m ²)	
				554014-32020H	554014-38110H¹	554014-32050H¹	light green
				Price gr. A217 (m ²)	Price gr. A199 (m ²)	Price gr. A217 (m ²)	
				554015-32020H	554015-38110H¹	554015-32050H¹	medium green
				Price gr. A217 (m ²)	Price gr. A199 (m ²)	Price gr. A217 (m ²)	
				554016-32020H	554016-38110H	554016-32050H	dark green
				Price gr. A217 (m ²)	Price gr. A199 (m ²)	Price gr. A217 (m ²)	
				554019-32020H	554019-38110H	554019-32050H¹	medium yellow
				Price gr. A217 (m ²)	Price gr. A199 (m ²)	Price gr. A217 (m ²)	
				554023-32020H	554023-38110H	554023-32050H	medium ochre
				Price gr. A217 (m ²)	Price gr. A199 (m ²)	Price gr. A217 (m ²)	
				554026-32020H¹	554026-38110H¹	554026-32050H¹	light salmon
				Price gr. A217 (m ²)	Price gr. A199 (m ²)	Price gr. A217 (m ²)	
				554027-32020H	554027-38110H	554027-32050H¹	medium salmon
				Price gr. A217 (m ²)	Price gr. A199 (m ²)	Price gr. A217 (m ²)	
				554031-32020H	554031-38110H	554031-32050H¹	medium oxide red
				Price gr. A217 (m ²)	Price gr. A199 (m ²)	Price gr. A217 (m ²)	
				554035-32020H	554035-38110H	554035-32050H¹	medium stone grey
				Price gr. A217 (m ²)	Price gr. A199 (m ²)	Price gr. A217 (m ²)	
				554036-32020H	554036-38110H	554036-32050H¹	dark stone grey
				Price gr. A217 (m ²)	Price gr. A199 (m ²)	Price gr. A217 (m ²)	
				554038-32020H	554038-38110H	554038-32050H	light sand-grey
				Price gr. A217 (m ²)	Price gr. A199 (m ²)	Price gr. A217 (m ²)	
				554039-32020H	554039-38110H	554039-32050H¹	medium sand-grey
				Price gr. A217 (m ²)	Price gr. A199 (m ²)	Price gr. A217 (m ²)	
				554040-32020H	554040-38110H	554040-32050H¹	dark sand-grey
				Price gr. A217 (m ²)	Price gr. A199 (m ²)	Price gr. A217 (m ²)	
				554119-32020H¹	554119-38110H	554119-32050H¹	neutral 9
				Price gr. A217 (m ²)	Price gr. A199 (m ²)	Price gr. A217 (m ²)	(white grey)
				554118-32020H	554118-38110H	554118-32050H¹	neutral 8
				Price gr. A217 (m ²)	Price gr. A199 (m ²)	Price gr. A217 (m ²)	(light-grey)
				554117-32020H	554117-38110H	554117-32050H	neutral 7
				Price gr. A217 (m ²)	Price gr. A199 (m ²)	Price gr. A217 (m ²)	(pebble grey)
				554113-32020H	554113-38110H	554113-32050H	neutral 3
				Price gr. A217 (m ²)	Price gr. A199 (m ²)	Price gr. A217 (m ²)	(asphalt black)
				78i-32020H	78i-38110H	78i-32050H¹	contrasting red
				Price gr. A217 (m ²)	Price gr. A199 (m ²)	Price gr. A217 (m ²)	

¹ Make-to-order production: return and/or cancellation of ordered products not possible.

² Rounded edges / corners refer to page 132
³ Supplied as double-tiles; to be broken by customer.



All products: Color Shade Variation V0

Slip resistance „C“ – rounded edges / corners^{1/2}

Floor Tiles

12.5 x 12.5 cm 12.5 x 12.5 cm 12.5 x 25 cm 12.5 x 25 cm 12.5 x 25 cm 12.5 x 25 cm



rounded edge rounded corner short side rounded long side rounded rounded corner left rounded corner right

Model number	32025H	32027H	38115H	38116H	38117H	38118H
Nom. dim. - cm/in	12.5 x 12.5 / 5 x 5	12.5 x 12.5 / 5 x 5	12.5 x 25 / 5 x 10	12.5 x 25 / 5 x 10	12.5 x 25 / 5 x 10	12.5 x 25 / 5 x 10
Work size	119 x 119 x 8 mm	119 x 119 x 8 mm	119 x 244 x 8 mm	119 x 244 x 8 mm	119 x 244 x 8 mm	119 x 244 x 8 mm
Surface	structured, silky-matt	structured, silky-matt	structured, silky-matt	structured, silky-matt	structured, silky-matt	structured, silky-matt
m ² - pieces						
pieces - kg	0.240	0.240	0.490	0.490	0.490	0.490
Bundle - pieces	66	66	33	33	33	33
Bundle - m ²						
Bundle - kg	15.840	15.840	16.170	16.170	16.170	16.170
Pallet - m ²						
Pallet - kg						
Product standard	Alb	Alb	Alb	Alb	Alb	Alb
Slip resistance	-/C ☒	-/C ☒	-/C ☒	-/C ☒	-/C ☒	-/C ☒
Stress group	2	2	2	2	2	2
neutral 10	81i-32025H	81i-32027H	81i-38115H	81i-38116H	81i-38117H	81i-38118H
(active white)	Price gr. A410 (pce.)	Price gr. A410 (pce.)	Price gr. A416 (pce.)	Price gr. A416 (pce.)	Price gr. A416 (pce.)	Price gr. A416 (pce.)
neutral 1	554111-32025H	554111-32027H	554111-38115H	554111-38116H	554111-38117H	554111-38118H
(deep black)	Price gr. A410 (pce.)	Price gr. A410 (pce.)	Price gr. A416 (pce.)	Price gr. A416 (pce.)	Price gr. A416 (pce.)	Price gr. A416 (pce.)
	554001-32025H	554001-32027H	554001-38115H	554001-38116H	554001-38117H	554001-38118H
active azure	Price gr. A410 (pce.)	Price gr. A410 (pce.)	Price gr. A416 (pce.)	Price gr. A416 (pce.)	Price gr. A416 (pce.)	Price gr. A416 (pce.)
	554002-32025H	554002-32027H	554002-38115H	554002-38116H	554002-38117H	554002-38118H
light azure	Price gr. A410 (pce.)	Price gr. A410 (pce.)	Price gr. A416 (pce.)	Price gr. A416 (pce.)	Price gr. A416 (pce.)	Price gr. A416 (pce.)



25 x 25 cm 25 x 25 cm



rounded edge rounded corner

Model number	32055H	32057H				
Nom. dim. - cm/in	25 x 25 / 10 x 10	25 x 25 / 10 x 10				
Work size	244 x 244 x 8 mm	244 x 244 x 8 mm				
Surface	structured, silky-matt	structured, silky-matt				
m ² - pieces						
pieces - kg	1.060	1.060				
Bundle - pieces	14	14				
Bundle - m ²						
Bundle - kg	14.840	14.840				
Pallet - m ²						
Pallet - kg						
Product standard	Alb	Alb				
Slip resistance	-/C ☒	-/C ☒				
Stress group	2	2				
neutral 10	81i-32055H	81i-32057H				
(active white)	Price gr. A434 (pce.)	Price gr. A434 (pce.)				
neutral 1	554111-32055H	554111-32057H				
(deep black)	Price gr. A434 (pce.)	Price gr. A434 (pce.)				
	554001-32055H	554001-32057H				
active azure	Price gr. A434 (pce.)	Price gr. A434 (pce.)				
	554002-32055H	554002-32057H				
light azure	Price gr. A434 (pce.)	Price gr. A434 (pce.)				



¹ Other colors available on request.

² Make-to-order production: return and/or cancellation of ordered products not possible.



All products: Color Shade Variation V0



Rounded edges

Replace last figure 0 of Standard model no. by 7 = corner left	... 8 = corner right	overglazed edges	Example: Standard model no. 38110 = 119 x 244 x 6 mm, model no. 38117 = rounded corner left
--	---------------------	----------------------	------------------	---



Project: Oasia Hotel / Location: Singapore / Architect: WOHA Architects + Patricia Urquiola / Series: Chroma non-slip, Chroma / Photo: Infitude





Project: Bybadet / Location: Alesund, Norwegen / Architect: Invit Arkitekter AS /
Series: Chroma / Photo: Tove Lauluten







R10/A R10/B R11/B



Quantum



926
white / neutral 10 (active white)



555023
medium ochre

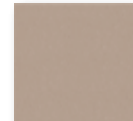

Floor/wall tile
12.5 x 12.5 cm, 5 x 5 in, smooth, R10/A



555118
neutral 8 (light-grey)



555036
dark stone grey



555035
medium stone grey

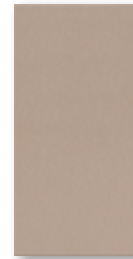

Floor/wall tile
12.5 x 25 cm, 5 x 10 in, smooth, R10/A



555117
neutral 7 (pebble-grey)



555040
dark sand grey



555039
medium sand grey



555038
light sand grey



555113
neutral 3 (asphalt black)



918
black / neutral 1 (deep black)

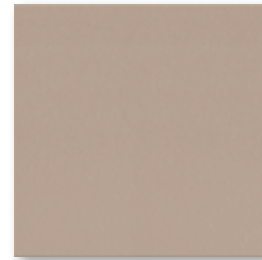

Floor/wall tile
25 x 25 cm, 10 x 10 in, smooth, R10/A

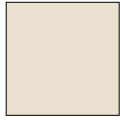

901
natural-white

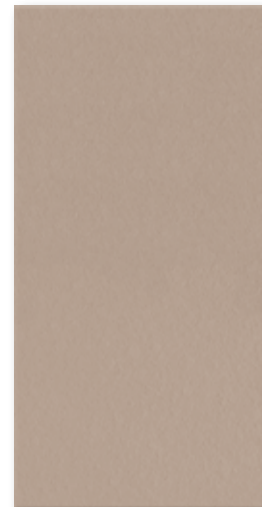

Floor/wall tile
25 x 50 cm, 10 x 20 in, smooth, R10/A

Grid profile

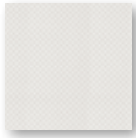

Grid profile tile
12.5 x 12.5 cm, 5 x 5 in, relief, R11/B

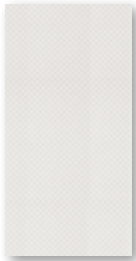

Grid profile tile
12.5 x 25 cm, 5 x 10 in, relief, R11/B

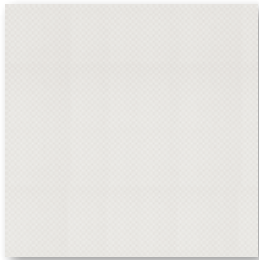

Grid profile tile
25 x 25 cm, 10 x 10 in, relief, R11/B

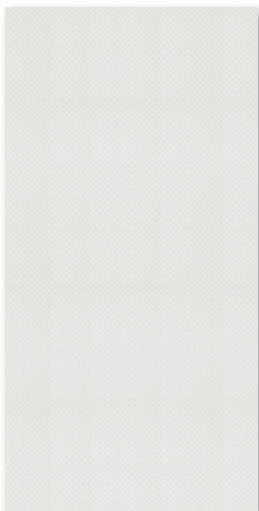

Grid profile tile
25 x 50 cm, 10 x 20 in, relief, R11/B

Shower Tub System

Shower tub system
Corner (one piece)
12.5 x 12.5 cm, 5 x 5 in, smooth, R10/B



Shower tub system
Strip
12.5 x 12.5 cm, 5 x 5 in
smooth, R10/B

Shower tub system
Strip
25 x 12.5 cm, 10 x 5 in
smooth, R10/B

Cove skirting, r = 12 mm
25 x 12.5 cm, 10 x 5 in, smooth



External angle,
smooth

Internal angle,
smooth

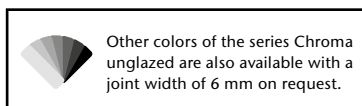

Other colors of the series Chroma unglazed are also available with a joint width of 6 mm on request.

Quantum

Floor/Wall Tiles

12.5 x 12.5 cm³



12.5 x 25 cm



25 x 25 cm



25 x 50 cm^{1/2}

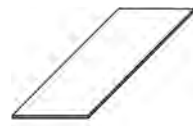

Model number	32020H	38110H	32050H	42550HK			
Nom. dim. - cm/in	12.5 x 12.5 / 5 x 5	12.5 x 25 / 5 x 10	25 x 25 / 10 x 10	25 x 50 / 10 x 20			
Work size	119 x 119 x 8 mm	119 x 244 x 8 mm	244 x 244 x 8 mm	244 x 494 x 8 mm			
Surface	smooth, silky-matt	smooth, silky-matt	smooth, silky-matt	smooth, silky-matt			
m ² - pieces	64.000	32.000	16.000	8.000			
m ² - kg	15.360	15.680	16.960	17.040			
Bundle - pieces	66	33	14	9			
Bundle - m ²	1.031	1.031	0.875	1.125			
Bundle - kg	15.840	16.170	14.840	19.170			
Pallet - m ²	86.625	86.625	70.875	40.500			
Pallet - kg	1,330.560	1,358.280	1,202.040	690.120			
Product standard	Alb	Alb	Alb	Alb			
Slip resistance	R10/A	R10/A	R10/A	R10/A			
Stress group	2	2	2	2			
neutral 10 (active white)	926i-32020H Price gr. A166 (m ²)	926i-38110H Price gr. A166 (m ²)	926i-32050H Price gr. A166 (m ²)	926i-42550HK Price gr. A178 (m ²)			
neutral 1 (deep black)	918i-32020H Price gr. A166 (m ²)	918i-38110H Price gr. A166 (m ²)	918i-32050H Price gr. A166 (m ²)	918i-42550HK Price gr. A178 (m ²)			
medium ochre	555023-32020H¹ Price gr. A166 (m ²)	555023-38110H¹ Price gr. A166 (m ²)	555023-32050H¹ Price gr. A166 (m ²)	555023-42550HK Price gr. A178 (m ²)			
medium stone grey	555035-32020H¹ Price gr. A166 (m ²)	555035-38110H¹ Price gr. A166 (m ²)	555035-32050H¹ Price gr. A166 (m ²)	555035-42550HK Price gr. A178 (m ²)			
dark stone grey	555036-32020H¹ Price gr. A166 (m ²)	555036-38110H¹ Price gr. A166 (m ²)	555036-32050H¹ Price gr. A166 (m ²)	555036-42550HK Price gr. A178 (m ²)			
light sand-grey	555038-32020H¹ Price gr. A166 (m ²)	555038-38110H¹ Price gr. A166 (m ²)	555038-32050H¹ Price gr. A166 (m ²)	555038-42550HK Price gr. A178 (m ²)			
medium sand-grey	555039-32020H¹ Price gr. A166 (m ²)	555039-38110H¹ Price gr. A166 (m ²)	555039-32050H¹ Price gr. A166 (m ²)	555039-42550HK Price gr. A178 (m ²)			
dark sand-grey	555040-32020H¹ Price gr. A166 (m ²)	555040-38110H¹ Price gr. A166 (m ²)	555040-32050H¹ Price gr. A166 (m ²)	555040-42550HK Price gr. A178 (m ²)			
neutral 3 (asphalt black)	555113-32020H¹ Price gr. A166 (m ²)	555113-38110H¹ Price gr. A166 (m ²)	555113-32050H¹ Price gr. A166 (m ²)	555113-42550HK Price gr. A178 (m ²)			
neutral 7 (pebble grey)	555117-32020H¹ Price gr. A166 (m ²)	555117-38110H¹ Price gr. A166 (m ²)	555117-32050H¹ Price gr. A166 (m ²)	555117-42550HK Price gr. A178 (m ²)			
neutral 8 (light-grey)	555118-32020H¹ Price gr. A166 (m ²)	555118-38110H¹ Price gr. A166 (m ²)	555118-32050H¹ Price gr. A166 (m ²)	555118-42550HK Price gr. A178 (m ²)			
natural-white	901i-32020H Price gr. A166 (m ²)	901i-38110H Price gr. A166 (m ²)	901i-32050H Price gr. A166 (m ²)	901i-42550HK Price gr. A178 (m ²)			



¹  Make-to-order production: return and/or cancellation of ordered products not possible. Minimum order quantity: 200 m²

²  rectified

³ Supplied as double-tiles; to be broken by customer.

All products: Color Shade Variation V0

Quantum

Floor Tiles

12.5 x 12.5 cm³



12.5 x 25 cm



25 x 25 cm



25 x 50 cm^{1/2}



			Grid profile tile	Grid profile tile	Grid profile tile	Grid profile tile	
			32100H	34090H	32080H	42580HK	Model number
			12.5 x 12.5 / 5 x 5	12.5 x 25 / 5 x 10	25 x 25 / 10 x 10	25 x 50 / 10 x 20	Nom. dim. - cm/in
			119 x 119 x 8 mm	119 x 244 x 8 mm	244 x 244 x 8 mm	244 x 494 x 8 mm	Work size
			relief, silky-matt	relief, silky-matt	relief, silky-matt	relief, silky-matt	Surface
			64.000	32.000	16.000	8.000	m ² - pieces
			15.360	15.360	16.800	17.040	m ² - kg
			66	33	14	9	Bundle - pieces
			1.031	1.031	0.875	1.125	Bundle - m ²
			15.840	15.840	14.700	19.170	Bundle - kg
			86.625	86.625	70.875	40.500	Pallet - m ²
			1,330.560	1,330.560	1,190.700	690.120	Pallet - kg
			Alb	Alb	Alb	Alb	Product standard
			R11/B	R11/B	R11/B	R11/B	Slip resistance
			2	2	2	2	Stress group
			926i-32100H	926i-34090H	926i-32080H	926i-42580HK	neutral 10
			Price gr. A178 (m ²)	Price gr. A178 (m ²)	Price gr. A178 (m ²)	Price gr. A196 (m ²)	(active white)
			918i-32100H	918i-34090H	918i-32080H	918i-42580HK	neutral 1
			Price gr. A178 (m ²)	Price gr. A178 (m ²)	Price gr. A178 (m ²)	Price gr. A196 (m ²)	(deep black)
			555023-32100H¹	555023-34090H¹	555023-32080H¹	555023-42580HK	
			Price gr. A178 (m ²)	Price gr. A178 (m ²)	Price gr. A178 (m ²)	Price gr. A196 (m ²)	medium ochre
			555035-32100H¹	555035-34090H¹	555035-32080H¹	555035-42580HK	
			Price gr. A178 (m ²)	Price gr. A178 (m ²)	Price gr. A178 (m ²)	Price gr. A196 (m ²)	medium stone grey
			555036-32100H¹	555036-34090H¹	555036-32080H¹	555036-42580HK	
			Price gr. A178 (m ²)	Price gr. A178 (m ²)	Price gr. A178 (m ²)	Price gr. A196 (m ²)	dark stone grey
			555038-32100H¹	555038-34090H¹	555038-32080H¹	555038-42580HK	
			Price gr. A178 (m ²)	Price gr. A178 (m ²)	Price gr. A178 (m ²)	Price gr. A196 (m ²)	light sand-grey
			555039-32100H¹	555039-34090H¹	555039-32080H¹	555039-42580HK	
			Price gr. A178 (m ²)	Price gr. A178 (m ²)	Price gr. A178 (m ²)	Price gr. A196 (m ²)	medium sand-grey
			555040-32100H¹	555040-34090H¹	555040-32080H¹	555040-42580HK	
			Price gr. A178 (m ²)	Price gr. A178 (m ²)	Price gr. A178 (m ²)	Price gr. A196 (m ²)	dark sand-grey
			555113-32100H¹	555113-34090H¹	555113-32080H¹	555113-42580HK	neutral 3
			Price gr. A178 (m ²)	Price gr. A178 (m ²)	Price gr. A178 (m ²)	Price gr. A196 (m ²)	(asphalt black)
			555117-32100H¹	555117-34090H¹	555117-32080H¹	555117-42580HK	neutral 7
			Price gr. A178 (m ²)	Price gr. A178 (m ²)	Price gr. A178 (m ²)	Price gr. A196 (m ²)	(pebble grey)
			555118-32100H¹	555118-34090H¹	555118-32080H¹	555118-42580HK	neutral 8
			Price gr. A178 (m ²)	Price gr. A178 (m ²)	Price gr. A178 (m ²)	Price gr. A196 (m ²)	(light-grey)
			901i-32100H	901i-34090H	901i-32080H	901i-42580HK	natural-white
			Price gr. A178 (m ²)	Price gr. A178 (m ²)	Price gr. A178 (m ²)	Price gr. A196 (m ²)	

¹ Make-to-order production: return and/or cancellation of ordered products not possible.
Minimum order quantity: 200 m²

² rectified

³ Supplied as double-tiles; to be broken by customer.

All products: Color Shade Variation V0



Quantum

Shower Tub System¹

12.5 x 25 cm



12.5 x 12.5 cm



12.5 x 12.5 cm



Lip 10 mm

Lip 10 mm



Strip

Strip

Ecke

Model number	27182H	27180H	27181H
Nom. dim. - cm/in	12.5 x 25 / 5 x 10	12.5 x 12.5 / 5 x 5	12.5 x 12.5 / 5 x 5
Work size	119 x 244 x 18/8 mm	119 x 119 x 18/8 mm	119 x 119 x 18/8 mm
Surface	smooth, silky-matt	smooth, silky-matt	smooth, silky-matt
m - pieces	4.000	8.000	
m/pce. - kg	2.720/m	2.720/m	0.500/pieces
Bundle - pieces	22	44	12
Bundle - m	5.500	5.500	
Bundle - kg	14.960	14.960	6.000
Pallet - m			
Pallet - kg			
Product standard	Alb	Alb	Alb
Slip resistance	R10/B	R10/B	R10/B
neutral 10	926i-27182H	926i-27180H	926i-27181H
(active white)	Price gr. A506 (pce.)	Price gr. A455 (pce.)	Price gr. A489 (pce.)
neutral 1	918i-27182H	918i-27180H	918i-27181H
(deep black)	Price gr. A506 (pce.)	Price gr. A455 (pce.)	Price gr. A489 (pce.)
medium ochre	555023-27182H ²	555023-27180H ²	555023-27181H ²
	Price gr. A506 (pce.)	Price gr. A455 (pce.)	Price gr. A489 (pce.)
medium stone grey	555035-27182H ²	555035-27180H ²	555035-27181H ²
	Price gr. A506 (pce.)	Price gr. A455 (pce.)	Price gr. A489 (pce.)
dark stone grey	555036-27182H ²	555036-27180H ²	555036-27181H ²
	Price gr. A506 (pce.)	Price gr. A455 (pce.)	Price gr. A489 (pce.)
light sand-grey	555038-27182H ²	555038-27180H ²	555038-27181H ²
	Price gr. A506 (pce.)	Price gr. A455 (pce.)	Price gr. A489 (pce.)
medium sand-grey	555039-27182H ²	555039-27180H ²	555039-27181H ²
	Price gr. A506 (pce.)	Price gr. A455 (pce.)	Price gr. A489 (pce.)
dark sand-grey	555040-27182H ²	555040-27180H ²	555040-27181H ²
	Price gr. A506 (pce.)	Price gr. A455 (pce.)	Price gr. A489 (pce.)
neutral 3	555113-27182H ²	555113-27180H ²	555113-27181H ²
(asphalt black)	Price gr. A506 (pce.)	Price gr. A455 (pce.)	Price gr. A489 (pce.)
neutral 7	555117-27182H ²	555117-27180H ²	555117-27181H ²
(pebble grey)	Price gr. A506 (pce.)	Price gr. A455 (pce.)	Price gr. A489 (pce.)
neutral 8	555118-27182H ²	555118-27180H ²	555118-27181H ²
(light-grey)	Price gr. A506 (pce.)	Price gr. A455 (pce.)	Price gr. A489 (pce.)
natural-white	901i-27182H	901i-27180H	901i-27181H
	Price gr. A506 (pce.)	Price gr. A455 (pce.)	Price gr. A489 (pce.)



¹ For details, refer to page 715

²  Make-to-order production: return and/or cancellation of ordered products not possible.

All products: Color Shade Variation V0

Quantum

Safety Strip Tile^{1/2}

6.2 x 25 cm



rounded long edge

Skirtings²

7.9 x 25 cm



Skirting

12.5 x 25 cm³



*Cove skirting,
r = 12 mm*



*External Corner
mitred pair*



*Internal Corner
mitred pair*

	<i>rounded long edge</i>	<i>Skirting</i>	<i>Cove skirting, r = 12 mm</i>	<i>External Corner mitred pair</i>	<i>Internal Corner mitred pair</i>	
	34306H	34020H	37080	37081	37082	Model number
	6.2 x 25 / 2 1/2 x 10	7.9 x 25 / 3 1/8 x 10	12.5 x 25 / 5 x 10			Nom. dim. - cm/in
	56 x 244 x 8 mm	73 x 244 x 8 mm	125 x 244/12 x 8 mm	(2x) 131 x 125/12 x 8 mm	(2x) 119 x 125/12 x 8 mm	Work size
	grooved, silky-matt	smooth, silky-matt	smooth, silky-matt	smooth, silky-matt	smooth, silky-matt	Surface
	4.000	4.000	4.000			m - pieces
	0.800/m	1.160/m	2.520/m	0.600/pair	0.400/pair	m/pair - kg
	66 pieces	33 pieces	20 pieces	10 pairs	10 pairs	Bundle - pce./pair
	16.500	8.250	5.000			Bundle - m
	13.200	9.570	12.600	6.000	4.000	Bundle - kg
						Pallet - m
						Pallet - kg
	Alb	Alb	Alb	Alb	Alb	Product standard
	-/C					Slip resistance
		926i-34020H	926-37080	926-37081	926-37082	neutral 10
		Price gr. A410 (pce.)	Price gr. A423 (pce.)	Price gr. A455 (pair)	Price gr. A455 (pair)	(active white)
	918i-34306H	918i-34020H	918-37080	918-37081	918-37082	neutral 1
	Price gr. A434 (pce.)	Price gr. A410 (pce.)	Price gr. A423 (pce.)	Price gr. A455 (pair)	Price gr. A455 (pair)	(deep black)
		901i-34020H	901-37080	901-37081	901-37082	
		Price gr. A410 (pce.)	Price gr. A423 (pce.)	Price gr. A455 (pair)	Price gr. A455 (pair)	natural-white

¹ Especially suitable for non-slip and clearly visible (stair) edge design.

² Other colors available on request.

³ The cove skirtings comply with DIN EN 14411, group Al_b, glazed (GL)

All products: Color Shade Variation V0



Project: Bar Bardem / Location: Helsinki, Finland / Architect: Fyra Ltd. / Series: Craft / Photo: Riikka Kantinkoski



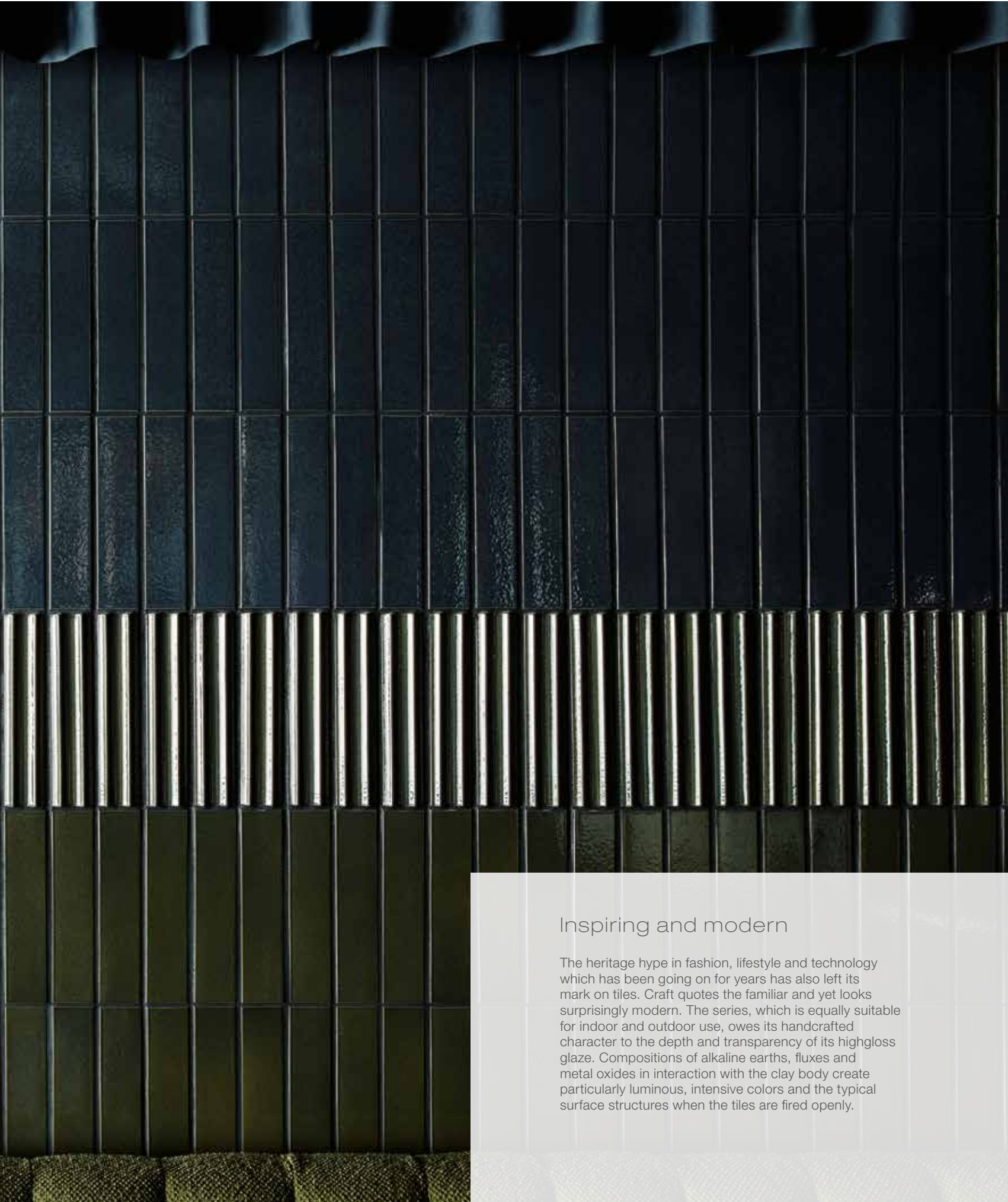

Inspiring and modern

The heritage hype in fashion, lifestyle and technology which has been going on for years has also left its mark on tiles. Craft quotes the familiar and yet looks surprisingly modern. The series, which is equally suitable for indoor and outdoor use, owes its handcrafted character to the depth and transparency of its highgloss glaze. Compositions of alkaline earths, fluxes and metal oxides in interaction with the clay body create particularly luminous, intensive colors and the typical surface structures when the tiles are fired openly.

Mono-colors Flamed colors

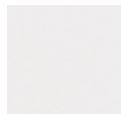

pure white



white



mid-grey



dark-grey



jade-green



beryl-red



benit-blue

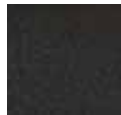

hematite-black



olive-green flamed



golden-yellow flamed



amber flamed



blue-green flamed

Natural Ceramics colors



golden ochre



golden cream



golden grey



golden black

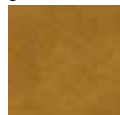

tobacco



Strip tile 8.3 x 25 cm, 3 5/16 x 10 in, hammered



Strip tile 6.2 x 25 cm, 2 1/2 x 10 in, smooth



Strip tile, wave profile 6.2 x 25 cm, eben



Strip tile, grooved profile 6.2 x 25 cm, 2 1/2 x 10 in, smooth

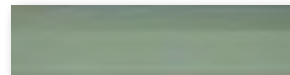

Strip tile, V-pointed profile 6.2 x 25 cm, 2 1/2 x 10 in, smooth



Double-tip tile 12.5 x 25 cm, 5 x 10 in, smooth



Cover tile drip edge 25 x 30 cm, 10 x 12 in, smooth



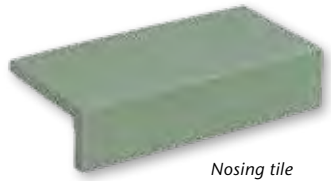

Nosing tile
12.5 x 25 cm, 5 x 10 in, smooth

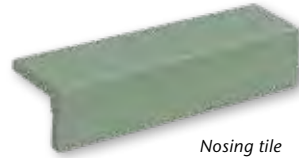

Nosing tile
6.2 x 25 cm, 2 x 10 in, smooth



Corner piece
6.2 x 12.5 / 6.2 x 1.1 cm,
2 x 5 in / 2 x 0.44 in, smooth

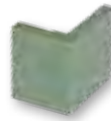

Corner piece
6.2 x 6.2 / 6.2 x 1.1 cm,
2 x 2 in / 2 x 0.44 in, smooth



Strip tile 6.2 x 25 cm, 2 1/2 x 10 in



Strip tile, wave profile 6.2 x 25 cm, 2 1/2 x 10 in



Double-tip strip tile 12.5 x 25 cm, 5 x 10 in



Strip tile, V-pointed profile 6.2 x 25 cm, 2 1/2 x 10 in



Strip tile, grooved profile 6.2 x 25 cm, 2 1/2 x 10 in

Strip Tile³

Double-Tip Tile

8.3 x 25 cm^{1/2}



6.2 x 25 cm²



6.2 x 25 cm²



6.2 x 25 cm^{2/6}



6.2 x 25 cm²



12.5 x 25 cm



Wave profile

V-pointed profile, nonsymmetrical

Grooved profile (A&B side)

	2110	2120	2250	2270	2280	2240	Model number
	8.3 x 25 / 3 5/16 x 10	6.2 x 25 / 2 1/2 x 10	6.2 x 25 / 2 1/2 x 10	6.2 x 25 / 2 1/2 x 10	6.2 x 25 / 2 1/2 x 10	12.5 x 25 / 5 x 10	Nom. dim. - cm/in
	73 x 240 x 11 mm	52 x 240 x 11 mm	52 x 240 x 16/11 mm	52 x 240 x 18/11 mm	52 x 240 x 11 mm	115 x 240 x 20/11 mm	Work size
	hammered, matt ⁴	smooth, glossy ⁴	smooth, glossy	smooth, glossy	smooth, glossy	smooth, glossy	Surface
	50.000	67.000	67.000	67.000	67.000	33.000	m ² - pieces
	22.500	20.100	21.775	27.470	21.440	27.060	m ² - kg
	40	48	36	30	44	14	Bundle - pieces
	0.800	0.716	0.537	0.448	0.656	0.424	Bundle - m ²
	18.000	14.400	11.700	12.300	14.080	11.480	Bundle - kg
	48.000	51.582	41.910	32.239	47.283	30.545	Pallet - m ²
	1,080.000	1,036.800	912.600	885.600	1,013.760	826.560	Pallet - kg
	Alla	Alla	Alla	Alla	Alla	Alla	Product standard
	see below						Slip resistance
	2						Stress group
		9027-2120	9027-2250	9027-2270	9027-2280	9027-2240	
		Price gr. A157 (m ²)	Price gr. A334 (m ²)	Price gr. A334 (m ²)	Price gr. A334 (m ²)	Price gr. A355 (m ²)	pure white
		9026-2120	9026-2250	9026-2270	9026-2280	9026-2240	
		Price gr. A157 (m ²)	Price gr. A334 (m ²)	Price gr. A334 (m ²)	Price gr. A334 (m ²)	Price gr. A355 (m ²)	white
		9022-2120	9022-2250	9022-2270	9022-2280	9022-2240	
		Price gr. A157 (m ²)	Price gr. A334 (m ²)	Price gr. A334 (m ²)	Price gr. A334 (m ²)	Price gr. A355 (m ²)	medium grey
		9021-2120	9021-2250¹	9021-2270¹	9021-2280¹	9021-2240¹	
		Price gr. A157 (m ²)	Price gr. A334 (m ²)	Price gr. A334 (m ²)	Price gr. A334 (m ²)	Price gr. A355 (m ²)	dark-grey
		9020-2120	9020-2250	9020-2270	9020-2280	9020-2240	
		Price gr. A157 (m ²)	Price gr. A334 (m ²)	Price gr. A334 (m ²)	Price gr. A334 (m ²)	Price gr. A355 (m ²)	olive-green
		9023-2120	9023-2250¹	9023-2270¹	9023-2280¹	9023-2240¹	
		Price gr. A157 (m ²)	Price gr. A334 (m ²)	Price gr. A334 (m ²)	Price gr. A334 (m ²)	Price gr. A355 (m ²)	flamed
		9025-2120	9025-2250	9025-2270	9025-2280	9025-2240	
		Price gr. A157 (m ²)	Price gr. A334 (m ²)	Price gr. A334 (m ²)	Price gr. A334 (m ²)	Price gr. A355 (m ²)	golden-yellow
		9024-2120	9024-2250	9024-2270	9024-2280	9024-2240	
		Price gr. A157 (m ²)	Price gr. A334 (m ²)	Price gr. A334 (m ²)	Price gr. A334 (m ²)	Price gr. A355 (m ²)	flamed
		9030-2120	9030-2250	9030-2270	9030-2280	9030-2240	
		Price gr. A157 (m ²)	Price gr. A334 (m ²)	Price gr. A334 (m ²)	Price gr. A334 (m ²)	Price gr. A355 (m ²)	amber
		9031-2120	9031-2250¹	9031-2270¹	9031-2280¹	9031-2240¹	
		Price gr. A157 (m ²)	Price gr. A334 (m ²)	Price gr. A334 (m ²)	Price gr. A334 (m ²)	Price gr. A355 (m ²)	flamed
		9032-2120	9032-2250¹	9032-2270¹	9032-2280¹	9032-2240¹	
		Price gr. A157 (m ²)	Price gr. A334 (m ²)	Price gr. A334 (m ²)	Price gr. A334 (m ²)	Price gr. A355 (m ²)	blue-green
		9033-2120	9033-2250¹	9033-2270¹	9033-2280¹	9033-2240¹	
		Price gr. A157 (m ²)	Price gr. A334 (m ²)	Price gr. A334 (m ²)	Price gr. A334 (m ²)	Price gr. A355 (m ²)	flamed
	951-2110	951-2120¹					
	Price gr. A136 (m ²)	Price gr. A127 (m ²)					jade-green
	R11/A						
	851-2110⁵						
	Price gr. A136 (m ²)						beryl-red
	R11/A						
	854-2110⁵						
	Price gr. A136 (m ²)						benit-blue
	R11/A						
	855-2110⁵						
	Price gr. A136 (m ²)						hematite-black
	R11/A						
	856-2110⁵						
	Price gr. A136 (m ²)						tobacco
							golden ochre
							golden cream
							golden grey
							golden black

¹ Make-to-order production: return and/or cancellation of ordered products not possible.

² Supplied as double-tiles; to be broken by customer.

³ Color Shade Variation

V1: pure white, white, medium grey, dark-grey, jade-green, berylred, benit-blue, hematite-black

V2: olive-green flamed, amber flamed, golden cream, golden grey, golden black

V3: golden-yellow flamed, blue-green flamed

V4: tobacco, golden ochre

⁴ Exception: tobacco: smooth, silky-matt

⁵ Exception: complies with DIN EN 14411, group Alla - part 1, unglazed (UGL)

⁶ For format 2270: Due to manufacturing reasons, right and left overglazed short edges are generated at a ratio of 1:1 in the case of this article, which have to be purchased by the customer. Only one longitudinal edge can be glazed.

For the series Craft:

Minimum order quantity in the case of the colors specified above: 250 m²

Minimum order quantity in the case of special colors: 500 m²

Price for lower quantities on request.

The customer agrees to purchase a possible overproduction of 10 %.

Overglazed edge(s) possible up to max. 10% of the order quantity. A separate order is necessary.



Cover Tile^{1/2}

Nosing Tiles^{1/2}

Corner Pieces^{1/2}

25 x 30 cm



12.5 x 25 cm



6.2 x 25 cm



Drip edge

Model number	9220	4822	2521	2721	2720		
Nom. dim. - cm/in	25 x 30 / 10 x 12	12.5 x 25 / 5 x 10	6.2 x 25 / 2 1/2 x 10				
Work size	240 x 300 x 20 mm	115/52 x 240 x 11 mm	52/52 x 240 x 11 mm	115/52 x 52 x 11 mm	52/52 x 52 x 11 mm		
Surface	smooth, glossy	smooth, glossy	smooth, glossy	smooth, glossy	smooth, glossy		
m - pieces	4.000	4.000	4.000				
m/pce. - kg	12.124/m	3.880/m	2.240/m	0.204/pieces	0.122/pieces		
Bundle - pieces	7	8	16	15	40		
Bundle - m	1.750	2.000	4.000				
Bundle - kg	21.217	7.760	8.960	3.060	4.880		
Pallet - m							
Pallet - kg							
Product standard	Alla	Alla	Alla	Alla	Alla		
	9027-9220	9027-4822	9027-2521	9027-2721	9027-2720		
pure white	Price gr. A471 (pce.)	Price gr. A458 (pce.)	Price gr. A458 (pce.)	Price gr. A428 (pce.)	Price gr. A428 (pce.)		
	9026-9220	9026-4822	9026-2521	9026-2721	9026-2720		
white	Price gr. A471 (pce.)	Price gr. A458 (pce.)	Price gr. A458 (pce.)	Price gr. A428 (pce.)	Price gr. A428 (pce.)		
	9022-9220	9022-4822	9022-2521	9022-2721	9022-2720		
medium grey	Price gr. A471 (pce.)	Price gr. A458 (pce.)	Price gr. A458 (pce.)	Price gr. A428 (pce.)	Price gr. A428 (pce.)		
	9021-9220	9021-4822	9021-2521	9021-2721	9021-2720		
dark-grey	Price gr. A471 (pce.)	Price gr. A458 (pce.)	Price gr. A458 (pce.)	Price gr. A428 (pce.)	Price gr. A428 (pce.)		
	9020-9220						
olive-green flamed	Price gr. A471 (pce.)						
	9023-9220						
golden-yellow flamed	Price gr. A471 (pce.)						
	9025-9220						
amber flamed	Price gr. A471 (pce.)						
	9024-9220						
blue-green flamed	Price gr. A471 (pce.)						
	9030-9220	9030-4822	9030-2521	9030-2721	9030-2720		
jade-green	Price gr. A471 (pce.)	Price gr. A458 (pce.)	Price gr. A458 (pce.)	Price gr. A428 (pce.)	Price gr. A428 (pce.)		
	9031-9220	9031-4822	9031-2521	9031-2721	9031-2720		
beryl-red	Price gr. A471 (pce.)	Price gr. A458 (pce.)	Price gr. A458 (pce.)	Price gr. A428 (pce.)	Price gr. A428 (pce.)		
	9032-9220	9032-4822	9032-2521	9032-2721	9032-2720		
benit-blue	Price gr. A471 (pce.)	Price gr. A458 (pce.)	Price gr. A458 (pce.)	Price gr. A428 (pce.)	Price gr. A428 (pce.)		
	9033-9220	9033-4822	9033-2521	9033-2721	9033-2720		
hematite-black	Price gr. A471 (pce.)	Price gr. A458 (pce.)	Price gr. A458 (pce.)	Price gr. A428 (pce.)	Price gr. A428 (pce.)		



¹ Make-to-order production: return and/or cancellation of ordered products not possible. Minimum order quantity on request.

² Color Shade Variation
 V1: pure white, white, medium grey, dark-grey, jade-green, beryl-red, benit-blue, hematite-black
 V2: olive-green flamed, amber flamed
 V3: golden-yellow flamed, blue-green flamed

Project: Restaurant OCTAVE / Location: Antwerpen, Belgium / Architect: real.space agency Antwerpen, Belgium / Series: Craft / Photo: Marcel van der Burg, Amsterdam



Project: Residential quarter Bellaria / Location: Zurich-Wollishofen, Switzerland /
Architect: Michael Meier und Marius Hug Architekten AG, Zurich, Switzerland / Series: Craft Extended / Photo: Adriano Faragulo

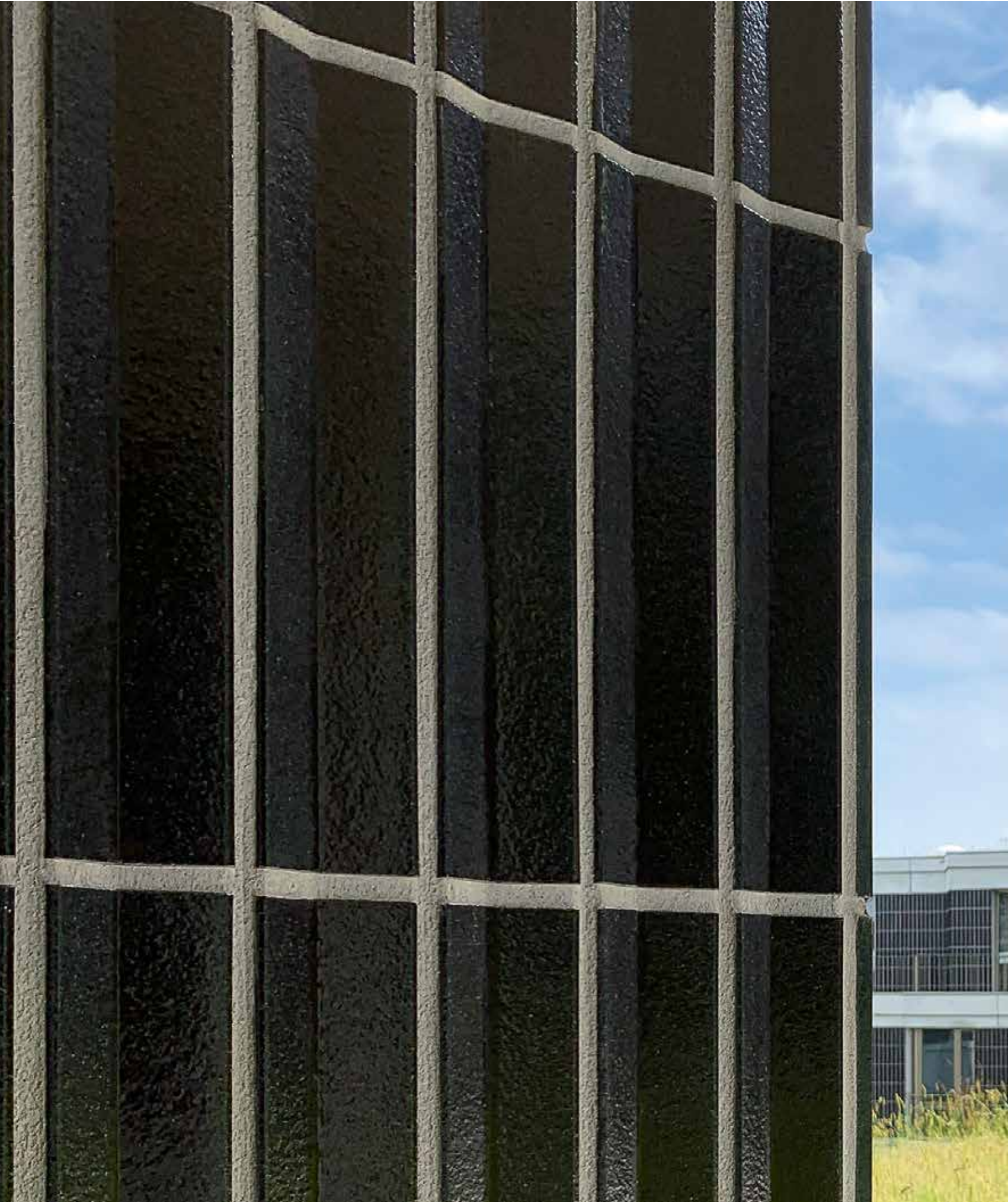



Mono-colors

Flamed colors



lime-white



natural-white



pearl-grey



natural-grey



reseda-green



crimson



cobalt-blue



deep black



reed-green flamed



red-brown flamed



petrol-blue flamed



Long strip tile 6.2 x 50 cm, 2 1/2 x 20 in, smooth



Long strip tile, V-pointed profile, symmetrical 6.2 x 50 cm, 2 1/2 x 20 in, smooth



Cover tile, drip edge, 31 x 30 cm, 12 13/64 x 12 in, smooth



6.2 x 50 cm²



6.2 x 50 cm²



31 x 30 cm^{1/2}



Long strip tile, V-pointed
profile, symmetrical

Cover tile, drip edge

	Strip Tile	Long strip tile, V-pointed profile, symmetrical	Cover tile, drip edge	
	2320	2290	9215	Model number
	6.2 x 50 / 2 1/2 x 20	6.2 x 50 / 2 1/2 x 20	31 x 30 / 12 13/64 x 12	Nom. dim. - cm/in
	52 x 490 x 11 mm	52 x 490 x 18/11 mm	300 x 300 x 15 mm	Work size
	smooth, glossy	smooth, glossy	smooth, glossy	Surface
	32.258/m ²	32.258/m ²	3.226/m	m ² /m - pieces
	18.710/m ²	27.097 m ²	8.904/m	m ² /m - kg
	22	13	8	Bundle - pieces
	0.682 m ²	0.403 m ²	2.480 m	Bundle - m ² /m
	12.760	10.920	22.080	Bundle - kg
	40.920	24.180		Pallet - m ²
	765.600	655.200		Pallet - kg
	Alla	Alla	Alla	Product standard
	19027-2320	19027-2290	19027-9215	
	Price gr. A211 (m ²)	Price gr. A361 (m ²)	Price gr. A471 (pce.)	lime-white
	19026-2320	19026-2290	19026-9215	
	Price gr. A211 (m ²)	Price gr. A361 (m ²)	Price gr. A471 (pce.)	natural-white
	19022-2320	19022-2290	19022-9215	
	Price gr. A211 (m ²)	Price gr. A361 (m ²)	Price gr. A471 (pce.)	pearl-grey
	19021-2320	19021-2290 ^{1/3}	19021-9215	
	Price gr. A211 (m ²)	Price gr. A361 (m ²)	Price gr. A471 (pce.)	natural-grey
	19020-2320	19020-2290	19020-9215	
	Price gr. A211 (m ²)	Price gr. A361 (m ²)	Price gr. A471 (pce.)	reed-green flamed
	19025-2320	19025-2290	19025-9215	
	Price gr. A211 (m ²)	Price gr. A361 (m ²)	Price gr. A471 (pce.)	redbrown flamed
	19024-2320	19024-2290	19024-9215	
	Price gr. A211 (m ²)	Price gr. A361 (m ²)	Price gr. A471 (pce.)	petrol-blue flamed
	19030-2320	19030-2290	19030-9215	
	Price gr. A211 (m ²)	Price gr. A361 (m ²)	Price gr. A471 (pce.)	reseda-green
	19031-2320	19031-2290 ^{1/3}	19031-9215	
	Price gr. A211 (m ²)	Price gr. A361 (m ²)	Price gr. A471 (pce.)	crimson
	19032-2320	19032-2290 ^{1/3}	19032-9215	
	Price gr. A211 (m ²)	Price gr. A361 (m ²)	Price gr. A471 (pce.)	cobalt-blue
	19033-2320	19033-2290 ^{1/3}	19033-9215	
	Price gr. A211 (m ²)	Price gr. A361 (m ²)	Price gr. A471 (pce.)	deep-black

¹  Make-to-order production: return and/or cancellation of ordered products not possible.



² Color Shade Variation

V1: lime-white, natural-white, pearl-grey, natural-grey, reseda-green, crimson, cobalt-blue, deep-black

V2: reed-green flamed

V3: redbrown flamed, cobalt-blue flamed

³ Minimum order quantity: 250 m²

For the series Craft Extended:

Minimum order quantity in the case of the colors specified above: 250 m²

Minimum order quantity in the case of special colors: 500 m²

Price for lower quantities on request.

The customer agrees to purchase a possible overproduction of 10 %.

Overglazed edge(s) possible up to max. 10% of the order quantity. A separate order is necessary



Studio photo / Architect: VSBL, Belgrade, Serbia / Series: District / Photo: Jochen Stüber



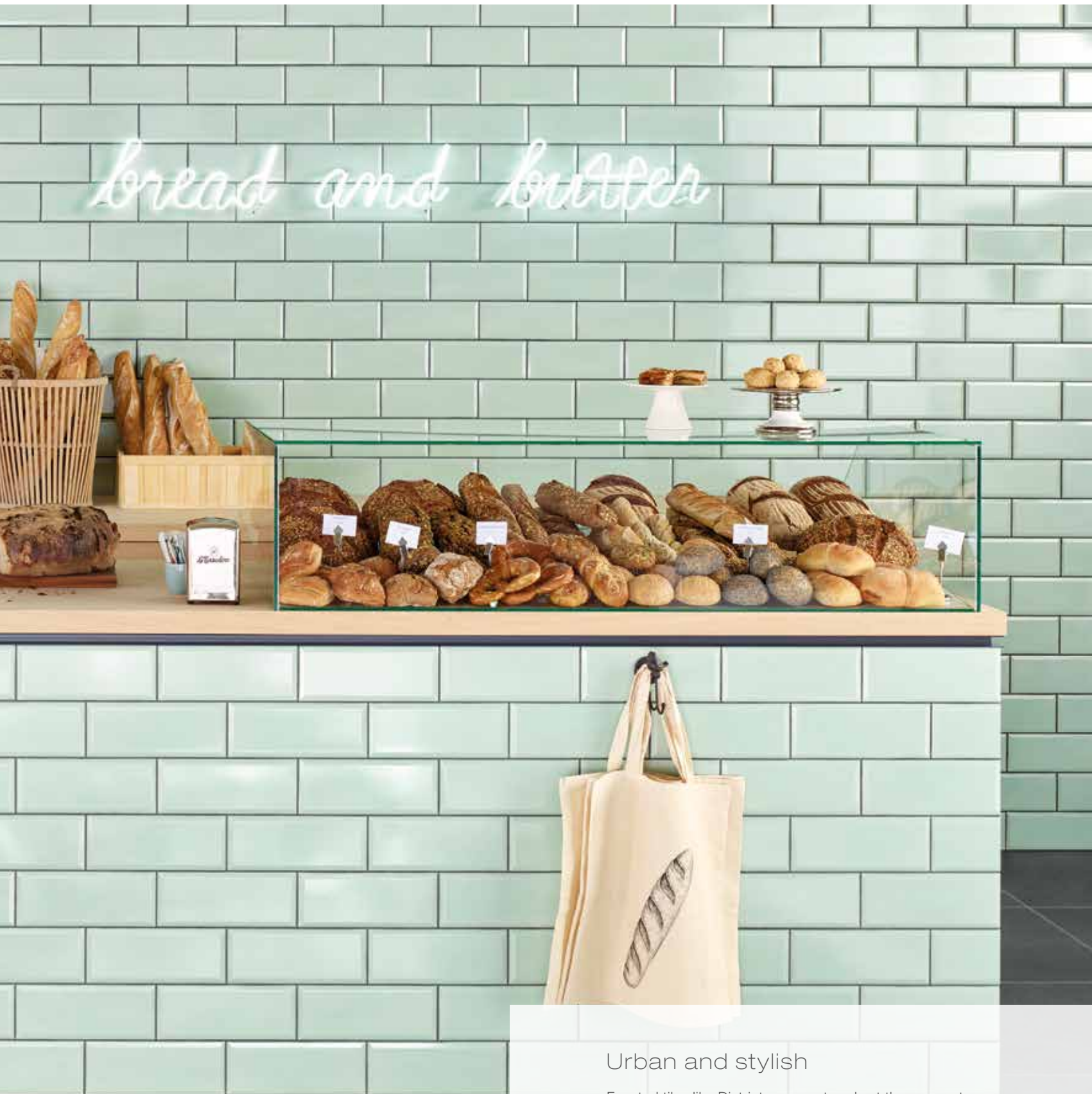

Urban and stylish

Faceted tiles like District are very trendy at the moment. Whether in kitchens, bathrooms, shops or living areas – they create a noble, minimalist or stylish look, depending on the color and area of application. With District, there are eight trendy colors to choose from. All are available in the formats of 5 x 10 cm and 10 x 25 cm. Thanks to the thermoplastic glueing on the back in the case of the 5 x 10 cm format, they are particularly easy to lay as sheets in addition.



Wall tile 5 x 10 cm, 2 x 4 in, Facette almond beige, smooth



Wall tile 5 x 10 cm, 2 x 4 in, Facette white, smooth



Wall tile 10 x 25 cm, 4 x 10 in, Facette almond beige, smooth

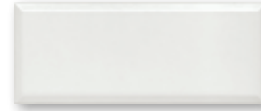

Wall tile 10 x 25 cm, 4 x 10 in, Facette white, smooth

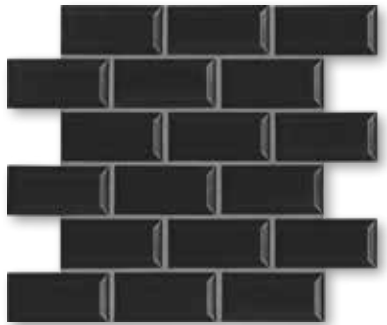

Wall tile 5 x 10 cm, 2 x 4 in, Facette pitch black, smooth



Wall tile 5 x 10 cm, 2 x 4 in, Facette ash grey, smooth



Wall tile 10 x 25 cm, 4 x 10 in, Facette pitch black, smooth



Wall tile 10 x 25 cm, 4 x 10 in, Facette ash grey, smooth



Wall tile 5 x 10 cm, 2 x 4 in, Facette miami mint, smooth

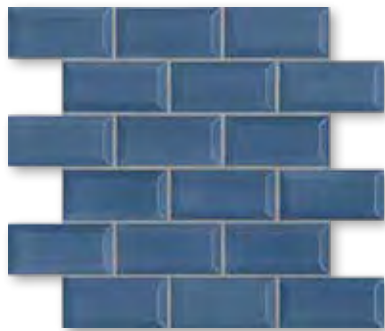

Wall tile 5 x 10 cm, 2 x 4 in, Facette denim blue, smooth



Wall tile 10 x 25 cm, 4 x 10 in, Facette miami mint, smooth



Wall tile 10 x 25 cm, 4 x 10 in, Facette denim blue, smooth



Wall tile 5 x 10 cm, 2 x 4 in, Facette racing green, smooth



Wall tile 5 x 10 cm, 2 x 4 in, Facette burgundy red, smooth



Wall tile 10 x 25 cm, 4 x 10 in, Facette racing green, smooth



Wall tile 10 x 25 cm, 4 x 10 in, Facette burgundy red, smooth

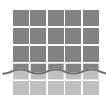

Mosaics glued thermoplastically on back of AGROB BUCHTAL can be used not only in dry zones but also without any problems in underwater areas (e.g. swimming pools/whirlpools) as well as in permanently wet areas (e.g. pool surrounds/showers).

Wall Tiles

5 x 10 cm¹

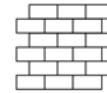

10 x 25 cm



Facette
Mosaic, glued
thermoplastically
on back
Sheet: 316 x 316 mm

Facette



				5 x 10 / 2 x 4	10 x 25 / 4 x 10	Nom. dim. - cm/in
				50 x 100 x 6.5 mm	97 x 247 x 6.5 mm	Work size
				smooth, glossy	smooth, glossy	Surface
				10 sheets	40.000	m ² - pieces
				16.570	19.000	m ² - kg
				8 sheets	20	Bundle - pieces
				0.800	0.500	Bundle - m ²
				13.256	9.500	Bundle - kg
				48.000	64.000	Pallet - m ²
				795.360	1,216.000	Pallet - kg
				Bib	Bib	Product standard
				45550H	45600H	
				Price gr. A187 (m ²)	Price gr. A169 (m ²)	almond beige
				45551H	45601H	
				Price gr. A187 (m ²)	Price gr. A169 (m ²)	white
				45552H	45602H	
				Price gr. A187 (m ²)	Price gr. A169 (m ²)	pitch black
				45553H	45603H	
				Price gr. A187 (m ²)	Price gr. A169 (m ²)	ash grey
				45554H	45604H	
				Price gr. A187 (m ²)	Price gr. A169 (m ²)	miami mint
				45555H	45605H	
				Price gr. A187 (m ²)	Price gr. A169 (m ²)	denim blue
				45556H	45606H	
				Price gr. A187 (m ²)	Price gr. A169 (m ²)	racing green
				45557H	45607H	
				Price gr. A187 (m ²)	Price gr. A169 (m ²)	burgundy red

Only suitable for laying on the wall.



All products: Color Shade Variation V0





Conductive floor coverings

These two specific solutions – as a stoneware tile (Eladuct) on the one hand and as a ceramic large-size panel in model size 60 x 60 cm on the other (ELA 10.6) – are suitable for use in those areas where electrostatic charge requires a conductive floor covering or where the latter is recommended. The special laying instructions must be followed carefully. We shall be delighted to advise you and to give you assistance for individual applications.

ELADUCT

Static electricity conducting stoneware tiles, unglazed



3555
Eladuct unglazed

Sectional Drawing

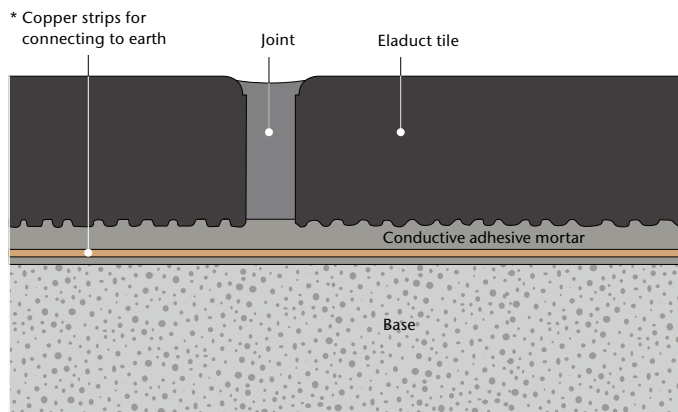

* Number and arrangement depending on the technical requirements.
Connection only by an electrical specialist in line with the relevant guidelines.

In the case of Eladuct, static electricity is discharged through the tile body.
Volume resistance according to Procedure A pursuant to DIN EN 1081: 10^8 Ohm.



Conductive Floor Coverings

These two specific solutions – as a stoneware tile (Eladuct) on the one hand and as a ceramic large-size panel in model size 60 x 60 cm on the other (ELA 10.6) – are suitable for use in those areas where electrostatic charge requires a conductive floor covering or where the latter is recommended. The special laying instructions must be followed carefully. We shall be delighted to advise you and to give you assistance for individual applications.

Eladuct

is especially predestined for those areas where the discharge of static electricity is desired together with the advantages of an unglazed surface (high mechanical-chemical stress resistance).

Examples: gravure and flexographic printing areas, laboratories, rooms for lacquer production, processing and decanting, munitions dumps, chemical production plants etc.

KERAION ELA 10.6



2401 RH - IV
grey glazed
(RH = non-slip version)

Sectional Drawing

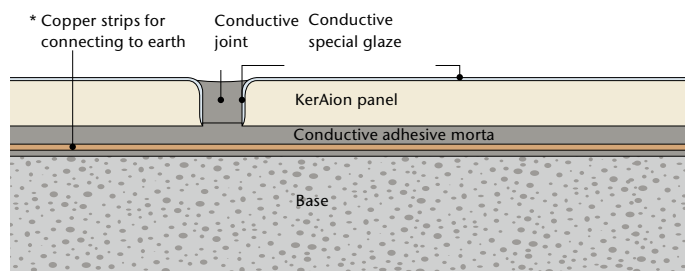

* Number and arrangement depending on the technical requirements.
Connection only by an electrical specialist in line with the relevant guidelines.

In the case of ELA 10.6, static electricity is discharged via the four overglazed panel edges.
Surface resistance according to Procedure C pursuant to DIN EN 1081: 10^6 Ohm.
Electrical leakage resistance R_A according to DIN EN 1081: 10^6 Ohm.



KerAion ELA 10.6

is recommended for those areas where the discharge of static electricity is desired and importance is attached to the advantages of a glazed surface (e.g. very easy to clean) and a generous, representative look.

Examples: office rooms, production rooms for electronic equipment, physical measuring and work rooms, laboratories, rooms for microchip and computer manufacture, medical areas (e.g. operating theatres), telecommunication workshops, sales areas for electronic equipment etc.

Floor Tiles

Skirtings

25 x 12.5 cm

25 x 8.9 cm



			1110	4000	4003	4004	
			25 x 12.5 / 10 x 5	25 x 8.9 / 10 x 3 1/2			Model number
			240 x 115 x 20	240 x 79/9 x 11	(2x) 131 x 79/9 x 11	(2x) 115 x 79/9 x 11	Nom. dim. - cm/in
			smooth, matt	smooth, matt	smooth, matt	smooth, matt	Work size mm
			33.000/m ²	4.000/m			Surface
			53.955/m ²	2.200/m	0.590/pair	0.550/pair	m ² /m - pieces
			14 pieces	16 pieces	8 pair	8 pair	m ² /m/pair - kg
			0.424 m ²	4.000 m			Bundle - pce./pair
			22.890	8.800	4.720	4.400	Bundle - m ² /m
			30.545				Bundle - kg
			1,648.080				Pallet - m ²
			Alb	Alb	Alb	Alb	Pallet - kg
			R10				Product standard
			4				Slip resistance
			3555-1110	3555-4000	3555-4003	3555-4004	Stress group
			Price gr. A346 (m ²)	Price gr. A467 (pce.)	Price gr. A528 (pair)	Price gr. A528 (pair)	3555 Eladuct unglazed

In the case of Eladuct, static electricity is discharged through the tile body.

Volume resistance according to Procedure A pursuant to DIN EN 1081: 10⁸ Ohm.

The 355s is defined by the contact resistance and not by the color setting. Color deviations must be accepted and are no reason for complaint!



All products: Color Shade Variation V0

KERAION ELA 10.6

Floor Tiles

(static electricity conducting)

Skirtings

(static electricity non-conducting)

60 x 60 cm

30 x 8.7 cm

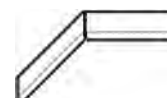

			K100	37040	37043	37044	37042	
			60 x 60 / 24 x 24	30 x 8.7 / 12 x 3 1/2				Model number
			592 x 592 x 8	292 x 79/12 x 8	280/292 x 79/12 x 8	280/292 x 79/12 x 8	(2x) 292 x 79/12 x 8	Nom. dim. - cm/in
			smooth, matt	smooth, matt	smooth, matt	smooth, matt	smooth, matt	Work size mm
			2.860/m ²	3.333/m				Surface
			18.533/m ²	1.700/m	0.550/pieces	0.550/pieces	1.100/pair	m ² /m - pieces
			4 pieces	32 pieces	32 pieces	32 pieces	16 pair	m ² /m/pce./pair - kg
			1.399 m ²	9.601 m	17.600	17.600	17.600	Bundle - pce./pair
			25.920	16.320				Bundle - m ² /m
			41.958					Bundle - kg
			777.600					Pallet - m ²
			Alb	Alb	Alb	Alb	Alb	Pallet - kg
			R9					Product standard
			2					Slip resistance
			2401RH-K100-21					Stress group
			Price gr. A346 (m ²)	590-37040-21	590-37043-21	590-37044-21	590-37042-21	4
				Price gr. A445 (pce.)	Price gr. A458 (pce.)	Price gr. A458 (pce.)	Price gr. A489 (pair)	grey glazed
								grey glazed

In the case of Keraion ELA 10.6, static electricity is discharged via the four overlaid panel edges. Surface resistance according to Procedure C pursuant to DIN EN 1081: 10⁹ Ohm.



All products: Color Shade Variation V0

Studio photo / Architect: Sylvia Leydecker / Series: Emotion / Photo: Jochen Stüber





Modular and timeless

With colors and surfaces matched to one another, slip-resistant tiles from R9 to R12V4 and formats from 20 x 20 to 60 x 60 cm, the tiles of the Emotion series offer architects a great deal of freedom. Emotion ensures good design above all where there are transitions between areas with different slip-resistance requirements. Front cooking in visual contact with the restaurant guests is thus just as possible as the smooth and aesthetically successful coexistence of workshop and showroom in a car dealership.



R9 R10/A R10/A+B R10/B R11/B



Surfaces: Floor tiles

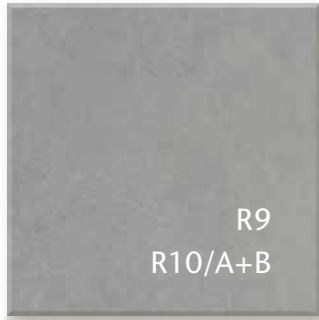

basalt

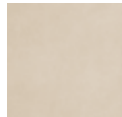

light-beige



deep anthracite

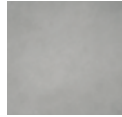

mid-grey

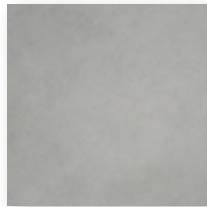

Floor tile 20 x 20 cm, 8 x 8 in smooth, R10/A+B



Floor tile 30 x 30 cm, 12 x 12 in structured, R10/A



Floor tile 30 x 30 cm, 12 x 12 in relief, R11/B



Floor tile 30 x 60 cm, 12 x 24 in, smooth, R9
 Floor tile 30 x 60 cm, 12 x 24 in, structured, R10/A
 Floor tile 30 x 60 cm, 12 x 24 in, relief, R11/B



Floor tile 60 x 60 cm, 24 x 24 in, smooth, R9
 Floor tile 60 x 60 cm, 24 x 24 in, structured, R10/A



Cove skirting 10 x 20 cm, 4 x 8 in**
 smooth, R10/A



Cove skirting 10 x 30 cm, 4 x 12 in**
 smooth, R10/A



Internal corner for cove skirting**
 smooth



External corner for cove skirting**
 smooth

** Color deviation due to fine-grained look.



Stair tile 30 x 60 cm, 12 x 24 in, (with grooves), smooth, R9
 Stair tile 30 x 60 cm, 12 x 24 in, (with grooves), structured, R10/A



Skirting, rounded 7 x 60 cm, 2 13/16 x 24 in, smooth
 Skirting, rounded 7 x 60 cm, 2 13/16 x 24 in, structured

Ceramic channel cover*
 Corner solution 30 x 30 cm, 12 x 12 in

Ceramic channel cover*
 25 x 50 cm, 10 x 20 in

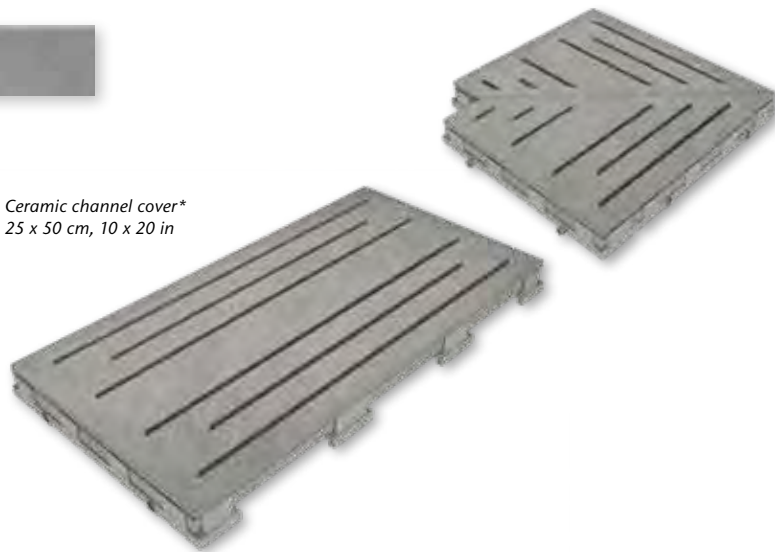

* For details, refer to the chapter Pool + Spa; Ceramic channel cover 2.0, page 451 (make-to-order production).

Wall tiles

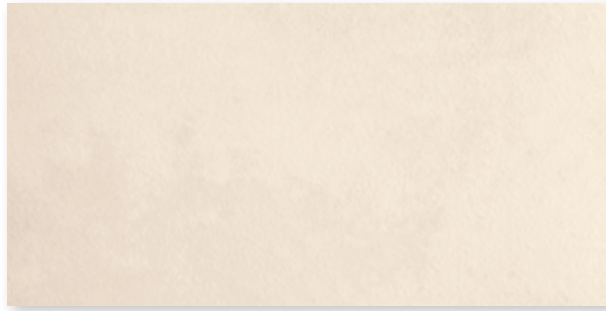

Wall tile 30 x 60 cm, 12 x 24 in, smooth, light-beige



Wall tile 30 x 60 cm, 12 x 24 in, smooth, mid-grey

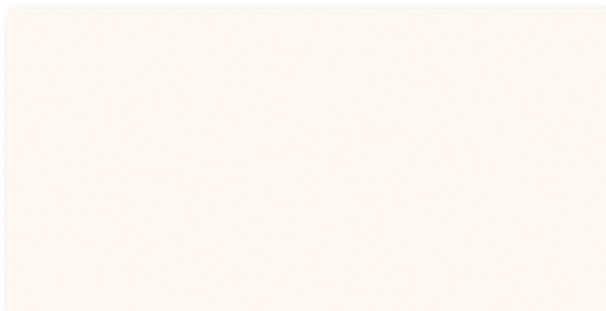

Wall tile 30 x 60 cm, 12 x 24 in, smooth, sand-white

Borders and Decoration Elements



Border Shades 15 x 60 cm, 6 x 24 in, smooth, bronze-golden



Decorative tile Shades 30 x 60 cm, 12 x 24 in, smooth, bronze-golden



Border Rocks 10 x 60 cm, 4 x 24 in, relief, bronze

Wall Tile⁴ Borders and Decoration Elements^{1/2/3}

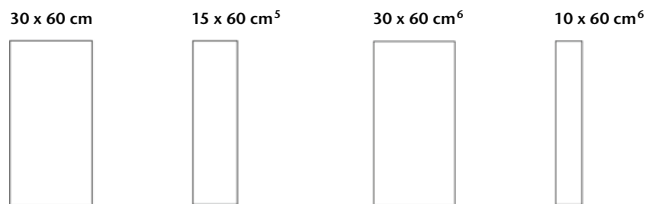

Border Shades
Porcelain stoneware
Set of 2

Decorative Tile Shades
Porcelain stoneware

Border Rocks
Porcelain stoneware
Set of 2

Nom. dim. - cm/in	30 x 60 / 12 x 24	15 x 60 / 6 x 24	30 x 60 / 12 x 24	10 x 60 / 4 x 24			
Work size	297 x 597 x 9 mm	147 x 597 x 10.5 mm	297 x 597 x 10.5 mm	97 x 597 x 9 mm			
Surface	smooth, silky-matt	smooth, matt	smooth, matt	relief, polished			
m ² /m - pieces	5.556/m ²	1.667/m	1.667/m	1.667/m			
m ² /m - kg	14.946/m ²	3.484/m	6.968/m	2.367/m			
Bundle - pieces	9	2	2	2			
Bundle - m ² /m	1.620 m ²	1.200 m	1.200 m	1.200 m			
Bundle - kg	24.210	4.180	8.360	2.840			
Pallet - m ²	77.754						
Pallet - kg	1,162.083						
Product standard	BIII	Bla	Bla	Bla			
sand-white	281757H Price gr. A88 (m ²)						
light-beige	281759H Price gr. A88 (m ²)						
medium grey	281758H Price gr. A88 (m ²)						
bronze-gold		433715 Price gr. 2 x A506 (Set)	433716 Price gr. A556 (pce.)				
bronze				433725 Price gr. 2 x A593 (Set)			

¹ without Hytect coating

² Only suitable for laying on the wall.

³ rectified

⁴ Color Shade Variation: V1

⁵ Color Shade Variation: V3

⁶ Color Shade Variation: V2

Note: decoration elements only available in full boxes.

Floor Tiles¹

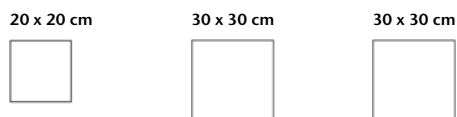

Nom. dim. - cm/in	20 x 20 / 8 x 8	30 x 30 / 12 x 12	30 x 30 / 12 x 12				
Work size	197 x 197 x 10.5 mm	297 x 297 x 10.5 mm	297 x 297 x 10.5 mm				
Surface	smooth, matt	structured, matt	relief, matt				
m ² - pieces	25.000	11.110	11.110				
m ² - kg	22.900	23.142	23.142				
Bundle - pieces	21	11	11				
Bundle - m ²	0.840	0.990	0.990				
Bundle - kg	19.236	22.913	22.913				
Pallet - m ²	50.400	47.525	47.525				
Pallet - kg	1,154.160	1,099.824	1,099.824				
Product standard	Bla	Bla	Bla				
Slip resistance	R10/A+B	R10/A	R11/B				
Stress group	2 - 3	2 - 3	2 - 3				
deep anthracite	432016 Price gr. A121 (m ²)	433730 Price gr. A88 (m ²)	433733 Price gr. A100 (m ²)				
light-beige	432017 Price gr. A121 (m ²)	433732 Price gr. A88 (m ²)	433735 Price gr. A100 (m ²)				
medium grey	432018 Price gr. A121 (m ²)	433731 Price gr. A88 (m ²)	433734 Price gr. A100 (m ²)				
basalt	432019 Price gr. A121 (m ²)	433440 Price gr. A88 (m ²)	433442 Price gr. A100 (m ²)				

¹ Color Shade Variation: V2



Floor Tiles²

30 x 60 cm¹



30 x 60 cm¹



30 x 60 cm¹



60 x 60 cm¹



60 x 60 cm¹



protected

	30 x 60 / 12 x 24	30 x 60 / 12 x 24	30 x 60 / 12 x 24	60 x 60 / 24 x 24	60 x 60 / 24 x 24	Nom. dim. - cm/in
	297 x 597 x 10.5 mm	297 x 597 x 10.5 mm	297 x 597 x 10.5 mm	597 x 597 x 10.5 mm	597 x 597 x 10.5 mm	Work size
	smooth, matt	structured, matt	relief, matt	smooth, matt	structured, matt	Surface
	5.556	5.556	5.556	2.778	2.778	m ² - pieces
	23.224	23.224	23.224	23.769	23.769	m ² - kg
	6	6	6	3	3	Bundle - pieces
	1.080	1.080	1.080	1.080	1.080	Bundle - m ²
	25.080	25.080	25.080	25.668	25.668	Bundle - kg
	43.197	43.197	43.197	38.877	38.877	Pallet - m ²
	1,003.200	1,003.200	1,003.200	924.048	924.048	Pallet - kg
	Bla	Bla	Bla	Bla	Bla	Product standard
	R9	R10/A	R11/B	R9	R10/A	Slip resistance
	2 - 3	2 - 3	2 - 3	2 - 3	2 - 3	Stress group
	433402	433406	433410	433660	433664	deep anthracite
	Price gr. A121 (m ²)	Price gr. A121 (m ²)	Price gr. A154 (m ²)	Price gr. A142 (m ²)	Price gr. A142 (m ²)	
	433404	433408	433412	433662	433666	light-beige
	Price gr. A121 (m ²)	Price gr. A121 (m ²)	Price gr. A154 (m ²)	Price gr. A142 (m ²)	Price gr. A142 (m ²)	
	433403	433407	433411	433661	433665	medium grey
	Price gr. A121 (m ²)	Price gr. A121 (m ²)	Price gr. A154 (m ²)	Price gr. A142 (m ²)	Price gr. A142 (m ²)	
	433430	433432	433434	433436	433438	basalt
	Price gr. A121 (m ²)	Price gr. A121 (m ²)	Price gr. A154 (m ²)	Price gr. A142 (m ²)	Price gr. A142 (m ²)	



² Color Shade Variation: V2



Stair Tiles^{1/2/3}

30 x 60 cm



30 x 60 cm



7 x 60 cm



7 x 60 cm



protected

	30 x 60 / 12 x 24	30 x 60 / 12 x 24	7 x 60 / 2 13/16 x 24	7 x 60 / 2 13/16 x 24	Nom. dim. - cm/in
	297 x 597 x 10.5 mm	297 x 597 x 10.5 mm	70 x 597 x 10.5 mm	70 x 597 x 10.5 mm	Work size
	smooth, matt	structured, matt	smooth, matt	structured, matt	Surface
	1.667	1.667	1.667	1.667	m ² - pieces
	6.968	6.968	1.717	1.717	m ² - kg
	6	6	22	22	Bundle - pieces
	3.599	3.599	13.197	13.197	Bundle - m ²
	25.080	25.080	22.660	22.660	Bundle - kg
	Bla	Bla	Bla	Bla	Pallet - m ²
	R9	R10/A			Pallet - kg
	2 - 3	2 - 3			Product standard
	433850	433854	433802	433806	Slip resistance
	Price gr. A475 (pce.)	Price gr. A475 (pce.)	Price gr. A434 (pce.)	Price gr. A434 (pce.)	Stress group
	433852	433856	433804	433808	deep anthracite
	Price gr. A475 (pce.)	Price gr. A475 (pce.)	Price gr. A434 (pce.)	Price gr. A434 (pce.)	
	433851	433855	433803	433807	light-beige
	Price gr. A475 (pce.)	Price gr. A475 (pce.)	Price gr. A434 (pce.)	Price gr. A434 (pce.)	
	433817	433819	433821	433823	medium grey
	Price gr. A475 (pce.)	Price gr. A475 (pce.)	Price gr. A434 (pce.)	Price gr. A434 (pce.)	
					basalt



² Make-to-order production: return and/or cancellation of ordered products not possible.

³ Color Shade Variation: V2



Cove skirting^{1/3/4}

Internal Corner for Cove Skirting^{1/2/3/4}

External Corner for Cove Skirting^{1/2/3/4}

Cove skirting^{5/6/7/8/9/10}

Internal Corner 15 x 60 cm^{5/6/7/8/9/10}



protected

10 x 20 cm



10 x 30 cm



	<i>Fin grain</i>	<i>Fin grain</i>	<i>Fin grain</i>	<i>Fin grain</i>		
Nom. dim. - cm/in	10 x 20 / 4 x 8	10 x 30 / 4 x 12			15 x 60 / 6 x 24	15 x 15 / 6 x 6
Work size	102 x 197 x 9 mm	102 x 297 x 9 mm	102 x 35 x 9 mm	102 x 35 x 9 mm	158 x 597 x 10.5 mm	158 x 158 x 10.5 mm
Surface	smooth, matt	smooth, matt	smooth, matt	smooth, matt	structured, matt	structured, matt
m - pieces	5.000	3.333			1.667	
m - kg	2.000	1.999	0.080/pieces	0.080/pieces	4.334	
Bundle - pieces	20	16	18	12	4	4
Bundle - m	4.000	4.800			2.399	
Bundle - kg	8.000	9.600			10.400	6.000
Pallet - m ²						
Pallet - kg						
Product standard	Bla	Bla	Bla	Bla	Bla	Bla
Slip resistance	R10/A	R10/A			R10/A	R10/A
	432027	432033	432039	432045		
deep anthracite	Price gr. A419 (pce.)	Price gr. A425 (pce.)	Price gr. A418 (pce.)	Price gr. A418 (pce.)		
	432029	432035	432041	432047	432805-HKS	432805-IE
light-beige	Price gr. A419 (pce.)	Price gr. A425 (pce.)	Price gr. A418 (pce.)	Price gr. A418 (pce.)	Price gr. A573 (pce.)	Price gr. A601 (pce.)
	432028	432034	432040	432046		
medium grey	Price gr. A419 (pce.)	Price gr. A425 (pce.)	Price gr. A418 (pce.)	Price gr. A418 (pce.)		
	432030	432036	432042	432048		
basalt	Price gr. A419 (pce.)	Price gr. A425 (pce.)	Price gr. A418 (pce.)	Price gr. A418 (pce.)		



¹ For details, refer to page 716

² Fitting to cove skirting 10 x 20 cm / 10 x 30 cm

³ Attention: Color deviation from the rest of the Emotion range, as fine-grain look.

⁴ Color Shade Variation: V1

⁵ Minimum order quantity 50 pieces

⁶ Other colors available on request.

⁷  rectified

⁸  Make-to-order production: return and/or cancellation of ordered products not possible.

⁹ For detail drawings of cove skirting and internal corner, refer to page 716

¹⁰ Color Shade Variation V2

Studio photo / Architect: Iris Andernach / Series: Emotion / Photo: Jochen Stüber



Project: KUBEZ (cultural and meeting centre) / Location: Dietach, Germany / Architect: Team M Architekten ZT GesmbH / Series: Emotion Grip / Photo: Roland Reuter, Absam







R10/A R11/B R11V4 R12 R12V4 R12V8 R13 R13V10



Surfaces: Floor tiles

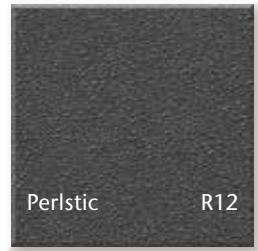
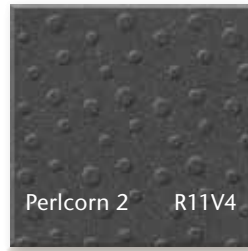

basalt



light-beige



deep anthracite



mid-grey



Floor tile 20 x 20 cm, 8 x 8 in, smooth, R10/A
 Floor tile 20 x 20 cm, 8 x 8 in, Softcorn 2, R11/B
 Floor tile 20 x 20 cm, 8 x 8 in, Perlcorn 2, R11V4
 Floor tile 20 x 20 cm, 8 x 8 in, Perlstic, R12
 Floor tile 20 x 20 cm, 8 x 8 in, Carostic, R12V4
 Floor tile 20 x 20 cm, 8 x 8 in, Picstic, R12V8, extra thick
 Floor tile 20 x 20 cm, 8 x 8 in, roughened, R13, extra thick
 Floor tile 20 x 20 cm, 8 x 8 in, Kombicorn, R13V10, extra thick

Mosaic 10 x 10 cm, 4 x 4 in

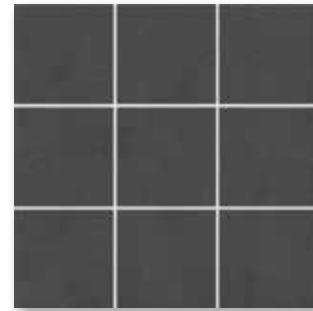

Mosaic sheet 30 x 30 cm, 12 x 12 in, smooth, R10/B



Floor tile 30 x 30 cm, 12 x 12 in, smooth, R10/A



Stair tile 30 x 30 cm, 12 x 12 in (with grooves), smooth, R10/A



Skirting with bevel 10 x 20 cm, 4 x 8 in, smooth



Cove skirting 10 x 20 cm, 4 x 8 in, smooth, R10/A



Cove skirting 10 x 30 cm, 4 x 12 in, smooth, R10/A



Internal corner for cove skirting, smooth



External corner for cove skirting, smooth



yellow



black



Safety triangles, extra thick 27.8 x 20 cm, grained, R11



Laying pattern

Mosaic¹ **NEW** Wall/Floor Tiles



10 x 10 cm

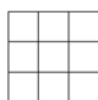

20 x 20 cm



20 x 20 cm



20 x 20 cm



20 x 20 cm



20 x 20 cm



Mosaic, glued thermoplastically on back

Sheet: 297 x 297 mm

Smooth

Softcorn 2

Perlcor 2

Perlstic

Carostic

Nom. dim. - cm/in	10 x 10 / 4 x 4	20 x 20 / 8 x 8	20 x 20 / 8 x 8	20 x 20 / 8 x 8	20 x 20 / 8 x 8	20 x 20 / 8 x 8
Work size	97 x 97 x 6.5 mm	197 x 197 x 10.5 mm	197 x 197 x 10.5 mm	197 x 197 x 10.5 mm	197 x 197 x 10.5 mm	197 x 197 x 10.5 mm
Surface	smooth, matt	smooth, matt	structured, matt	fine-grained, matt	fine-grained, matt	profiled, matt
m ² - pieces	11 sheets	25.000	25.000	25.000	25.000	25.000
m ² - kg	13.101	22.900	22.900	22.900	22.900	22.900
Bundle - pieces	11 sheets	21	21	21	21	21
Bundle - m ²	1.000	0.840	0.840	0.840	0.840	0.840
Bundle - kg	13.101	19.236	19.236	19.236	19.236	19.236
Pallet - m ²	64.000	50.400	50.400	50.400	50.400	50.400
Pallet - kg	838.464	1,154.160	1,154.160	1,154.160	1,154.160	1,154.160
Product standard	Bla	Bla	Bla	Bla	Bla	Bla
Slip resistance	R10/B	R10/A	R11/B	R11V4	R12	R12V4
Stress group	1 - 2	3	3	3	3	3
deep anthracite	435026 Price gr. A148 (m ²) 435027	434216 Price gr. A121 (m ²) 434217	434219 Price gr. A121 (m ²) 434220	434222 Price gr. A154 (m ²) 434223	434225 Price gr. A154 (m ²) 434226	434228 Price gr. A154 (m ²) 434229
medium grey	Price gr. A148 (m ²) 435028	Price gr. A121 (m ²) 434218	Price gr. A121 (m ²) 434221	Price gr. A154 (m ²) 434224	Price gr. A154 (m ²) 434227	Price gr. A154 (m ²) 434230
light-beige	Price gr. A148 (m ²) 435029	Price gr. A121 (m ²) 434326	Price gr. A121 (m ²) 434328	Price gr. A154 (m ²) 434330	Price gr. A154 (m ²) 434332	Price gr. A154 (m ²) 434334
basalt	Price gr. A148 (m ²)	Price gr. A121 (m ²)	Price gr. A121 (m ²)	Price gr. A154 (m ²)	Price gr. A154 (m ²)	Price gr. A154 (m ²)



Wall/
Floor Tiles



30 x 30 cm



20 x 20 cm¹



20 x 20 cm¹



20 x 20 cm¹



20 x 20 cm¹



20 x 20 cm¹



20 x 20 cm¹



Smooth

Smooth, extra thick

Softcorn 2, extra thick

Perlstic, extra thick

Carostic, extra thick

Picstic, extra thick

Roughened, extra thick

Nom. dim. - cm/in	30 x 30 / 12 x 12	20 x 20 / 8 x 8	20 x 20 / 8 x 8	20 x 20 / 8 x 8	20 x 20 / 8 x 8	20 x 20 / 8 x 8	20 x 20 / 8 x 8
Work size	297 x 297 x 10.5 mm	197 x 197 x 15 mm	197 x 197 x 15 mm	197 x 197 x 15 mm	197 x 197 x 15 mm	197 x 197 x 15 mm	197 x 197 x 15 mm
Surface	smooth, matt	smooth, matt	structured, matt	fine-grained, matt	fine-grained, matt	smooth, matt	profiled, matt
m ² /m - pieces	11.111/m ²	25.767/m ²	25.767/m ²	25.767/m ²	25.767/m ²	25.767/m ²	25.767/m ²
m ² /m - kg	23.144/m ²	34.322/m ²	34.322/m ²	34.322/m ²	34.322/m ²	34.322/m ²	34.322/m ²
Bundle - pieces	11	15	15	15	15	15	15
Bundle - m ² /m	0.990 m ²	0.582 m ²	0.582 m ²	0.582 m ²	0.582 m ²	0.582 m ²	0.582 m ²
Bundle - kg	22.913	19.980	19.980	19.980	19.980	19.980	19.980
Pallet - m ²	47.520	34.928	34.928	34.928	34.928	34.928	34.928
Pallet - kg	1,099.824	1,198.800	1,198.800	1,198.800	1,198.800	1,198.800	1,198.800
Product standard	Bla	Bla	Bla	Bla	Bla	Bla	Bla
Slip resistance	R10/A	R10/A	R11/B	R12	R12V4	R12V8	R13
Stress group	3	4	4	4	4	4	4
deep anthracite	434239 Price gr. A100 (m ²) 434240	434231 Price gr. A154 (m ²) 434232	434233 Price gr. A154 (m ²) 434234	434235 Price gr. A166 (m ²) 434236	434237 Price gr. A166 (m ²) 434238	434976 Price gr. A181 (m ²) 434977	434978 Price gr. A181 (m ²) 434979
medium grey	Price gr. A100 (m ²) 434241	Price gr. A154 (m ²)	Price gr. A154 (m ²)	Price gr. A166 (m ²)	Price gr. A166 (m ²)	Price gr. A181 (m ²)	Price gr. A181 (m ²)
light-beige	Price gr. A100 (m ²) 434336						
basalt	Price gr. A100 (m ²)						



¹ Period of delivery on request

All products: Color Shade Variation V1

Skirting with Bevel Stair Tiles

20 x 20 cm¹



Kambicorn, extra thick

27.8 x 20 cm²



Safety triangles, extra thick

10 x 20 cm



Bla

30 x 30 cm³



Bla



protected

			20 x 20 / 8 x 8	27.8 x 20 / 11 x 8	10 x 20 / 4 x 8	30 x 30 / 12 x 12	Nom. dim. - cm/in
			197 x 197 x 15 mm	278 x 197/197 x 15 mm	97 x 197 x 10.5 mm	297 x 297 x 10.5 mm	Work size
			profiled, matt	fine-grained, matt	smooth, matt	smooth, matt	Surface
			25.767/m ²	3.597/1.798/m	5.000/m	3.333/m	m ² / m - pieces
			34.322/m ²	2.374/1.187/m	2.250/m	6.943/m	m ² / m/pce. - kg
			15	28	20	10	Bundle - pieces
			0.582 m ²	7.784/15.573 m	4.000 m	3.003 m	Bundle - m/m ²
			19.980	18.480	9.000	20.830	Bundle - kg
			34.928				Pallet - m ²
			1,198.800				Pallet - kg
			Bla	Bla	Bla	Bla	Product standard
			R13V10	R11	R10/A		Slip resistance
			4	4		3	Stress group
			434980		434248	434251	deep anthracite
			Price gr. A181 (m ²)		Price gr. A416 (pce.)	Price gr. A449 (pce.)	
			434981		434249	434252	medium grey
			Price gr. A181 (m ²)		Price gr. A416 (pce.)	Price gr. A449 (pce.)	
					434250	434253	light-beige
					Price gr. A416 (pce.)	Price gr. A449 (pce.)	
					434342	434344	basalt
					Price gr. A416 (pce.)	Price gr. A449 (pce.)	
				431321			yellow
				Price gr. A416 (pce.)			
				431320			black
				Price gr. A416 (pce.)			

¹ Period of delivery on request

² Specification of the logistical data for single-row or double-row installation.

³ Make-to-order production: return and/or cancellation of ordered products not possible.



Cove skirting¹

10 x 20 cm



10 x 30 cm



Internal Corner for Cove Skirting^{1/2}



External Corner for Cove Skirting^{1/2}



protected

			10 x 20 / 4 x 8	10 x 30 / 4 x 12	102 x 20 x 9 mm	102 x 35 x 9 mm	Nom. dim. - cm/in
			102 x 197 x 9 mm	102 x 297 x 9 mm	102 x 20 x 9 mm	102 x 35 x 9 mm	Work size
			smooth, matt	smooth, matt	smooth, matt	smooth, matt	Surface
			5.000	3.333			m - pieces
			2.000/m	2.000/m	0.080/pieces	0.080/pieces	m/pce. - kg
			20	16	18	12	Bundle - pieces
			4.000	4.801			Bundle - m
			8.000	9.600			Bundle - kg
							Pallet - m
							Pallet - kg
			Bla	Bla	Bla	Bla	Product standard
			R10/A	R10/A			Slip resistance
			432027	432033	432039	432045	deep anthracite
			Price gr. A419 (pce.)	Price gr. A425 (pce.)	Price gr. A418 (pce.)	Price gr. A418 (pce.)	
			432028	432034	432040	432046	medium grey
			Price gr. A419 (pce.)	Price gr. A425 (pce.)	Price gr. A418 (pce.)	Price gr. A418 (pce.)	
			432029	432035	432041	432047	light-beige
			Price gr. A419 (pce.)	Price gr. A425 (pce.)	Price gr. A418 (pce.)	Price gr. A418 (pce.)	
			432030	432036	432042	432048	basalt
			Price gr. A419 (pce.)	Price gr. A425 (pce.)	Price gr. A418 (pce.)	Price gr. A418 (pce.)	

¹ For details, refer to page 716

² Fitting to cove skirting 10 x 20 / 10 x 30 cm

All products: Color Shade Variation V1







Innovative and robust

Specialists achieve more. This also applies to the ceramic floor tiles of the Ferrum series, which were specially developed for the tough requirements of industrial plants. The integrally colored, unglazed split tiles are particularly slip-resistant and thus prevent accidents at work. They are extremely robust and exceed the compressive strength of concrete or coating materials many times over. A technically sophisticated range of accessories, which includes cove skirtings, nosing tiles and gutter tiles, facilitates the realization of company-specific complete solutions.



grey-white



grey-beige



stone-grey



colorado-brown



light-beige,
granulated

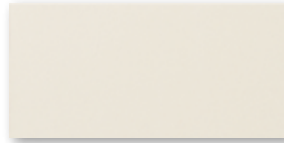

Floor tile 12.5 x 25 cm, 5 x 10 in, smooth, R10/A
Floor tile 12.5 x 25 cm, 5 x 10 in, structured, R11/A
Floor tile 12.5 x 25 cm, 5 x 10 in, smooth, R11/B



Nosing tile 12.5 x 25 cm, 5 x 10 in, smooth, R10/A
Nosing tile 12.5 x 25 cm, 5 x 10 in, smooth, R11/B

Cove skirting, r = 25 mm
12.5 x 25 cm, 5 x 10 in, smooth

External angle,
smooth



Internal angle,
smooth

Extra thick tiles up to 40 mm are available as special productions.

Floor Tiles

12.5 x 25 cm



12.5 x 25 cm²



12.5 x 25 cm



11 mm thick

14 mm thick

20 mm thick

				1100	1160	1110	Model number
				12.5 x 25 / 5 x 10	12.5 x 25 / 5 x 10	12.5 x 25 / 5 x 10	Nom. dim. - cm/in
				115 x 240 x 11 mm	115 x 240 x 14 mm	115 x 240 x 20 mm	Work size
				smooth, matt ⁴	smooth, matt ⁴	smooth, matt ⁴	Surface
				33.000	33.000	33.000	m ² - pieces
				22.869	28.380	41.679	m ² - kg
				24	20	14	Bundle - pieces
				0.727	0.606	0.424	Bundle - m ²
				16.632	17.200	17.682	Bundle - kg
				52.364	43.636	30.545	Pallet - m ²
				1,197.504	1,238.400	1,273.104	Pallet - kg
				Alb	Alb	Alb	Product standard
				see below	see below	see below	Slip resistance
				2	3	4	Stress group
				R10/A	R10/A	R10/A	
				900-1100	900-1160	900-1110	grey-beige
				Price gr. A115 (m ²)	Price gr. A154 (m ²)	Price gr. A211 (m ²)	
				R11/B	R11/B	R11/B	
				902R-1100	902R-1160	902R-1110	grey-white
				Price gr. A115 (m ²)	Price gr. A154 (m ²)	Price gr. A211 (m ²)	
				R11/B	R11/B	R11/B	
				929R-1100	929R-1160	929R-1110	stone-grey
				Price gr. A115 (m ²)	Price gr. A154 (m ²)	Price gr. A211 (m ²)	
						R11/B	
						950-1110¹	colorado-brown
						Price gr. A211 (m ²)	
				R11/A	R11/A	R11/A	
				964-1100	964-1160	964-1110	light-beige granulated
				Price gr. A115 (m ²)	Price gr. A154 (m ²)	Price gr. A211 (m ²)	

² Make-to-order production: return and/or cancellation of ordered products not possible.



⁴ Exception: light-beige granulated: structured, matt

Skirtings

Nosing Tile

25 x 12.5 cm



25 x 12.5 cm³



Cove skirting
r = 25 mm

External Corner

Internal Corner

				4030	4033	4034	4822	Model number
				25 x 12.5 / 10 x 5	25 x 12.5 / 10 x 5	25 x 12.5 / 10 x 5	25 x 12.5 / 10 x 5	Nom. dim. - cm/in
				240 x 125/20 x 11 mm	125 x 52 x 11 mm	125 x 31 x 11 mm	240 x 115/52 x 11 mm	Work size
				smooth, matt	smooth, matt	smooth, matt	smooth, matt	Surface
				4.000	0.200/pieces	0.170/pieces	4.000	m - pieces
				3.520/m	4	8	3.880/m	m/pce. - kg
				14			8	Bundle - pieces
				3.500			2.000	Bundle - m
				12.320	0.800	1.360	7.760	Bundle - kg
								Pallet - m
								Pallet - kg
				Alb	Alb	Alb	Alb	Product standard
							see below	Slip resistance
							R10/A	
				900-4030	900-4033	900-4034	900-4822	grey-beige
				Price gr. A434 (pce.)	Price gr. A445 (pce.)	Price gr. A445 (pce.)	Price gr. A434 (pce.)	
							R11/B	
				902R-4030	902R-4033	902R-4034	902R-4822	grey-white
				Price gr. A434 (pce.)	Price gr. A445 (pce.)	Price gr. A445 (pce.)	Price gr. A434 (pce.)	
							R11/B	
				929R-4030	929R-4033	929R-4034	929R-4822	stone-grey
				Price gr. A434 (pce.)	Price gr. A445 (pce.)	Price gr. A445 (pce.)	Price gr. A434 (pce.)	
				950-4030¹	950-4033¹	950-4034¹		colorado-brown
				Price gr. A434 (pce.)	Price gr. A445 (pce.)	Price gr. A445 (pce.)		

¹ Exception: the color colorado-brown corresponds to the DIN EN 14411, group All_a.

³ Also available in the color light-beige, granulated on request.

For gutter tiles (trough depth 15 mm), refer to chapter Pool + SPA – series special tiles page 444 et seq.

All products: Color Shade Variation V0



Note: Surface to be treated with a suitable impregnation agent, refer to page 707





Fresh and modern

Fresh offers a harmonious range of modern, fresh colors in the popular mosaic formats of 2.5 x 2.5 cm and 5 x 5 cm, with which individual, but at the same time uncomplicated to realize designs are possible. A particularly practical advantage is that R10/B and R10/C slip-resistant mosaics in colors matching the tiles are available.

Fresh: modern clarity for individual design



2.5 x 2.5 cm, 1 x 1 in

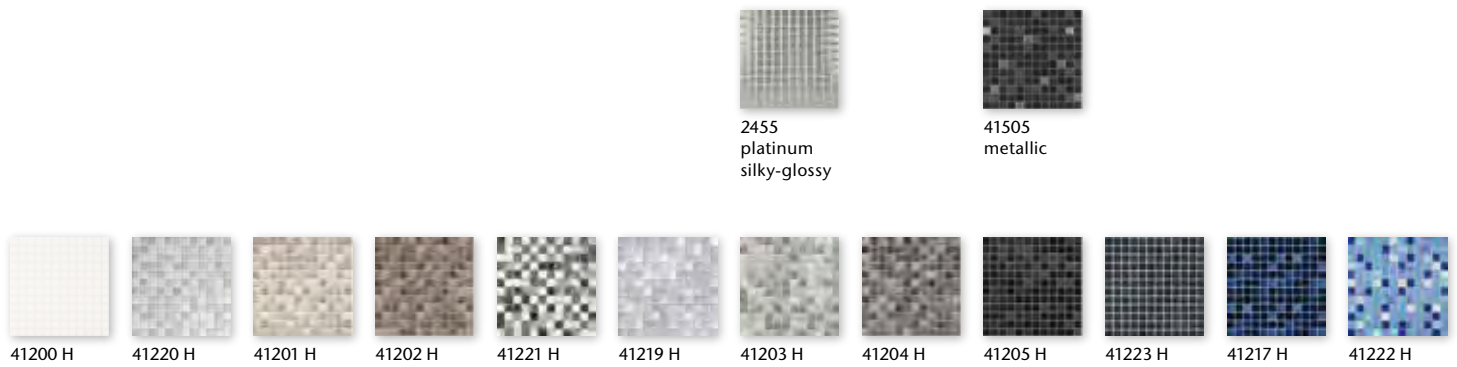

2.5 x 2.5 cm, 1 x 1 in, non-slip R10/B



5 x 5 cm, 2 x 2 in, non-slip R10/B & R11/C



denim blue-mix	light blue-mix	pacific blue-mix	midnight blue-mix	vivid violet-mix	sunset orange-mix	coral red-mix	brick red mix	mystic red-mix	forest green mix	lime green-mix	sunshine yellow-mix
----------------	----------------	------------------	-------------------	------------------	-------------------	---------------	---------------	----------------	------------------	----------------	---------------------

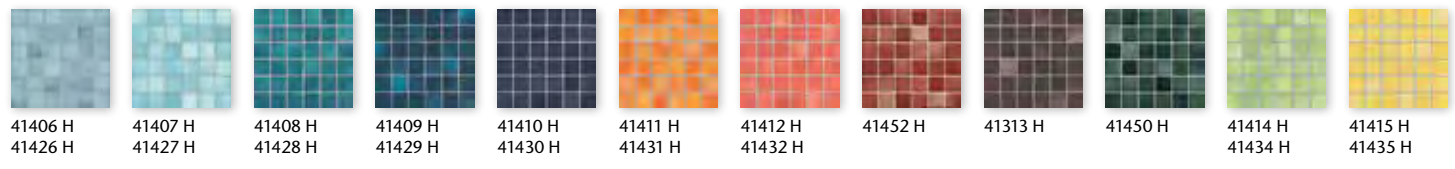
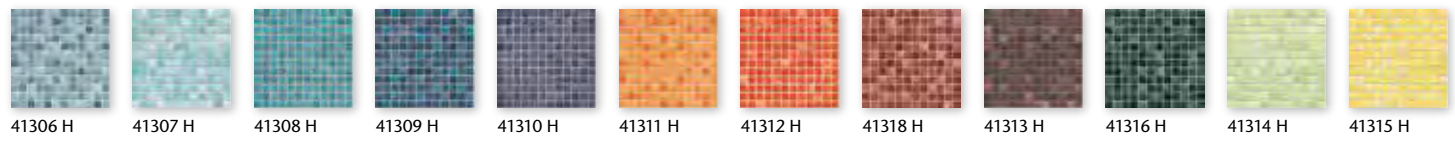
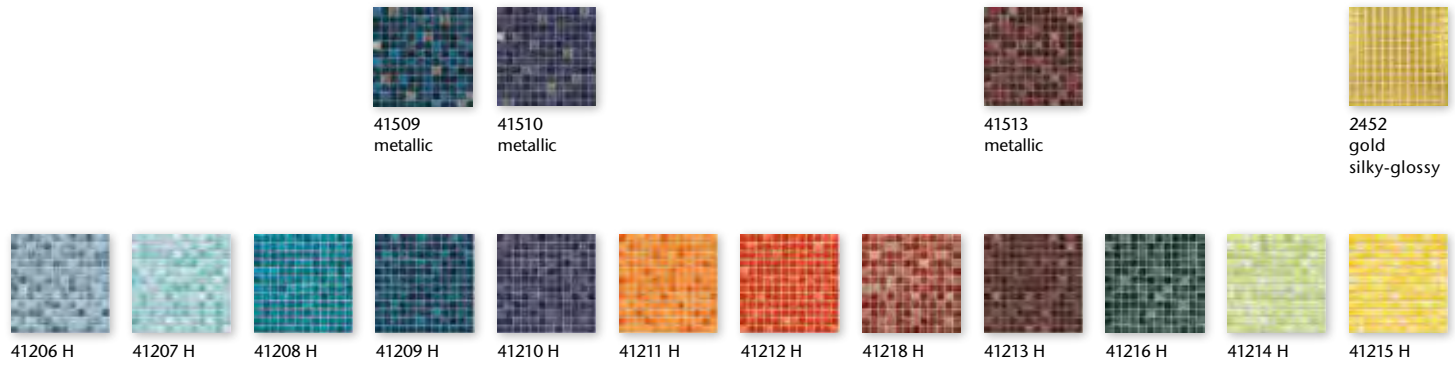

Mosaic 2.5 x 2.5 cm, 1 x 1 in

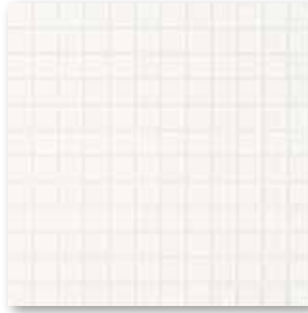

Mosaic sheet 30 x 30 cm, 12 x 12 in snow white, smooth,
Mosaic sheet 30 x 30 cm, 12 x 12 in snow white, smooth, R10/B

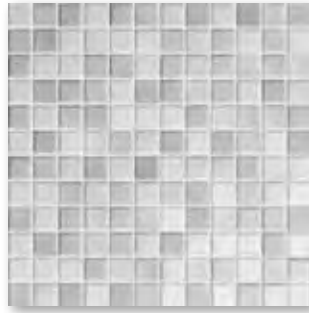

Mosaic sheet 30 x 30 cm, 12 x 12 in white-grey-mix, smooth,
Mosaic sheet 30 x 30 cm, 12 x 12 in white-grey-mix, smooth, R10/B

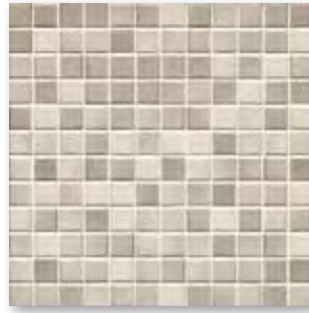

Mosaic sheet 30 x 30 cm, 12 x 12 in desert sand-mix, smooth,
Mosaic sheet 30 x 30 cm, 12 x 12 in desert sand-mix, smooth, R10/B



Mosaic sheet 30 x 30 cm, 12 x 12 in taupe-mix, smooth,
Mosaic sheet 30 x 30 cm, 12 x 12 in taupe-mix, smooth, R10/B



Mosaic sheet 30 x 30 cm, 12 x 12 in white grey-mix, smooth,
Mosaic sheet 30 x 30 cm, 12 x 12 in white grey-mix, smooth, R10/B

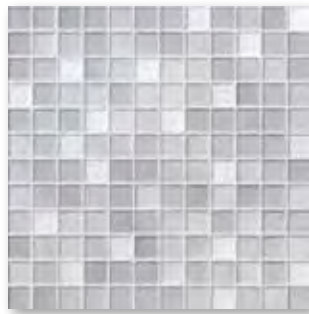

Mosaic sheet 30 x 30 cm, 12 x 12 in silver grey-mix, smooth,
Mosaic sheet 30 x 30 cm, 12 x 12 in silver grey-mix, smooth, R10/B

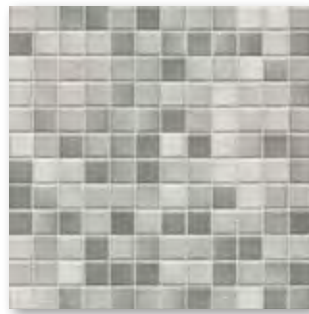

Mosaic sheet 30 x 30 cm, 12 x 12 in light grey-mix, smooth,
Mosaic sheet 30 x 30 cm, 12 x 12 in light grey-mix, smooth, R10/B



Mosaic sheet 30 x 30 cm, 12 x 12 in medium grey-mix, smooth,
Mosaic sheet 30 x 30 cm, 12 x 12 in medium grey-mix, smooth, R10/B

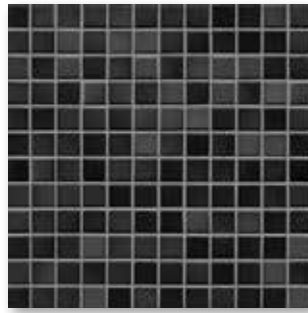

Mosaic sheet 30 x 30 cm, 12 x 12 in midnight black-mix, smooth,
Mosaic sheet 30 x 30 cm, 12 x 12 in midnight black-mix, smooth, R10/B



Mosaic sheet 30 x 30 cm, 12 x 12 in graphite black-mix, smooth,
Mosaic sheet 30 x 30 cm, 12 x 12 in graphite black-mix, smooth, R10/B



Mosaic sheet 30 x 30 cm, 12 x 12 in deep blue-mix, smooth,
Mosaic sheet 30 x 30 cm, 12 x 12 in deep blue-mix, smooth, R10/B

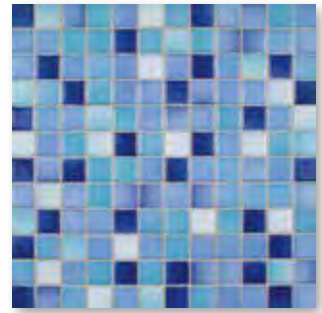

Mosaic sheet 30 x 30 cm, 12 x 12 in caribbean blue-mix, smooth,
Mosaic sheet 30 x 30 cm, 12 x 12 in caribbean blue-mix, smooth, R10/B

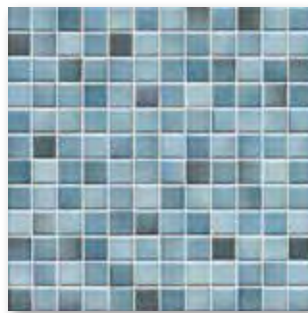

Mosaic sheet 30 x 30 cm, 12 x 12 in denim blue-mix, smooth,
Mosaic sheet 30 x 30 cm, 12 x 12 in denim blue-mix, smooth, R10/B

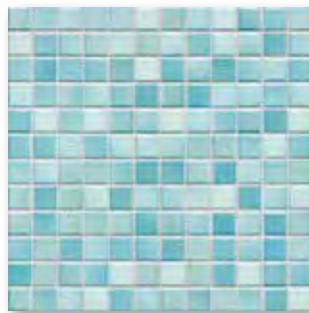

Mosaic sheet 30 x 30 cm, 12 x 12 in light blue-mix, smooth,
Mosaic sheet 30 x 30 cm, 12 x 12 in light blue-mix, smooth, R10/B

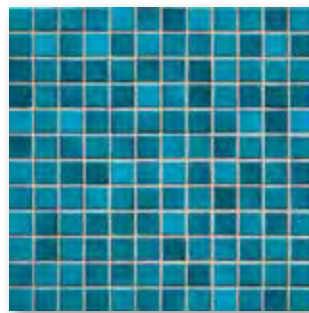

Mosaic sheet 30 x 30 cm, 12 x 12 in pacific blue-mix, smooth,
Mosaic sheet 30 x 30 cm, 12 x 12 in pacific blue-mix, smooth, R10/B

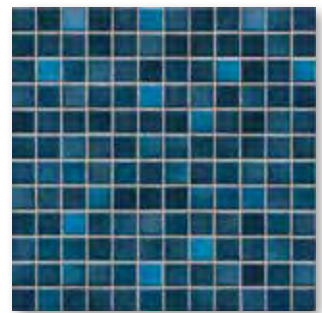

Mosaic sheet 30 x 30 cm, 12 x 12 in midnight blue-mix, smooth,
Mosaic sheet 30 x 30 cm, 12 x 12 in midnight blue-mix, smooth, R10/B



Mosaic sheet 30 x 30 cm, 12 x 12 in
vivid violet-mix, smooth,
Mosaic sheet 30 x 30 cm, 12 x 12 in
vivid violet-mix, smooth, R10/B

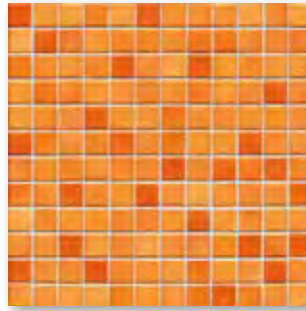

Mosaic sheet 30 x 30 cm, 12 x 12 in
sunset-orange-mix, smooth,
Mosaic sheet 30 x 30 cm, 12 x 12 in
sunset-orange-mix, smooth, R10/B

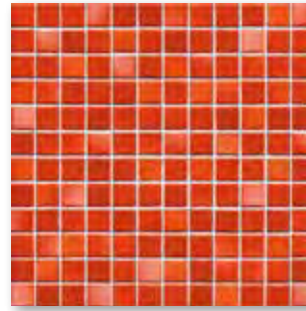

Mosaic sheet 30 x 30 cm, 12 x 12 in
coral red-mix, smooth,
Mosaic sheet 30 x 30 cm, 12 x 12 in
coral red-mix, smooth, R10/B

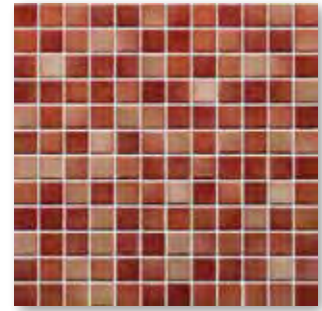

Mosaic sheet 30 x 30 cm, 12 x 12 in
brick red-mix, smooth,
Mosaic sheet 30 x 30 cm, 12 x 12 in
brick red-mix, smooth, R10/B

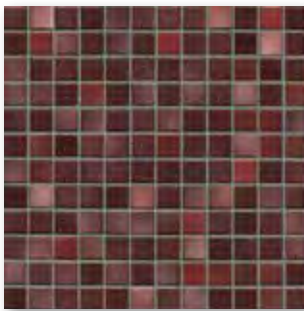

Mosaic sheet 30 x 30 cm, 12 x 12 in
mystic-red-mix, smooth,
Mosaic sheet 30 x 30 cm, 12 x 12 in
mystic-red-mix, smooth, R10/B



Mosaic sheet 30 x 30 cm, 12 x 12 in
forest green-mix, smooth,
Mosaic sheet 30 x 30 cm, 12 x 12 in
forest green-mix, smooth, R10/B

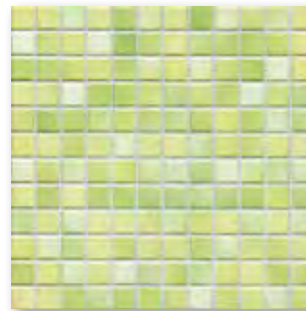

Mosaic sheet 30 x 30 cm, 12 x 12 in
lime green-mix, smooth,
Mosaic sheet 30 x 30 cm, 12 x 12 in
lime green-mix, smooth, R10/B

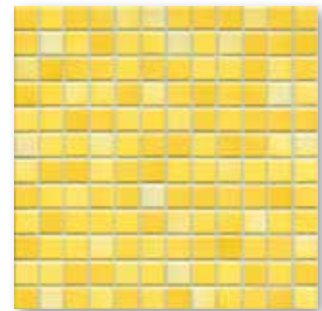

Mosaic sheet 30 x 30 cm, 12 x 12 in
sunshine yellow-mix, smooth,
Mosaic sheet 30 x 30 cm, 12 x 12 in
sunshine yellow-mix, smooth, R10/B

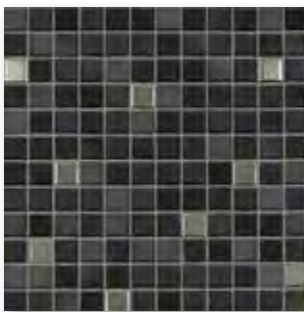

Mosaic sheet 30 x 30 cm, 12 x 12 in
midnight black-mix metallic, smooth

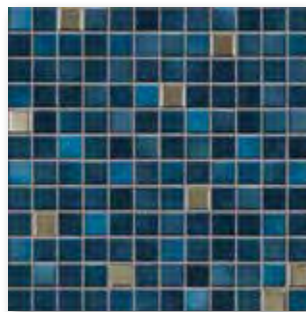

Mosaic sheet 30 x 30 cm, 12 x 12 in
midnight blue-mix metallic, smooth

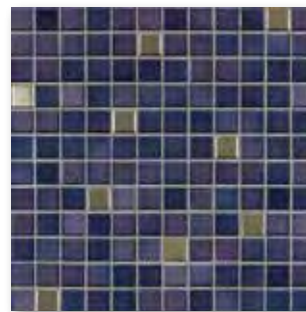

Mosaic sheet 30 x 30 cm, 12 x 12 in
vivid violet-mix metallic, smooth

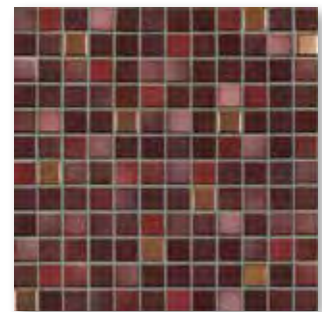

Mosaic sheet 30 x 30 cm, 12 x 12 in
mystic red-mix metallic, smooth

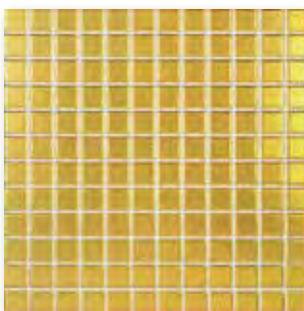

Mosaic sheet 30 x 30 cm, 12 x 12 in,
gold, smooth*

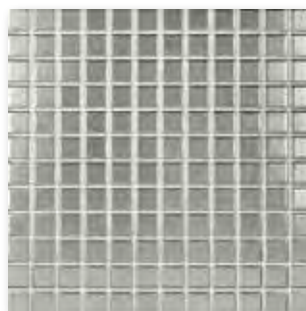

Mosaic sheet 30 x 30 cm, 12 x 12 in,
platin, smooth*

* To prevent the abrasion of the surface coating, laying on the floor or exposure to any comparable stress must be absolutely avoided.

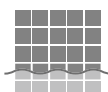

Mosaics glued thermoplastically on back of AGROB BUCHTAL can be used not only in dry zones but also without any problems in underwater areas (e.g. swimming pools/whirlpools) as well as in permanently wet areas (e.g. pool surrounds/showers).

Project: Indoor swimming pool / Location: Oberuzwil, Switzerland / Architect: Hunziker Betatech AG / Series: Fresh / Photo: Adriano Faragulo



Color gradient
2.5 x 2.5 cm, 1 x 1 in



41520H
aqua glossy

More examples

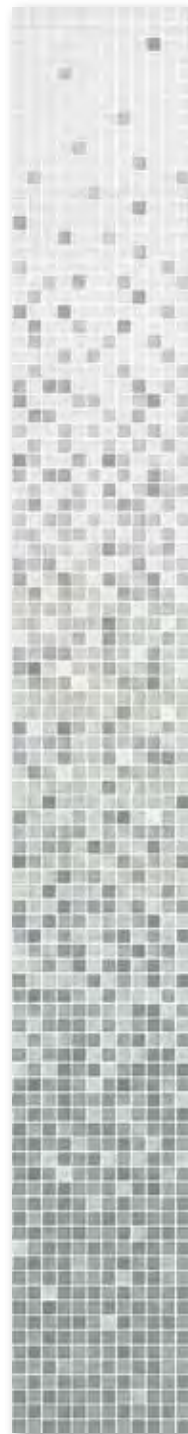

The colors of Fresh can be randomly replaced in the standard color gradient without extra charge. We will be pleased to check an individual design of color gradients with regard to dimensions and color combinations as customized production.

production size without external joint:
297 x 2376 x 6.5 mm

Do you already know our Mosaic Designer at our website
www.agrob-buchtal.de?

There, you will have the possibility of designing your individual color gradients, mosaic compositions and the laying of pictures.



Mosaic 5 x 5 cm, 2 x 2 in, non-slip



Mosaic sheet 30 x 30 cm, 12 x 12 in
snow white, smooth, R10/B,
Mosaic sheet 30 x 30 cm, 12 x 12 in
snow white, smooth, R11/C



Mosaic sheet 30 x 30 cm, 12 x 12 in
warm grey-mix, smooth, R10/B,
Mosaic sheet 30 x 30 cm, 12 x 12 in
warm grey-mix, smooth, R11/C



Mosaic sheet 30 x 30 cm, 12 x 12 in
desert sand-mix, smooth, R10/B,
Mosaic sheet 30 x 30 cm, 12 x 12 in
desert sand-mix, smooth, R11/C



Mosaic sheet 30 x 30 cm, 12 x 12 in
taupe-mix, smooth, R10/B,
Mosaic sheet 30 x 30 cm, 12 x 12 in
taupe-mix, smooth, R11/C



Mosaic sheet 30 x 30 cm, 12 x 12 in
white grey-mix, smooth, R10/B



Mosaic sheet 30 x 30 cm, 12 x 12 in
silver grey-mix, smooth, R10/B



Mosaic sheet 30 x 30 cm, 12 x 12 in
light grey-mix, smooth, R10/B,
Mosaic sheet 30 x 30 cm, 12 x 12 in
light grey-mix, smooth, R11/C

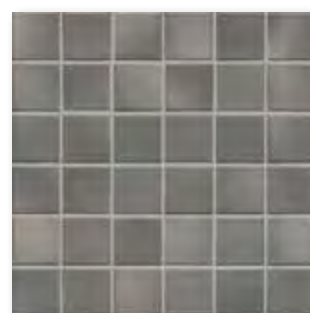

Mosaic sheet 30 x 30 cm, 12 x 12 in
medium grey-mix, smooth, R10/B,
Mosaic sheet 30 x 30 cm, 12 x 12 in
medium grey-mix, smooth, R11/C



Mosaic sheet 30 x 30 cm, 12 x 12 in
midnight black-mix, smooth, R10/B,
Mosaic sheet 30 x 30 cm, 12 x 12 in
midnight black-mix, smooth, R11/C



Mosaic sheet 30 x 30 cm, 12 x 12 in
graphite black-mix, smooth, R10/B



Mosaic sheet 30 x 30 cm, 12 x 12 in
deep blue-mix, smooth, R10/B

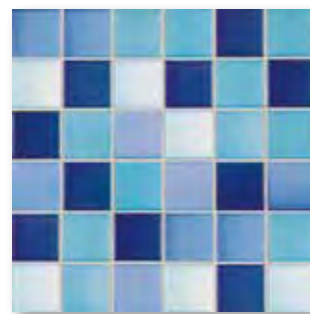

Mosaic sheet 30 x 30 cm, 12 x 12 in
caribbean blue-mix, smooth, R10/B

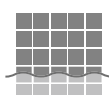

Mosaics glued thermoplastically on back of AGROB BUCHTAL can be used not only in dry zones but also without any problems in underwater areas (e.g. swimming pools/whirlpools) as well as in permanently wet areas (e.g. pool surrounds/showers).



Mosaic sheet 30 x 30 cm, 12 x 12 in denim blue-mix, smooth, R10/B,
Mosaic sheet 30 x 30 cm, 12 x 12 in denim blue-mix, smooth, R11/C

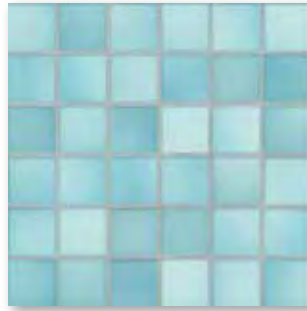

Mosaic sheet 30 x 30 cm, 12 x 12 in light blue-mix, smooth, R10/B,
Mosaic sheet 30 x 30 cm, 12 x 12 in light blue-mix, smooth, R11/C

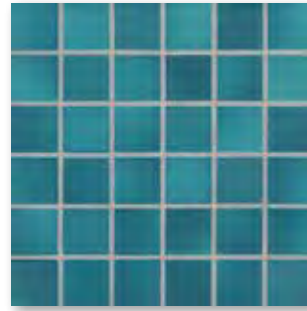

Mosaic sheet 30 x 30 cm, 12 x 12 in pacific blue-mix, smooth, R10/B,
Mosaic sheet 30 x 30 cm, 12 x 12 in pacific blue-mix, smooth, R11/C

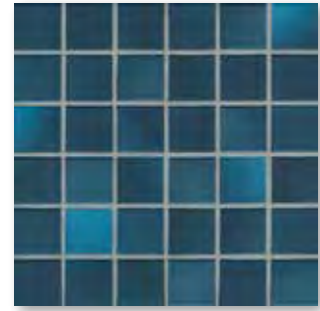

Mosaic sheet 30 x 30 cm, 12 x 12 in midnight blue-mix, smooth, R10/B,
Mosaic sheet 30 x 30 cm, 12 x 12 in midnight blue-mix, smooth, R11/C



Mosaic sheet 30 x 30 cm, 12 x 12 in vivid violet-mix, smooth, R10/B,
Mosaic sheet 30 x 30 cm, 12 x 12 in vivid violet-mix, smooth, R11/C

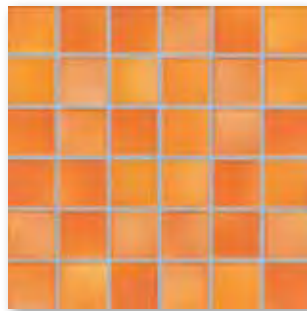

Mosaic sheet 30 x 30 cm, 12 x 12 in sunset orange-mix, smooth, R10/B,
Mosaic sheet 30 x 30 cm, 12 x 12 in sunset orange-mix, smooth, R11/C

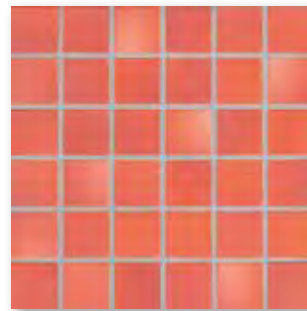

Mosaic sheet 30 x 30 cm, 12 x 12 in mystic red-mix, smooth, R10/B,
Mosaic sheet 30 x 30 cm, 12 x 12 in coral red-mix, smooth, R11/C



Mosaic sheet 30 x 30 cm, 12 x 12 in brick red-mix, smooth, R10/B

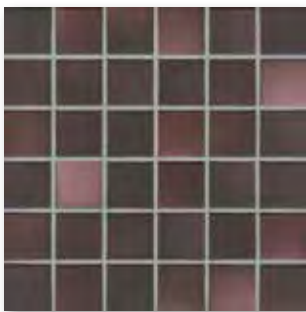

Mosaic sheet 30 x 30 cm, 12 x 12 in mystic red-mix, smooth, R10/B,
Mosaic sheet 30 x 30 cm, 12 x 12 in mystic red-mix, smooth, R11/C



Mosaic sheet 30 x 30 cm, 12 x 12 in forest green-mix, smooth, R10/B



Mosaic sheet 30 x 30 cm, 12 x 12 in lime green-mix, smooth, R10/B,
Mosaic sheet 30 x 30 cm, 12 x 12 in lime green-mix, smooth, R11/C

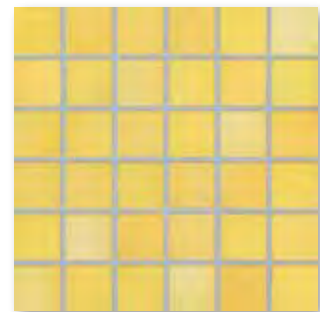

Mosaic sheet 30 x 30 cm, 12 x 12 in sunshine yellow-mix, smooth, R10/B,
Mosaic sheet 30 x 30 cm, 12 x 12 in sunshine yellow-mix, smooth, R11/C

Mosaic

Color
gradient¹

2.5 x 2.5 cm

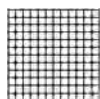

2.5 x 2.5 cm



Mosaic. glued
thermoplastically
on back
Sheet: 297 x 297 mm

Mosaic. glued
thermoplastically
on back
Sheet: 297 x 297 mm



Nom. dim. - cm/in	2.5 x 2.5 / 1 x 1	2.5 x 2.5 / 1 x 1				
Work size	23 x 23 x 6.5 mm	23 x 23 x 6.5 mm				
Surface	smooth, glossy	smooth, glossy				
m ² - pieces	11 sheets	11 sheets				
m ² - kg	12.100					
Bundle - pieces	11 sheets	8 sheets				
Bundle - m ²	1.000	0.800				
Bundle - kg	12.100	8.800				
Pallet - m ²	48.000					
Pallet - kg	580.800					
Product standard	Blb	Blb				
Slip resistance						
Stress group	1 - 2	1 - 2				
snow white	3 41200H Price gr. A229 (m ²)					
desert sand-mix	3 41201H Price gr. A229 (m ²)					
taupe-mix	3 41202H Price gr. A229 (m ²)					
light grey-mix	3 41203H Price gr. A229 (m ²)					
medium grey-mix	3 41204H Price gr. A229 (m ²)					
midnight black-mix	2 41205H Price gr. A229 (m ²)					
denim blue-mix	3 41206H Price gr. A250 (m ²)					
light blue-mix	3 41207H Price gr. A250 (m ²)					
pacific blue-mix	3 41208H Price gr. A250 (m ²)					
midnight blue-mix	3 41209H Price gr. A250 (m ²)					
vivid violet-mix	2 41210H Price gr. A250 (m ²)					
sunset orange-mix	3 41211H Price gr. A250 (m ²)					
coral red-mix	3 41212H Price gr. A250 (m ²)					
mystic red-mix	2 41213H Price gr. A250 (m ²)					
lime green-mix	3 41214H Price gr. A250 (m ²)					
sunshine yellow-mix	4 41215H Price gr. A250 (m ²)					
aqua glossy	3	41520H Price gr. A750 (pce.)				



¹ Work size without external joint: 297 x 2376 mm
The indicated price refers to the color gradient = 8 sheets
Color gradients can be designed individually. We would be delighted to examine the possibility of such customized production in individual cases.

All products: Color Shade Variation V2

Mosaic

2.5 x 2.5 cm

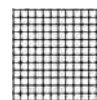

Mosaic, glued
thermoplastically
on back

Sheet: 297 x 297 mm



						2.5 x 2.5 / 1 x 1	Nom. dim. - cm/in
						23 x 23 x 6.5 mm	Work size
						smooth, glossy	Surface
						11 sheets	m ² - pieces
						12.100	m ² - kg
						11 sheets	Bundle - pieces
						1.000	Bundle - m ²
						12.100	Bundle - kg
						48.000	Pallet - m ²
						580.800	Pallet - kg
						Blb	Product standard
							Slip resistance
						1 - 2	Stress group
						41216H	2
						Price gr. A250 (m ²)	
						41217H	2
						Price gr. A250 (m ²)	
						41218H	2
						Price gr. A250 (m ²)	
						41219H	3
						Price gr. A250 (m ²)	
						41220H	3
						Price gr. A250 (m ²)	
						41221H	2
						Price gr. A250 (m ²)	
						41222H	2
						Price gr. A250 (m ²)	
						41223H	2
						Price gr. A250 (m ²)	
						41505	midnight black-mix
						Price gr. A458 (pce.)	metallic glossy
						41509	midnight blue-mix
						Price gr. A458 (pce.)	metallic glossy
						41510	vivid violet-mix
						Price gr. A458 (pce.)	metallic glossy
						41513¹	mystic red-mix
						Price gr. A458 (pce.)	metallic glossy
						2452²	gold
						Price gr. A394 (m ²)	silk-glossy
						2455²	platinum
						Price gr. A394 (m ²)	silk-glossy

¹ Not or only to a limited extent resistant to acids and alkalis.



² To prevent the abrasion of the surface coating, laying on the floor or exposure to any comparable stress must be absolutely avoided.

All products: Color Shade Variation V2
Exception: gold; platinum: V1

Mosaic non-slip

2.5 x 2.5 cm

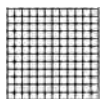

Mosaic, glued
thermoplastically
on back
Sheet: 297 x 297 mm

5 x 5 cm

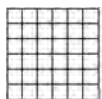

Mosaic, glued
thermoplastically
on back
Sheet: 297 x 297 mm

5 x 5 cm

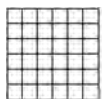

Mosaic, glued
thermoplastically
on back
Sheet: 297 x 297 mm



Nom. dim. - cm/in	2.5 x 2.5 / 1 x 1	5 x 5 / 2 x 2	5 x 5 / 2 x 2				
Work size	23 x 23 x 6.5 mm	47 x 47 x 6.5 mm	47 x 47 x 6.5 mm				
Surface	smooth, matt	smooth, matt	smooth, matt				
m ² - pieces	10 sheets	11 sheets	11 sheets				
m ² - kg	12.060	12.331	12.331				
Bundle - pieces	11 sheets	11 sheets	11 sheets				
Bundle - m ²	1.000	1.000	1.000				
Bundle - kg	12.100	12.331	12.331				
Pallet - m ²	48.000	64.000	64.000				
Pallet - kg	580.800	789.184	789.184				
Product standard	B1b	B1b	B1b				
Slip resistance	R10/B	R10/B	R11/C				
Stress group	1 - 2	1 - 2	1 - 2				
	4	4	4				
snow white	41300H Price gr. A238 (m ²)	41400H-73 Price gr. A196 (m ²)	41420H Price gr. A211 (m ²)				
desert sand-mix	41301H Price gr. A238 (m ²)	41401H-73 Price gr. A196 (m ²)	41421H Price gr. A211 (m ²)				
taupe-mix	41302H Price gr. A238 (m ²)	41402H-73 Price gr. A196 (m ²)	41422H Price gr. A211 (m ²)				
light grey-mix	41303H Price gr. A238 (m ²)	41403H-73 Price gr. A196 (m ²)	41423H Price gr. A211 (m ²)				
medium grey-mix	41304H Price gr. A238 (m ²)	41404H-73 Price gr. A196 (m ²)	41424H Price gr. A211 (m ²)				
midnight black-mix	41305H Price gr. A238 (m ²)	41405H-73 Price gr. A196 (m ²)	41425H Price gr. A211 (m ²)				
denim blue-mix	41306H Price gr. A259 (m ²)	41406H Price gr. A217 (m ²)	41426H Price gr. A229 (m ²)				
light blue-mix	41307H Price gr. A259 (m ²)	41407H Price gr. A217 (m ²)	41427H Price gr. A229 (m ²)				
pacific blue-mix	41308H Price gr. A259 (m ²)	41408H Price gr. A217 (m ²)	41428H Price gr. A229 (m ²)				
midnight blue-mix	41309H Price gr. A259 (m ²)	41409H Price gr. A217 (m ²)	41429H Price gr. A229 (m ²)				
vivid violet-mix	41310H Price gr. A259 (m ²)	41410H Price gr. A217 (m ²)	41430H Price gr. A229 (m ²)				
sunset orange-mix	41311H Price gr. A259 (m ²)	41411H Price gr. A217 (m ²)	41431H Price gr. A229 (m ²)				
coral red-mix	41312H Price gr. A259 (m ²)	41412H Price gr. A217 (m ²)	41432H Price gr. A229 (m ²)				
mystic red-mix	41313H Price gr. A259 (m ²)	41413H Price gr. A217 (m ²)	41433H Price gr. A229 (m ²)				
lime green-mix	41314H Price gr. A259 (m ²)	41414H Price gr. A217 (m ²)	41434H Price gr. A229 (m ²)				
sunshine yellow-mix	41315H Price gr. A259 (m ²)	41415H Price gr. A217 (m ²)	41435H Price gr. A229 (m ²)				
forest green mix	41316H Price gr. A259 (m ²)	41450H Price gr. A217 (m ²)					
deep blue mix	41317H Price gr. A259 (m ²)	41451H Price gr. A217 (m ²)					
brick red mix	41318H Price gr. A259 (m ²)	41452H Price gr. A217 (m ²)					
silver grey mix	41319H Price gr. A259 (m ²)	41453H Price gr. A217 (m ²)					
warm grey mix	41320H Price gr. A259 (m ²)	41454H Price gr. A217 (m ²)					
white grey mix	41321H Price gr. A259 (m ²)	41455H Price gr. A217 (m ²)					
carribbean blue mix	41322H Price gr. A259 (m ²)	41456H Price gr. A217 (m ²)					
graphite black mix	41323H Price gr. A259 (m ²)	41457H Price gr. A217 (m ²)					



All products: Color Shade Variation V2



Project: Indoor swimming pool Höxter, Germany / Architect: Hooper Architects / Series: Fresh, Quarzit / Photo: Jochen Stüber







Homage to craftsmanship

The Karl mosaic collection introduced only a few years ago has been so successful that it has now been complemented not only by a modern 10 x 25 oblong format. The color spectrum of Karl has also been enlarged by five new colors. All in all, Karl reinterprets old craftsmanship. With original-looking glazes and a special recipe of the raw materials. In this way, an individual tile pattern is created for each tile during firing. As surface covering, Karl radiates authentic and elementary appeal. With associations of the simple life and the focus on the essential. The glazed variant is recommended for the design of walls; the stone-matt version with R10/B slip resistance for floors. The Stories series is a suitable floor tile.

Mosaic 2.5 x 2.5 cm, 1 x 1 in



*Mosaic sheet 30 x 30 cm, 12 x 12 in white structured,
Mosaic sheet 30 x 30 cm, 12 x 12 in white, structured, R10/B*



*Mosaic sheet 30 x 30 cm, 12 x 12 in nude, structured,
Mosaic sheet 30 x 30 cm, 12 x 12 in nude, structured, R10/B*

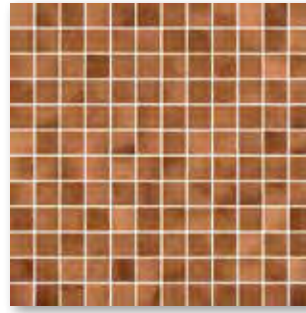

*Mosaic sheet 30 x 30 cm, 12 x 12 in terra, structured,
Mosaic sheet 30 x 30 cm, 12 x 12 in terra, structured, R10/B*

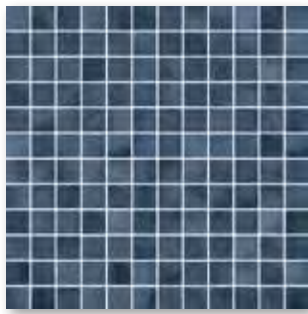

*Mosaic sheet 30 x 30 cm, 12 x 12 in indigo, structured,
Mosaic sheet 30 x 30 cm, 12 x 12 in indigo, structured, R10/B*

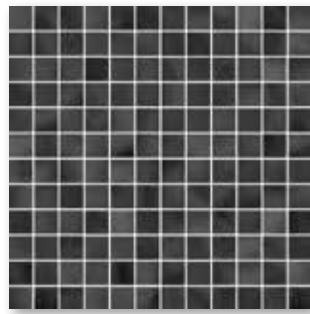

*Mosaic sheet 30 x 30 cm, 12 x 12 in black, structured,
Mosaic sheet 30 x 30 cm, 12 x 12 in black, structured, R10/B*

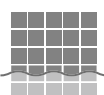

Mosaics glued thermoplastically on back of AGROB BUCHTAL can be used not only in dry zones but also without any problems in underwater areas (e.g. swimming pools/whirlpools) as well as in permanently wet areas (e.g. pool surrounds/showers).

Mosaic 10 x 10 cm, 4 x 4 in



Mosaic sheet 30 x 30 cm, 12 x 12 in white, structured,
Mosaic sheet 30 x 30 cm, 12 x 12 in white, structured, R10/B



Mosaic sheet 30 x 30 cm, 12 x 12 in nude, structured,
Mosaic sheet 30 x 30 cm, 12 x 12 in nude, structured, R10/B

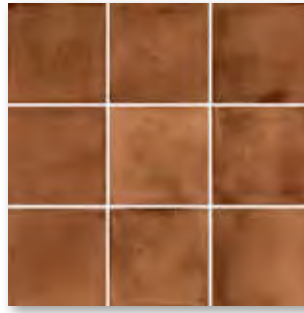

Mosaic sheet 30 x 30 cm, 12 x 12 in terra, structured,
Mosaic sheet 30 x 30 cm, 12 x 12 in terra, structured, R10/B

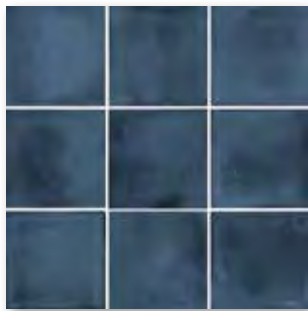

Mosaic sheet 30 x 30 cm, 12 x 12 in indigo, structured,
Mosaic sheet 30 x 30 cm, 12 x 12 in indigo, structured, R10/B

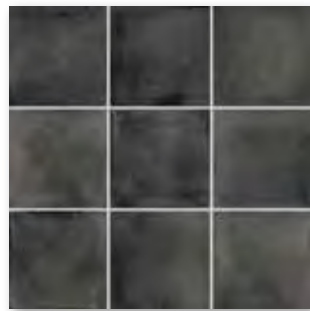

Mosaic sheet 30 x 30 cm, 12 x 12 in black, structured,
Mosaic sheet 30 x 30 cm, 12 x 12 in black, structured, R10/B



Mosaic sheet 30 x 30 cm, 12 x 12 in forest, structured,
Mosaic sheet 30 x 30 cm, 12 x 12 in forest, structured, R10/B



Mosaic sheet 30 x 30 cm, 12 x 12 in grey green, structured,
Mosaic sheet 30 x 30 cm, 12 x 12 in grey green, structured, R10/B

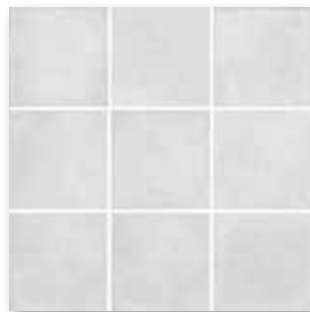

Mosaic sheet 30 x 30 cm, 12 x 12 in grey, structured,
Mosaic sheet 30 x 30 cm, 12 x 12 in grey, structured, R10/B



Mosaic sheet 30 x 30 cm, 12 x 12 in aqua, structured,
Mosaic sheet 30 x 30 cm, 12 x 12 in aqua, structured, R10/B



Mosaic sheet 30 x 30 cm, 12 x 12 in ocean blue, structured,
Mosaic sheet 30 x 30 cm, 12 x 12 in ocean blue, structured, R10/B



Wall tile 10 x 25 cm, 4 x 10 in white, structured



Wall tile 10 x 25 cm, 4 x 10 in nude, structured



Wall tile 10 x 25 cm, 4 x 10 in terra, structured

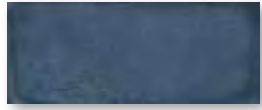

Wall tile 10 x 25 cm, 4 x 10 in indigo, structured

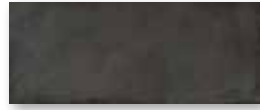

Wall tile 10 x 25 cm, 4 x 10 in black, structured

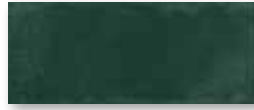

Wall tile 10 x 25 cm, 4 x 10 in forest, structured



Wall tile 10 x 25 cm, 4 x 10 in grey green, structured

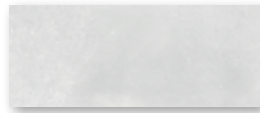

Wall tile 10 x 25 cm, 4 x 10 in grey, structured



Wall tile 10 x 25 cm, 4 x 10 in aqua, structured

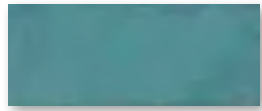

Wall tile 10 x 25 cm, 4 x 10 in ocean blue, structured

Mosaic¹

Wall Tile

2.5 x 2.5 cm

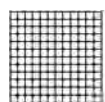

Mosaic, glued thermoplastically on back
Sheet: 297 x 297 mm

2.5 x 2.5 cm

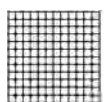

Mosaic, glued thermoplastically on back
Sheet: 297 x 297 mm

10 x 10 cm

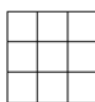

Mosaic, glued thermoplastically on back
Sheet: 297 x 297 mm

10 x 10 cm

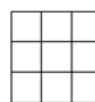

Mosaic, glued thermoplastically on back
Sheet: 297 x 297 mm

10 x 25 cm



	2.5 x 2.5 / 1 x 1	2.5 x 2.5 / 1 x 1	10 x 10 / 4 x 4	10 x 10 / 4 x 4	10 x 25 / 4 x 10	Nom. dim. - cm/in
	23 x 23 x 6.5 mm	23 x 23 x 6.5 mm	97 x 97 x 6.5 mm	97 x 97 x 6.5 mm	97 x 247 x 6.5 mm	Work size
	structured, glossy	structured, matt	structured, glossy	structured, matt	structured, glossy	Surface
	11 sheets	11 sheets	11 sheets	11 sheets	40.000	m ² - pieces
	12.100	12.100	13.101	13.101	12.560	m ² - kg
	11 sheets	11 sheets	11 sheets	11 sheets	27	Bundle - pieces
	1.000	1.000	1.000	1.000	0.675	Bundle - m ²
	12.100	12.100	13.101	13.101	8.478	Bundle - kg
	40.000	40.000	64.000	64.000	86.400	Pallet - m ²
	484.000	484.000	838.464	838.464	1,058.184	Pallet - kg
	Bla (GL)	Bla (UGL)	Bla (GL)	Bla (UGL)	Bla (GL)	Product standard
		R10/B		R10/B		Slip resistance
	1 - 2	1 - 2	1 - 2	1 - 2	1 - 2	Stress group
	47050H	47075H	47250H	47275H	47650H	white
	Price gr. A244 (m ²)	Price gr. A250 (m ²)	Price gr. A148 (m ²)	Price gr. A178 (m ²)	Price gr. A196 (m ²)	
	47051H	47076H	47251H	47276H	47651H	nude
	Price gr. A244 (m ²)	Price gr. A250 (m ²)	Price gr. A148 (m ²)	Price gr. A178 (m ²)	Price gr. A196 (m ²)	
	47052H	47077H	47252H	47277H	47652H	terra
	Price gr. A244 (m ²)	Price gr. A250 (m ²)	Price gr. A148 (m ²)	Price gr. A178 (m ²)	Price gr. A196 (m ²)	
	47053H	47078H	47253H	47278H	47653H	indigo
	Price gr. A244 (m ²)	Price gr. A250 (m ²)	Price gr. A148 (m ²)	Price gr. A178 (m ²)	Price gr. A196 (m ²)	
	47054H	47079H	47254H	47279H	47654H	black
	Price gr. A244 (m ²)	Price gr. A250 (m ²)	Price gr. A148 (m ²)	Price gr. A178 (m ²)	Price gr. A196 (m ²)	
			47255H	47280H	47655H	forest
			Price gr. A148 (m ²)	Price gr. A178 (m ²)	Price gr. A196 (m ²)	
			47256H	47281H	47656H	grey green
			Price gr. A148 (m ²)	Price gr. A178 (m ²)	Price gr. A196 (m ²)	
			47257H	47282H	47657H	grey
			Price gr. A148 (m ²)	Price gr. A178 (m ²)	Price gr. A196 (m ²)	
			47258H	47283H	47658H	aqua
			Price gr. A148 (m ²)	Price gr. A178 (m ²)	Price gr. A196 (m ²)	
			47259H	47284H	47659H	ocean blue
			Price gr. A148 (m ²)	Price gr. A178 (m ²)	Price gr. A196 (m ²)	



All products: Color Shade Variation V3

202 KERAION SPECIAL GLAZES FOR OPERATING THEATRES

Project: Krankenhaus der Barmherzigen Brüder (hospital) / Location: Eisenstadt, Austria / Architect: Matthias Szauer / Series: KerAion Special Glazes for Operating Theatres / Photo: Manfred Seidl





KerAion Special glazes for operating theatres

Ideal for wall coverings in rooms where lasers are used such as e.g. operating theatres. These products perfectly meet the requirements with regard to diffusely reflecting surfaces: incident laser beams are "split up", thus preventing uncontrolled reflection. This is confirmed by the expert opinion of the Laser Medical Centre Berlin and applies to the following types of lasers normally used in medical applications:

- Argon – a typical visible laser
- Nd:YAG – a typical laser in the close-infrared range
- Excimer – a typical UV-laser
- CO₂ – a typical laser in the mid-infrared range

Special advantage of the large model size of 60 x 60 cm: reduced number of joints, therefore easy to clean and hygienic. Perfect complement for the floor: the static electricity conducting panel ELA 10.6 (see page 158), also in model size 60 x 60 cm.



blue



green



grey



light-grey

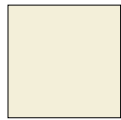

beige



white

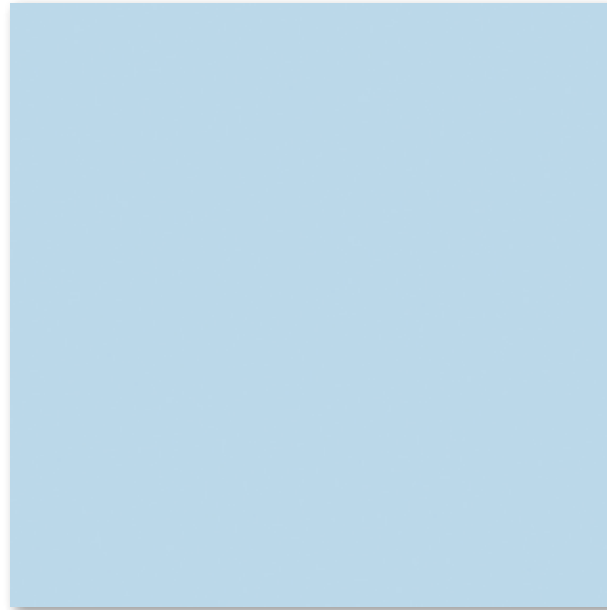

Floor/Wall panels
60 x 60 cm, 24 x 24 in, smooth

The following series is also suitable:

- matt glazes of the series Plural (see page 250)

In the chapter Technical Information
you find the following
additional information about this
mono-colored series:

- NCS Natural Color System
- RAL Color Chart
- Lightness Values

Floor/
Wall Tiles

60 x 60 cm¹

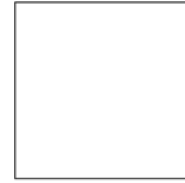

						B600HK		Model number
						60 x 60 / 24 x 24		Nom. dim. - cm/in
						597 x 597 x 8 mm		Work size
						smooth, silky-matt		Surface
						2.780		m ² - pieces
						18.014		m ² - kg
						4		Bundle - pieces
						1.439		Bundle - m ²
						25.920		Bundle - kg
						43.165		Pallet - m ²
						777.600		Pallet - kg
						Alb		Product standard
						2203-B600HK	4	
						Price gr. A256 (m ²)		white
						2204-B600HK	4	
						Price gr. A256 (m ²)		beige
						2205-B600HK	4	
						Price gr. A256 (m ²)		light grey
						2206-B600HK	3	
						Price gr. A256 (m ²)		grey
						2207-B600HK	3	
						Price gr. A256 (m ²)		green
						2208-B600HK	4	
						Price gr. A256 (m ²)		blue

The panels of the series KerAion OP Special Glazes are also available in other sizes (up to the maximum edge length of 120 cm) and glazes. When required, please contact your advisor to customers.

The narrow joints, the large size and the Hytect coating effectively support easy cleaning and a high standard of hygiene.

All products: Color Shade Variation V0



¹ rectified





Studio photo / Series: Loop

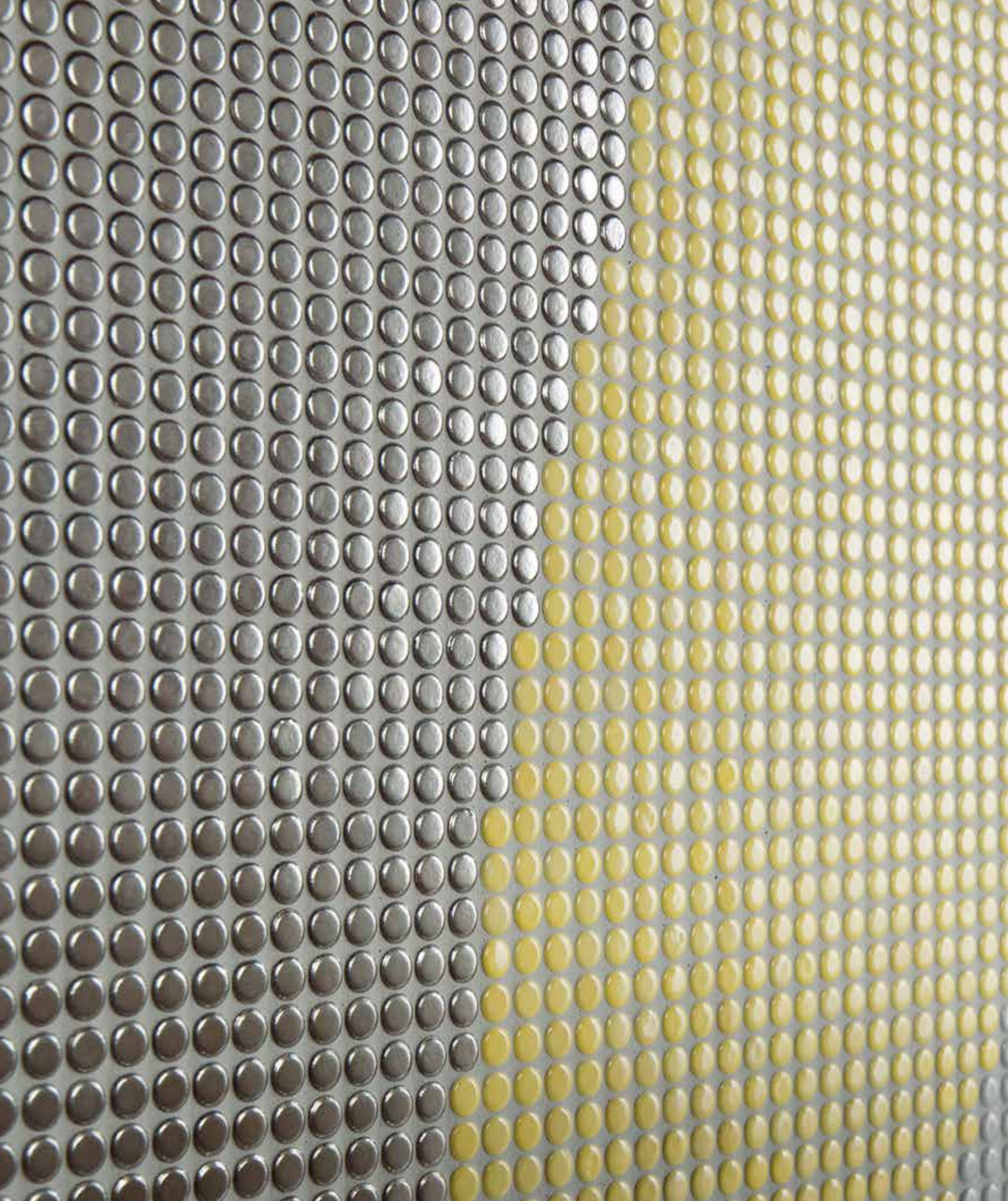



Fine and round

The perfect answer to the trend towards soft, rounded designs is the mosaic Loop. It is available in 15 finely nuanced, high-gloss colors, six of which are also available in a matt, slip-resistant version. This extends the range of applications to showers and other wet areas. In addition to the mosaic with a 2 cm diameter, a 1 cm variant is also available, which conveys a particularly filigree and elegant impression. In contrasting colors, it is also suitable for pictograms, letters, arrows and QR codes. Decorative elements made of square and round mosaic tiles and the Ocean decor with undulating color gradient round off the series.

Mosaic Ø 1 cm, Ø 3/8 in



Mosaic sheet 30 x 30 cm, 12 x 12 in arctic white glossy, smooth

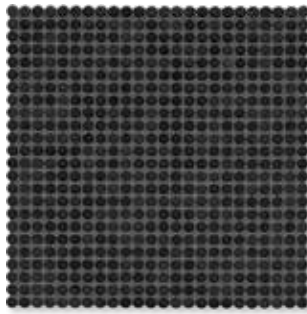

Mosaic sheet 30 x 30 cm, 12 x 12 in night black glossy, smooth



Mosaic sheet 30 x 30 cm, 12 x 12 in light ivory glossy, smooth



Mosaic sheet 30 x 30 cm, 12 x 12 in ivory glossy, smooth



Mosaic sheet 30 x 30 cm, 12 x 12 in light diamond grey glossy, smooth



Mosaic sheet 30 x 30 cm, 12 x 12 in diamond grey glossy, smooth



Mosaic sheet 30 x 30 cm, 12 x 12 in denim glossy, smooth

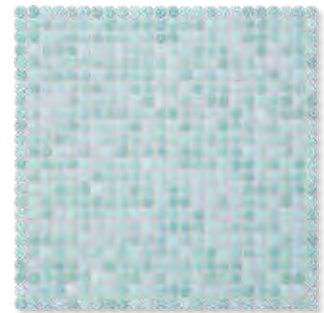

Mosaic sheet 30 x 30 cm, 12 x 12 in light aqua blue glossy, smooth

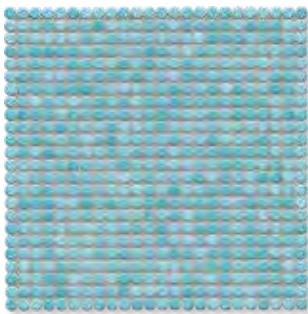

Mosaic sheet 30 x 30 cm, 12 x 12 in aqua blue glossy, smooth

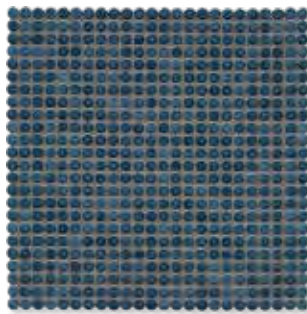

Mosaic sheet 30 x 30 cm, 12 x 12 in steel blue glossy, smooth

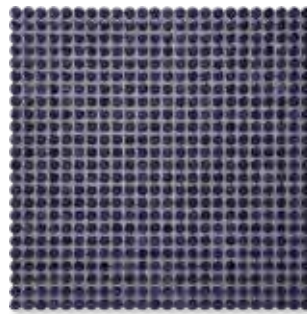

Mosaic sheet 30 x 30 cm, 12 x 12 in dark violet glossy, smooth

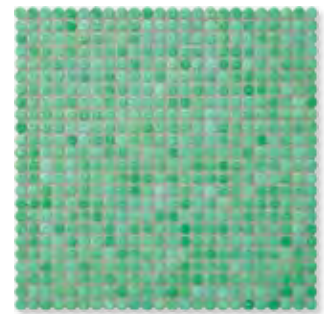

Mosaic sheet 30 x 30 cm, 12 x 12 in sea green glossy, smooth

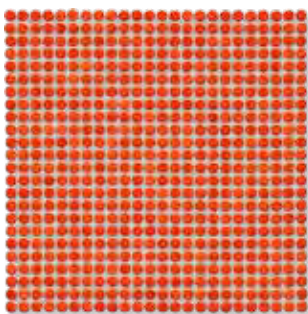

Mosaic sheet 30 x 30 cm, 12 x 12 in coral-red glossy, smooth

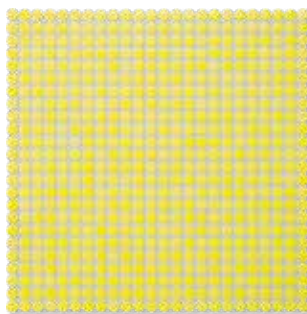

Mosaic sheet 30 x 30 cm, 12 x 12 in lemon-yellow glossy, smooth



Mosaic sheet 30 x 30 cm, 12 x 12 in bronze-metallic glossy, smooth

The products depicted can also be manufactured in other colors. We would be delighted to examine the possibility of such customized production in individual cases.

Mosaic 1 x 1 cm / Ø 1 cm, 3/8 x 3/8 in / Ø 3/8 in

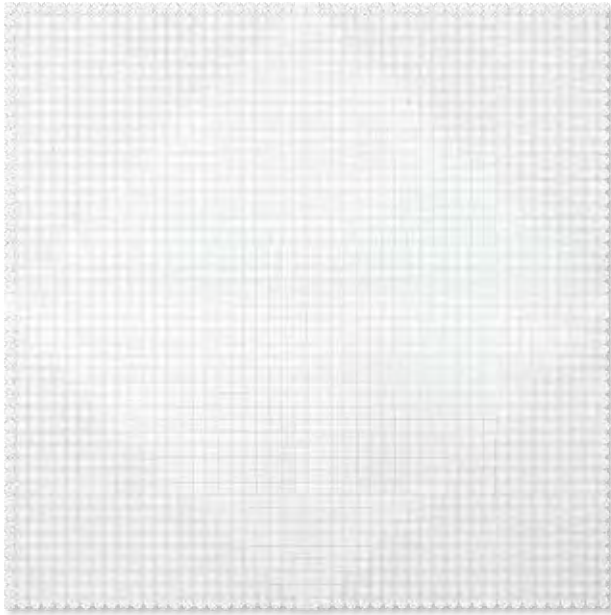

Mosaic sheet 30 x 30 cm, Triangle, arctic white glossy, smooth

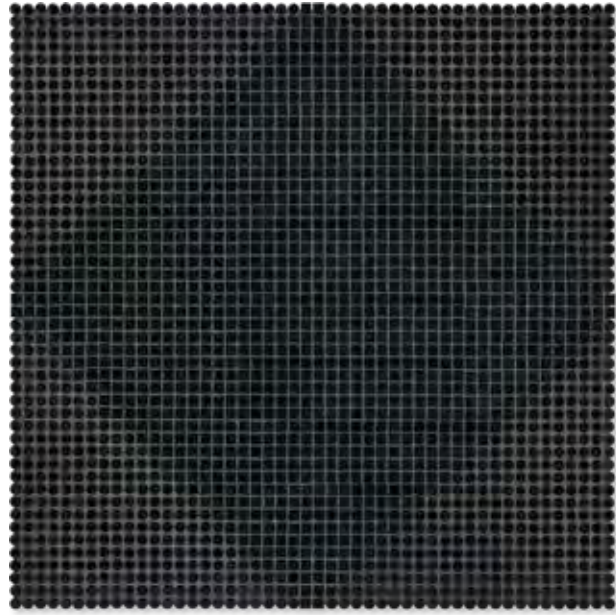

Mosaic sheet 30 x 30 cm, Triangle, night black glossy, smooth

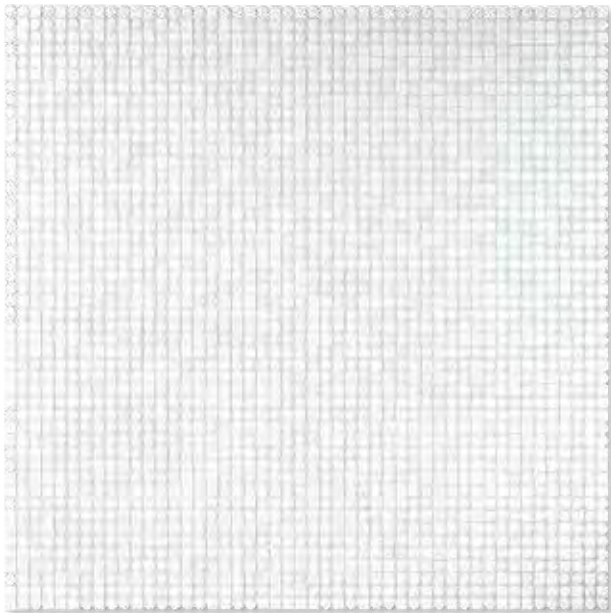

Mosaic sheet 30 x 30 cm, Random Mix, arctic white glossy, smooth

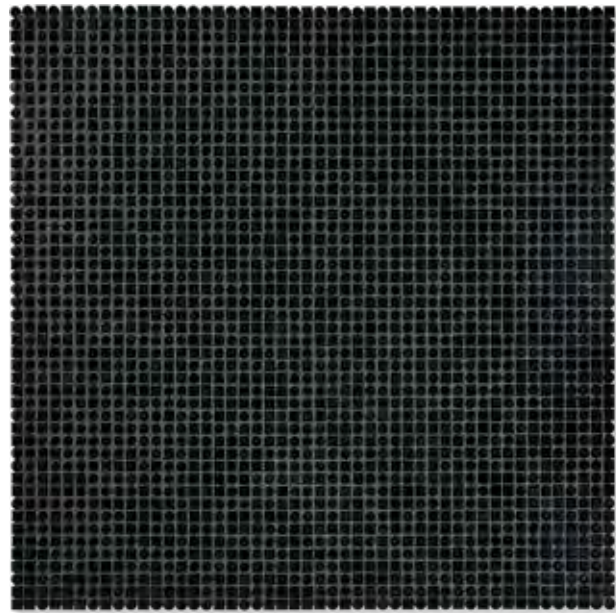

Mosaic sheet 30 x 30 cm, Random Mix, night black glossy, smooth

Production size without external joint 632 x 632 x 6.5 mm

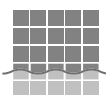

Mosaics glued thermoplastically on back of AGROB BUCHTAL can be used not only in dry zones but also without any problems in underwater areas (e.g. swimming pools/whirlpools) as well as in permanently wet areas (e.g. pool surrounds/showers).

Mosaic 1 x 1 cm / Ø 1 cm, 3/8 x 3/8 in / Ø 3/8 in



Mosaic sheet 30 x 30 cm, Leaves, arctic white glossy, smooth

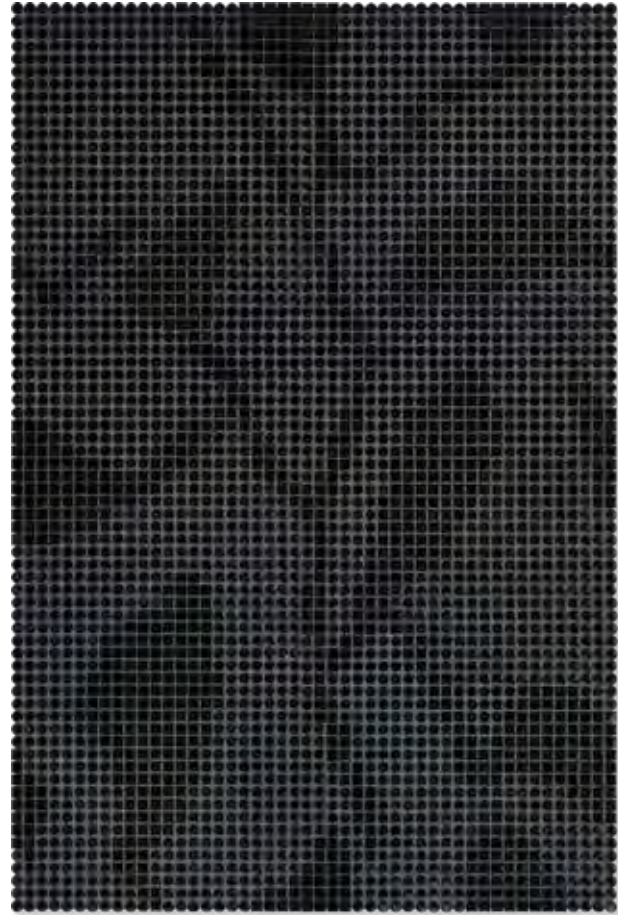

Mosaic sheet 30 x 30 cm, Leaves, night black glossy, smooth

Production size without external joint 632 x 948 x 6.5 mm

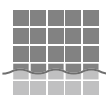

Mosaics glued thermoplastically on back of AGROB BUCHTAL can be used not only in dry zones but also without any problems in underwater areas (e.g. swimming pools/whirlpools) as well as in permanently wet areas (e.g. pool surrounds/showers).

Color gradient
Ø 1 cm, Ø 3/8 in

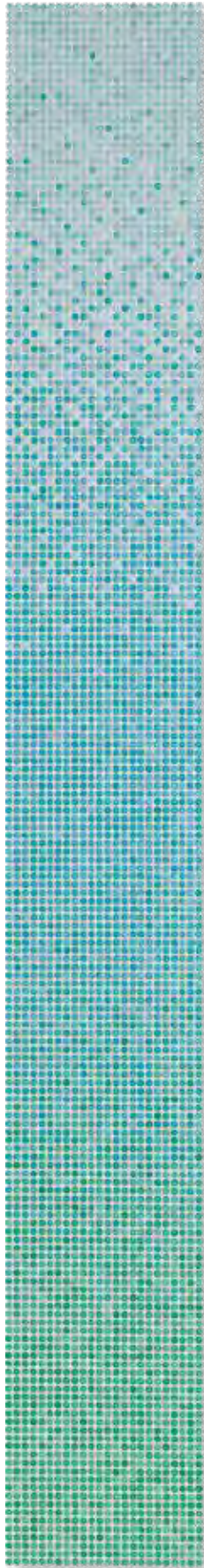

ocean glossy

Color gradient
Ø 2 cm, Ø 6/8 in



ocean glossy

More examples

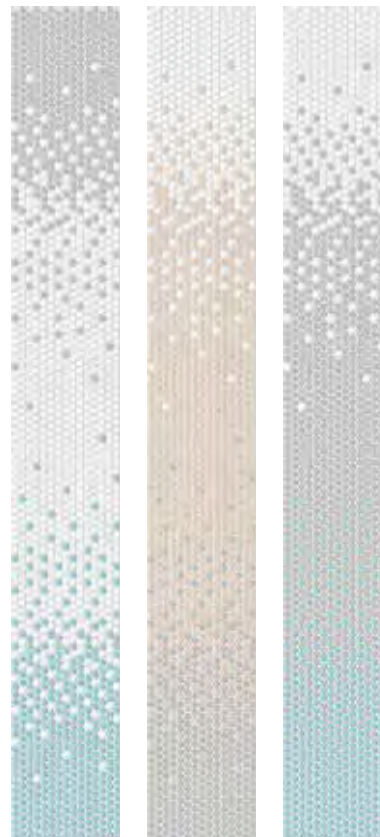
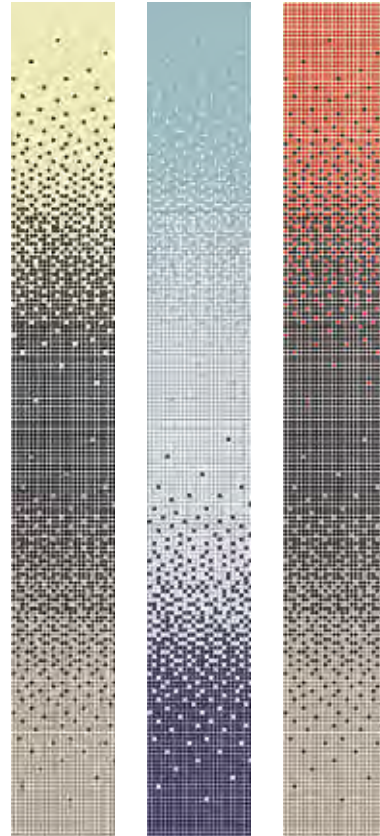

production size without external joint
314 x 2528 x 6.5 mm

The colors of Loop can be randomly replaced in the standard color gradient without extra charge. We will be pleased to check an individual design of color gradients with regard to dimensions and color combinations as customized production.

Do you already know our Mosaic Designer at our website www.agrob-buchtal.de?

There, you will have the possibility of designing your individual color gradients, mosaic compositions and the laying of pictures.

Mosaic Ø 2 cm, Ø 6/8 in



Mosaic sheet 32 x 32 cm, 12.8 x 12.8 in arctic white glossy, smooth
Mosaic sheet 32 x 32 cm, 12.8 x 12.8 in arctic white, smooth, R10/B



Mosaic sheet 32 x 32 cm, 12.8 x 12.8 in night black glossy, smooth
Mosaic sheet 32 x 32 cm, 12.8 x 12.8 in night black, smooth, R10/B



Mosaic sheet 32 x 32 cm, 12.8 x 12.8 in light ivory glossy, smooth
Mosaic sheet 32 x 32 cm, 12.8 x 12.8 in light ivory, smooth, R10/B



Mosaic sheet 32 x 32 cm, 12.8 x 12.8 in ivory glossy, smooth



Mosaic sheet 32 x 32 cm, 12.8 x 12.8 in light diamond grey glossy, smooth
Mosaic sheet 32 x 32 cm, 12.8 x 12.8 in light diamond grey, smooth, R10/B



Mosaic sheet 32 x 32 cm, 12.8 x 12.8 in diamond grey glossy, smooth



Mosaic sheet 32 x 32 cm, 12.8 x 12.8 in denim glossy, smooth



Mosaic sheet 32 x 32 cm, 12.8 x 12.8 in light aqua blue glossy, smooth
Mosaic sheet 32 x 32 cm, 12.8 x 12.8 in light aqua blue, smooth, R10/B



Mosaic sheet 32 x 32 cm, 12.8 x 12.8 in aqua blue glossy, smooth
Mosaic sheet 32 x 32 cm, 12.8 x 12.8 in aqua blue, smooth, R10/B

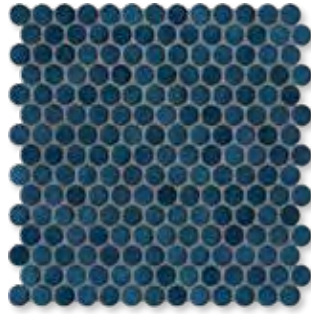

Mosaic sheet 32 x 32 cm, 12.8 x 12.8 in steel blue glossy, smooth



Mosaic sheet 32 x 32 cm, 12.8 x 12.8 in dark violet glossy, smooth



Mosaic sheet 32 x 32 cm, 12.8 x 12.8 in sea green glossy, smooth
Mosaic sheet 32 x 32 cm, 12.8 x 12.8 in sea green, smooth, R10/B

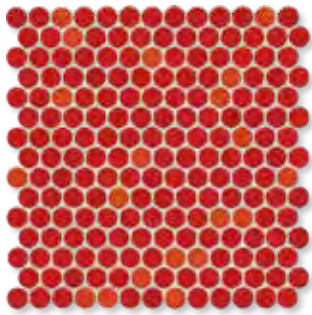

Mosaic sheet 32 x 32 cm, 12.8 x 12.8 in coral-red glossy, smooth

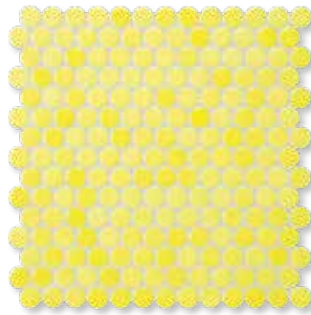

Mosaic sheet 32 x 32 cm, 12.8 x 12.8 in lemon-yellow glossy, smooth



Mosaic sheet 32 x 32 cm, 12.8 x 12.8 in bronze-metallic glossy, smooth

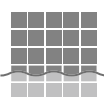

Mosaics glued thermoplastically on back of AGROB BUCHTAL can be used not only in dry zones but also without any problems in underwater areas (e.g. swimming pools/whirlpools) as well as in permanently wet areas (e.g. pool surrounds/showers).

Mosaic

Color gradient

Ø 1 cm

Ø 1 cm¹

Ø 1 cm¹

Ø 1 cm²

Ø 2 cm

Ø 1 cm^{3/5}

Ø 2 cm^{4/5}

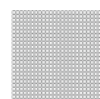
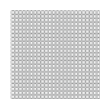

Mosaic, glued thermoplastically on back
Sheet: 316 x 316 mm

Mosaic, glued thermoplastically on back
Sheet: 316 x 316 mm
Triangle

Mosaic, glued thermoplastically on back
Sheet: 316 x 316 mm
Random-Mix

Mosaic, glued thermoplastically on back
Sheet: 316 x 316 mm
Leaves

Mosaic, glued thermoplastically on back
Sheet: 326 x 316 mm

Mosaic, glued thermoplastically on back
Sheet: 316 x 316 mm

Mosaic, glued thermoplastically on back
Sheet: 326 x 316 mm



Ø 1 / 3/8	Ø 1 / 3/8	Ø 1 / 3/8	Ø 1 / 3/8	Ø 2 / 6/8	Ø 1 / Ø 3/8	Ø 2 / 6/8	Stress group	Nom. dim. - cm/in
Ø 12 x 6.5 mm	Ø 12 x 6.5 mm	Ø 12 x 6.5 mm	Ø 12 x 6.5 mm	Ø 22.3 x 6.5 mm	Ø 12 x 6.5 mm	Ø 22.3 x 6.5 mm		
smooth, glossy	smooth, glossy	smooth, glossy	smooth, glossy	smooth, glossy	smooth, glossy	smooth, glossy		Work size
10 sheets				10 sheets				Surface
9.720				11.600				m ² - pieces
10 sheets	4 sheets	4 sheets	6 sheets	10 sheets	8 sheets	8 sheets		m ² - kg
1.000	0.400	0.400	0.600	1.000	0.800	0.800		Bundle - pieces
9.720	4.320	4.320	6.480	11.600	7.776	8.872		Bundle - m ²
24.000				48.000				Bundle - kg
233.280				556.800				Pallet - m ²
Blb	Blb	Blb	Blb	Blb	Blb	Blb		Pallet - kg
40000H	40050H	40052H	40054H	40020H			3	Product standard
Price gr. A382 (m ²)	Price gr. A698 (Set)	Price gr. A698 (Set)	Price gr. A791 (Set)	Price gr. A304 (m ²)				3 arctic white
40001H	40051H	40053H	40055H	40021H			2	glossy
Price gr. A382 (m ²)	Price gr. A698 (Set)	Price gr. A698 (Set)	Price gr. A791 (Set)	Price gr. A304 (m ²)				2 night black
40002H				40022H			3	glossy
Price gr. A382 (m ²)				Price gr. A304 (m ²)				3 light ivory
40003H				40023H			3	glossy
Price gr. A382 (m ²)				Price gr. A304 (m ²)				3 ivory
40004H				40024H			3	glossy
Price gr. A382 (m ²)				Price gr. A304 (m ²)				3 light diamond grey
40005H				40025H			2	glossy
Price gr. A382 (m ²)				Price gr. A304 (m ²)				2 diamond grey
40006H				40026H			3	glossy
Price gr. A382 (m ²)				Price gr. A304 (m ²)				3 denim
40007H				40027H			3	glossy
Price gr. A382 (m ²)				Price gr. A304 (m ²)				3 light aqua blue
40008H				40028H			2	glossy
Price gr. A382 (m ²)				Price gr. A304 (m ²)				2 aqua blue
40009H				40029H			2	glossy
Price gr. A382 (m ²)				Price gr. A304 (m ²)				2 steel blue
40010H				40030H			2	glossy
Price gr. A382 (m ²)				Price gr. A304 (m ²)				2 dark violet
40011H				40031H			3	glossy
Price gr. A382 (m ²)				Price gr. A304 (m ²)				3 sea green
40012H				40032H			2	glossy
Price gr. A382 (m ²)				Price gr. A304 (m ²)				2 coral-red
40013H				40033H			3	glossy
Price gr. A382 (m ²)				Price gr. A304 (m ²)				3 lemon-yellow
40014 ^{6/7}				40034 ^{6/7}			1	glossy
Price gr. A385 (m ²)				Price gr. A346 (m ²)				1 bronze-metallic
					40056H	40057H	2	glossy
					Price gr. A791 (pce.)	Price gr. A750 (pce.)		2 ocean

¹ Work size without external joint: 632 x 632 x 6.5 mm

² Work size without external joint: 632 x 948 x 6.5 mm

³ Work size without external joint: 314 x 2528 x 6.5 mm

⁴ Work size without external joint: 326 x 2528 x 6.5 mm

⁵ The indicated price refers to the color gradient = 8 sheets

⁶ Not or only to a limited extent resistant to acids and alkalis.

⁷ without Hytect

Color gradients can be designed individually. We would be delighted to examine the possibility of such customized production in individual cases.

All products: Color Shade Variation V2



Mosaic non-slip

Ø 2 cm



Mosaic, glued
thermoplastically
on back
Sheet: 326 x 316 mm



Nom. dim. - cm/in	Ø 2 / 6/8						
Work size	Ø 22.3 x 6.5 mm						
Surface	smooth, matt						
m ² - pieces	10 sheets						
m ² - kg	11.600						
Bundle - pieces	10 sheets						
Bundle - m ²	1.000						
Bundle - kg	11.600						
Pallet - m ²	48.000						
Pallet - kg	556.800						
Product standard	Blb						
Slip resistance	R10/B						
	4						
arctic white	40040H Price gr. A313 (m ²)						
night black	2 40041H Price gr. A313 (m ²)						
light ivory	4 40042H Price gr. A313 (m ²)						
light diamond grey	4 40044H Price gr. A313 (m ²)						
aqualight blue	4 40047H Price gr. A313 (m ²)						
aqua blue	3 40048H Price gr. A313 (m ²)						
sea green	3 40071H Price gr. A313 (m ²)						



The products depicted can also be manufactured in other colors. We would be delighted to examine the possibility of such customized production in individual cases.

All products: Color Shade Variation V2

Project: Lintharena / Location: Näfels, Switzerland / Architect: K & L Architekten AG, St. Gallen, Switzerland /
Series: Loop, special composition / Photo: Kim Britt Photography







Possibilities rich in detail

While marble is usually used in large formats, the Marble & More mosaic series captivates with its almost small-scale aesthetics and varied colorfulness. Unlike its natural marble counterpart, this tile is insensitive to aggressive media such as cleaning agents, shampoos and soaps. Slip-resistant variants extend the laying freedom of planners and architects. As Hytect tiles, Marble & More are very easy to clean and they ensure hygiene. In addition, the series is color-coordinated with the Ascona series on the floor and wall.

Mosaic 1 x 1 cm, 3/8 x 3/8 in



Mosaic sheet 30 x 30 cm, 12 x 12 in carrara white, smooth



Mosaic sheet 30 x 30 cm, 12 x 12 in illusion beige, smooth

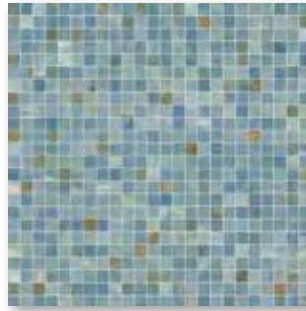

Mosaic sheet 30 x 30 cm, 12 x 12 in cielo, smooth

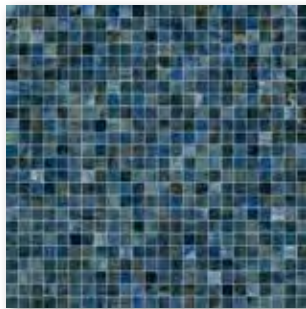

Mosaic sheet 30 x 30 cm, 12 x 12 in labradorit blue, smooth

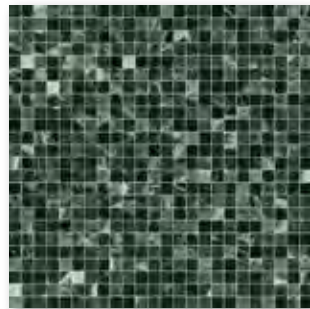

Mosaic sheet 30 x 30 cm, 12 x 12 in verdi alpi, smooth

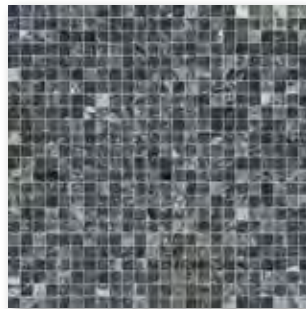

Mosaic sheet 30 x 30 cm, 12 x 12 in illusion dark, smooth

Mosaic 2.5 x 2.5 cm, 1 x 1 in



Mosaic sheet 30 x 30 cm, 12 x 12 in carrara white, smooth,
Mosaic sheet 30 x 30 cm, 12 x 12 in white, smooth, R10/B



Mosaic sheet 30 x 30 cm, 12 x 12 in illusion beige, smooth,
Mosaikbogen 30 x 30 cm illusion beige, smooth, R10/B

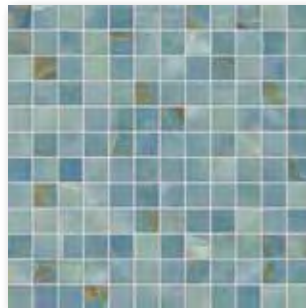

Mosaic sheet 30 x 30 cm, 12 x 12 in cielo, smooth,
Mosaic sheet 30 x 30 cm, 12 x 12 in cielo, smooth, R10/B



Mosaic sheet 30 x 30 cm, 12 x 12 in labradorit blue, smooth,
Mosaic sheet 30 x 30 cm, 12 x 12 in labradorit blue, smooth, R10/B



Mosaic sheet 30 x 30 cm, 12 x 12 in verde alpi, smooth,
Mosaic sheet 30 x 30 cm, 12 x 12 in verde alpi, smooth, R10/B



Mosaic sheet 30 x 30 cm, 12 x 12 in illusion dark, smooth,
Mosaic sheet 30 x 30 cm, 12 x 12 in illusion dark, smooth, R10/B

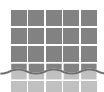

Mosaics glued thermoplastically on back of AGROB BUCHTAL can be used not only in dry zones but also without any problems in underwater areas (e.g. swimming pools/whirlpools) as well as in permanently wet areas (e.g. pool surrounds/showers).

Mosaic

1 x 1 cm

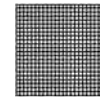

Mosaic. glued
thermoplastically
on back
Sheet: 313 x 313 mm

2.5 x 2.5 cm

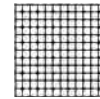

Mosaic. glued
thermoplastically
on back
Sheet: 297 x 297 mm



					1 x 1 / 3/8 x 3/8	2.5 x 2.5 / 1 x 1	
					12 x 12 x 6.5 mm	23 x 23 x 6.5 mm	Nennmaß
					smooth, glossy	smooth, glossy	Work size
					10.000	11.000	Surface
					11.930	12.100	m ² - pieces
					10	11	m ² - kg
					1.000	1.000	Bundle - pieces
					11.930	12.100	Bundle - m ²
					24.000	48.000	Bundle - kg
					286.320	580.800	Pallet - m ²
					B1b	B1b	Pallet - kg
							Product standard
							Slip resistance
					1 - 2	1 - 2	Stress group
					431123H	431117H	3
					Price gr. A379 (m ²)	Price gr. A229 (m ²)	carrara white
					431124H	431118H	3
					Price gr. A379 (m ²)	Price gr. A229 (m ²)	illusion beige
					431125H	431119H	3
					Price gr. A379 (m ²)	Price gr. A229 (m ²)	cielo
					431126H	431120H	2
					Price gr. A379 (m ²)	Price gr. A229 (m ²)	labradorit blue
					431127H	431121H	2
					Price gr. A379 (m ²)	Price gr. A229 (m ²)	verde alpi
					431128H	431122H	2
					Price gr. A379 (m ²)	Price gr. A229 (m ²)	illusion dark

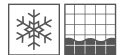

Mosaic

2.5 x 2.5 cm

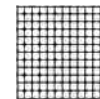

Mosaic. glued
thermoplastically
on back
Sheet: 297 x 297 mm



					2.5 x 2.5 / 1 x 1		
					23 x 23 x 6.5 mm		Nennmaß
					smooth, matt		Work size
					11.000		Surface
					12.100		m ² - pieces
					11		m ² - kg
					1.000		Bundle - pieces
					12.100		Bundle - m ²
					48.000		Bundle - kg
					580.800		Pallet - m ²
					B1b		Pallet - kg
					R10/B		Product standard
					1 - 2		Slip resistance
							Stress group
					431111H	4	
					Price gr. A238 (m ²)		carrara white
					431112H	4	
					Price gr. A238 (m ²)		illusion beige
					431113H	4	
					Price gr. A238 (m ²)		cielo
					431114H	3	
					Price gr. A238 (m ²)		labradorit blue
					431115H	2	
					Price gr. A238 (m ²)		verde alpi
					431116H	4	
					Price gr. A238 (m ²)		illusion dark

All products: Color Shade Variation V4

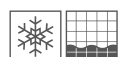

220 NATURAL CERAMICS

Project: Main station / Location: Lübeck, Germany / Architect: GÖSSLER KINZ KREIENBAUM Architekten BDA / Series: Natural Ceramics / Photo: Daniel Sumesgutner

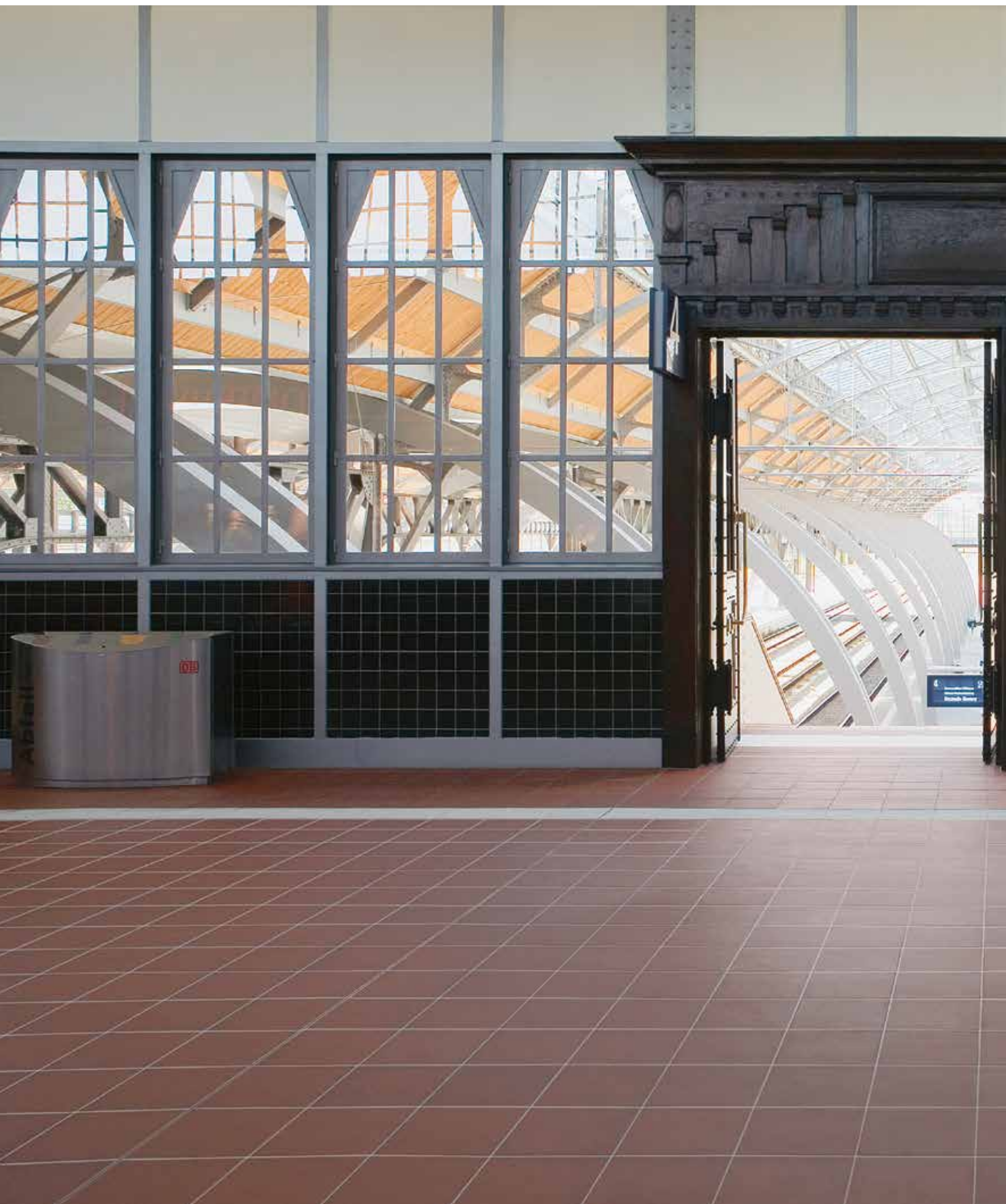



Every tile is unique

Natural Ceramics combines creative diversity and traditional craftsmanship in an authentic ceramic product. And as the material is absolutely frost-proof, a uniform, harmonious floor design of indoor and outdoor areas can be realized. The unique play of colors in warm earthy shades offers a great deal of comfort with maximum design freedom. Special pieces for stairs and parapets support the perfect execution of sophisticated room concepts.



R11/A R11/B



golden ochre



golden cream



golden grey



golden black



autumn leaves



natural-red



portofino



colorado-brown



brick-red



tobacco



Floor/wall tile 15 x 15 cm, 6 x 6 in
hammered, R11/A



Floor/wall tile 12.5 x 25 cm, 5 x 10 in, smooth
Floor/wall tile 12.5 x 25 cm, 5 x 10 in, smooth, R11/A
Floor/wall tile 12.5 x 25 cm, 5 x 10 in, smooth, R11/B
Floor/wall tile 12.5 x 25 cm, 5 x 10 in, hammered, R11/A



Floor/wall tile 15 x 30 cm, 6 x 12 in, hammered, R11/A



Floor/wall tile 25 x 25 cm, 10 x 10 in, smooth
Floor/wall tile 25 x 25 cm, 10 x 10 in, smooth, R11/A
Floor/wall tile 25 x 25 cm, 10 x 10 in, smooth, R11/B
Floor/wall tile 25 x 25 cm, 10 x 10 in, hammered, R11/A

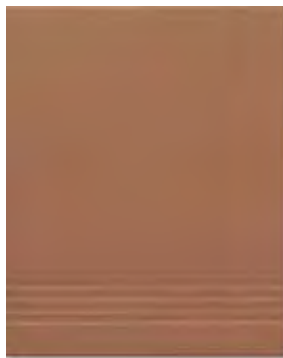

Stair tile 25 x 30 cm, 10 x 12 in, (with grooves), smooth, R11/A
Stair tile 25 x 30 cm, 10 x 12 in, (with grooves), smooth, R11/B
Stair tile 25 x 30 cm, 10 x 12 in, corner right, (with grooves), smooth, R11/A
Stair tile 25 x 30 cm, 10 x 12 in, corner right, (with grooves), smooth, R11/B
Stair tile 25 x 30 cm, 10 x 12 in, corner left, (with grooves), smooth, R11/A
Stair tile 25 x 30 cm, 10 x 12 in, corner left, (with grooves), smooth, R11/B



Skirting, rounded 8.3 x 30 cm, 3 5/16 x 12 in, hammered



Skirting, rounded 8.3 x 25 cm, 3 5/16 x 10 in, smooth
Skirting, rounded 8.3 x 25 cm, 3 5/16 x 10 in, hammered



Nosing tile 12.5 x 30 cm, 5 x 12 in, hammered, R11/A



Nosing tile, 12.5 x 25 cm, 5 x 10 in, smooth
Nosing tile, 12.5 x 25 cm, 5 x 10 in, smooth, R11/A
Nosing tile, 12.5 x 25 cm, 5 x 10 in, smooth, R11/B
Nosing tile, 12.5 x 25 cm, 5 x 10 in, hammered, R11/A



Florentiner stair tile 25 x 35 cm, 10 x 14 in, smooth, R11/A
Florentiner stair tile 25 x 35 cm, 10 x 14 in, smooth, R11/B
Florentiner stair tile 25 x 35 cm, 10 x 14 in, hammered, R11/A



Florentiner corner piece 35 x 35 cm, 14 x 14 in, smooth, R11/A
Florentiner corner piece 35 x 35 cm, 14 x 14 in, smooth, R11/B
Florentiner corner piece 35 x 35 cm, 14 x 14 in, hammered, R11/A



Florentiner skirting right or left, smooth



Florentiner Piccolo 12,5 x 25 cm, 5 x 10 in, hammered, R11/A



Corner piece, glued 7.3 x 24 cm, 11.5 x 11 cm, hammered

Floor/Wall Tiles¹

12.5 x 25 cm



25 x 25 cm



15 x 15 cm



15 x 30 cm



12.5 x 25 cm



25 x 25 cm



Model number	1010	1630	1030	1020	1100	1620	
Nom. dim. - cm/in	12.5 x 25 / 5 x 10	25 x 25 / 10 x 10	15 x 15 / 6 x 6	15 x 30 / 6 x 12	12.5 x 25 / 5 x 10	25 x 25 / 10 x 10	
Work size	115 x 240 x 10 mm	240 x 240 x 10 mm	140 x 140 x 11 mm	140 x 290 x 11 mm	115 x 240 x 11 mm	240 x 240 x 11 mm	
Surface	smooth, matt ²	smooth, matt ²	hammered, matt	hammered, matt	smooth, silky glossy	smooth, silky glossy	
m ² - pieces	33.000	16.000	44.440	22.220	33.000	16.000	
m ² - kg	19.800	20.160	19.642	21.442	21.450	23.680	
Bundle - pieces	26	13	24	18	24	12	
Bundle - m ²	0.788	0.813	0.540	0.810	0.727	0.750	
Bundle - kg	15.600	16.380	10.608	17.370	15.600	17.760	
Pallet - m ²	56.727	51.188	45.905	37.264	52.364	47.250	
Pallet - kg	1,123.200	1,031.940	901.680	799.020	1,123.200	1,118.880	
Product standard	Alla	Alla	Alla	Alla	Alla	Alla	
Slip resistance	see below	see below	R11/A	R11/A			
Stress group	2	2	2	2			
	R11/A	R11/A					
golden ochre	851-1010 Price gr. A88 (m ²)	851-1630 Price gr. A115 (m ²)	851-1030 Price gr. A88 (m ²)	851-1020 Price gr. A115 (m ²)			
	R11/A	R11/A					
golden cream	854-1010 Price gr. A88 (m ²)	854-1630 Price gr. A115 (m ²)	854-1030 Price gr. A88 (m ²)	854-1020 Price gr. A115 (m ²)			
	R11/A	R11/A					
golden grey	855-1010 Price gr. A88 (m ²)	855-1630 Price gr. A115 (m ²)	855-1030 Price gr. A88 (m ²)	855-1020 Price gr. A115 (m ²)			
	R11/A	R11/A					
golden black	856-1010 Price gr. A88 (m ²)	856-1630 Price gr. A115 (m ²)	856-1030 Price gr. A88 (m ²)	856-1020 Price gr. A115 (m ²)			
	R11/B	R11/B					
autumn leaves	0105-1010 Price gr. A88 (m ²)	0105-1630 Price gr. A115 (m ²)					
	R11/B	R11/B					
natural-red	0705-1010 Price gr. A88 (m ²)	0705-1630 Price gr. A115 (m ²)					
	R11/A	R11/A					
portofino	948-1010 Price gr. A88 (m ²)	948-1630 Price gr. A115 (m ²)					
	R11/B	R11/B					
colorado-brown	950-1010 Price gr. A88 (m ²)	950-1630 Price gr. A115 (m ²)					
	R11/A	R11/A					
brick-red	958-1010 Price gr. A88 (m ²)	958-1630 Price gr. A115 (m ²)					
	3						
tobacco					951-1100³ Price gr. A88 (m ²)	951-1620³ Price gr. A115 (m ²)	



¹ Color Shade Variation

V1: natural-red, brick-red

V2: golden cream, golden grey, golden black

V3: autumn leaves

V4: golden ochre, portofino, colorado-brown, tobacco

² Exception: golden ochre, golden cream, golden grey, golden black: hammered, matt

³ Exception: color 951 tobacco complies with DIN EN 14411 Alla - part 1, glazed (GL)

Note: Surface to be treated with a suitable impregnation agent, refer to page 707.

Skirtings, rounded¹

Nosing Tiles¹

Stair System¹

8.3 x 25 cm

8.3 x 30 cm

12.5 x 25 cm

12.5 x 30 cm

25 x 30 cm

25 x 30 cm

25 x 30 cm

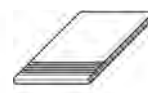
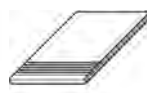
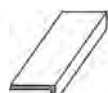

9066	9063	4822	4825	Stair Tile	Corner left	Corner right	
8.3 x 25 / 33/8 x 10	8.3 x 30 / 33/8 x 12	12.5 x 25 / 5 x 10	12.5 x 30 / 5 x 12	25 x 30 / 10 x 12	25 x 30 / 10 x 12	25 x 30 / 10 x 12	Model number
73 x 240 x 11 mm	73 x 290 x 11 mm	115/52 x 240 x 11 mm	115/52 x 290 x 11 mm	240 x 300 x 14 mm	240 x 300 x 14 mm	240 x 300 x 14 mm	Nom. dim. - cm/in
smooth, matt ²	hammered, matt	smooth, matt ²	hammered, matt	smooth, matt ²	smooth, matt ²	smooth, matt ²	Work size
4.000	3.333	4.000	3.333	4.000			Surface
1.600/m	1.600/m	3.880/m	3.903/m	8.600/m	2.100/pieces	2.100/pieces	m - pieces
22	22	8	8	8	8	8	m/pce. - kg
5.500	6.601	2.000	2.400	2.000			Bundle - pieces
8.800	10.560	7.760	9.368	17.200	16.800	16.800	Bundle - m
							Bundle - kg
Alla	Alla	Alla	Alla	Alla	Alla	Alla	Pallet - m
		see below	R11/A	see below	see below	see below	Pallet - kg
851-9066	851-9063	851-4822	851-4825				Product standard
Price gr. A410 (pce.)	Price gr. A416 (pce.)	Price gr. A426 (pce.)	Price gr. A449 (pce.)				Slip resistance
		R11/A					golden ochre
854-9066	854-9063	854-4822	854-4825				golden cream
Price gr. A410 (pce.)	Price gr. A416 (pce.)	Price gr. A426 (pce.)	Price gr. A449 (pce.)				golden grey
		R11/A					golden black
855-9066	855-9063	855-4822	855-4825				autumn leaves
Price gr. A410 (pce.)	Price gr. A416 (pce.)	Price gr. A426 (pce.)	Price gr. A449 (pce.)				natural-red
		R11/A		R11/B	R11/B	R11/B	portofino
856-9066	856-9063	856-4822	856-4825	0105-9066	0105-9570	0105-9573	colorado-brown
Price gr. A410 (pce.)	Price gr. A416 (pce.)	Price gr. A426 (pce.)	Price gr. A449 (pce.)	Price gr. A410 (pce.)	Price gr. A458 (pce.)	Price gr. A487 (pce.)	brick-red
		R11/B					tobacco
0105-9066		0105-4822		0705-9066	0705-9570	0705-9573	
Price gr. A410 (pce.)		Price gr. A426 (pce.)		Price gr. A410 (pce.)	Price gr. A458 (pce.)	Price gr. A487 (pce.)	
		R11/B					
0705-9066		0705-4822		948-9066	948-9570	948-9573	
Price gr. A410 (pce.)		Price gr. A426 (pce.)		Price gr. A410 (pce.)	Price gr. A458 (pce.)	Price gr. A487 (pce.)	
		R11/A					
948-9066		948-4822		950-9066			
Price gr. A410 (pce.)		Price gr. A426 (pce.)		Price gr. A410 (pce.)			
		R11/B					
950-9066		950-4822		958-9066			
Price gr. A410 (pce.)		Price gr. A426 (pce.)		Price gr. A410 (pce.)			
		R11/A					
958-9066		958-4822		951-9066³			
Price gr. A410 (pce.)		Price gr. A426 (pce.)		Price gr. A410 (pce.)			
		R11/A					
951-9066³		951-4822³					
Price gr. A410 (pce.)		Price gr. A426 (pce.)					

¹ Color Shade Variation

V1: natural-red, brick-red

V2: golden cream, golden grey, golden black

V3: autumn leaves

V4: golden ochre, portofino, colorado-brown, tobacco

² Exception: golden ochre, golden cream, golden grey, golden black: hammered, matt, tobacco: smooth, silky glossy

³ Exception: color 951 tobacco complies with DIN EN 14411 Alla - part 1, glazed (GL)



For technical reasons slight differences in color/size compared to standard tiles can not be excluded.

Note: Surface to be treated with a suitable impregnation agent, refer to page 707.

Florentiner Stair System³

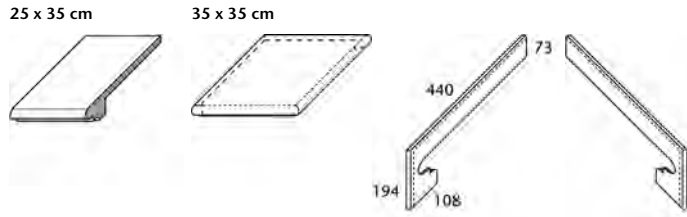

Florentiner Piccolo³



Corner Piece³

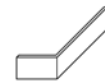

	Stair tile	Corner piece (suitable for left and right)	Skirting left ¹	Skirting right ¹		Corner piece glued
Model number	9330	9335	9337	9338	9822	2541
Nom. dim. - cm/in	25 x 35 / 10 x 14	35 x 35 / 14 x 14			12.5 x 25 / 5 x 10	
Work size mm	240 x 350 x 42/14	350 x 350 x 42/14	440/73 x 194/108 x 11	440/73 x 194/108 x 11	115/52 x 240 x 11	73 x 240/115 x 11
Surface	smooth, matt ²	smooth, matt ²	smooth, matt ²	smooth, matt ²	hammered, matt	hammered, matt
m - pieces	4.000				4.000	
m/pce. - kg	11.600/m	4.900/pieces	0.900/pieces	0.900/pieces	3.900/m	0.600/pieces
Bundle - pieces	6	1	4	4	8	18
Bundle - m	1.500				2.000	
Bundle - kg	17.400	4.900	3.600	3.600	7.800	10.800
Pallet - m						
Pallet - kg						
Product standard	Alla	Alla	Alla	Alla	Alla	
Slip resistance	see below	see below			R11/A	
	R11/A	R11/A				
	851-9330	851-9335	851-9337	851-9338	851-9822	851-2541
golden ochre	Price gr. A467 (pce.)	Price gr. A601 (pce.)	Price gr. A484 (pce.)	Price gr. A484 (pce.)	Price gr. A441 (pce.)	Price gr. A441 (pce.)
	R11/A	R11/A				
	854-9330²	854-9335	854-9337	854-9338	854-9822	854-2541
golden cream	Price gr. A467 (pce.)	Price gr. A601 (pce.)	Price gr. A484 (pce.)	Price gr. A484 (pce.)	Price gr. A441 (pce.)	Price gr. A441 (pce.)
	R11/A	R11/A				
	855-9330	855-9335	855-9337	855-9338	855-9822	855-2541
golden grey	Price gr. A467 (pce.)	Price gr. A601 (pce.)	Price gr. A484 (pce.)	Price gr. A484 (pce.)	Price gr. A441 (pce.)	Price gr. A441 (pce.)
	R11/A	R11/A				
	856-9330	856-9335	856-9337	856-9338	856-9822	856-2541
golden black	Price gr. A467 (pce.)	Price gr. A601 (pce.)	Price gr. A484 (pce.)	Price gr. A484 (pce.)	Price gr. A441 (pce.)	Price gr. A441 (pce.)
	R11/B	R11/B				
	010S-9330	010S-9335	010S-9337	010S-9338		
autumn leaves	Price gr. A467 (pce.)	Price gr. A601 (pce.)	Price gr. A484 (pce.)	Price gr. A484 (pce.)		
	R11/B	R11/B				
	070S-9330	070S-9335	070S-9337	070S-9338		
natural-red	Price gr. A467 (pce.)	Price gr. A601 (pce.)	Price gr. A484 (pce.)	Price gr. A484 (pce.)		
	R11/A	R11/A				
	948-9330	948-9335	948-9337	948-9338		
portofino	Price gr. A467 (pce.)	Price gr. A601 (pce.)	Price gr. A484 (pce.)	Price gr. A484 (pce.)		
	R11/A	R11/A				
	958-9330	958-9335	958-9337	958-9338		
brick-red	Price gr. A467 (pce.)	Price gr. A601 (pce.)	Price gr. A484 (pce.)	Price gr. A484 (pce.)		



¹ Prolongation of the skirtings 9337/9338 with model no. 9066 (240 x 73 x 11 mm) or model no. 9063 (290 x 73 x 11 mm).

² Exception: golden ochre, golden cream, golden grey, golden black: hammered, matt

³ Color Shade Variation

V1: natural-red, brick-red

V2: golden cream, golden grey, golden black

V3: autumn leaves

V4: golden ochre, portofino

For technical reasons slight differences in color/size compared to standard tiles can not be excluded.

Note: Surface to be treated with a suitable impregnation agent, refer to page 707.

Studio photo / Series: Natural Ceramics



Project: EDEKA supermarket / Location: Flensburg, Germany / Series: New Market / Photo: Jochen Stüber, Hamburg





Endurance test: withstanding any pressure

Floors in supermarkets should be attractive, easy to clean and extremely robust. Agrob Buchtal meets these requirements with extra thick tiles in thicknesses of up to 14 mm. With breaking strength values which are considerably higher than required by the relevant standards, the rectified large formats also withstand the loads caused by driving forklift trucks and pallet trucks without any problems. At the same time, extreme robustness is combined with an attractive look: porcelain stoneware surfaces in a wide range of colors offer all the prerequisites for a representative design. And the proven Protecta surface upgrading guarantees effective stain protection.

Design Area Pro



pebble



sand-white



sand-grey

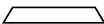

Floor tile 60 x 60 cm, 24 x 24 in, extra thick, smooth, R10

 The formats 30 x 60 cm, 12 x 24 in, and 60 x 60 cm, 24 x 24 in, are conically rectified.



Design Basis Pro



anthracite



concrete-grey

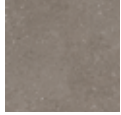

ash-brown



sand-beige



Floor tile 30 x 30 cm, 12 x 12 in, extra thick, smooth, R10



Floor tile 30 x 60 cm, 12 x 24 in, extra thick, smooth, R10

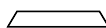

Floor tile 60 x 60 cm, 24 x 24 in, extra thick, smooth, R10

 The formats 30 x 60 cm, 12 x 24 in, and 60 x 60 cm, 24 x 24 in, are conically rectified.



Design Like



cement

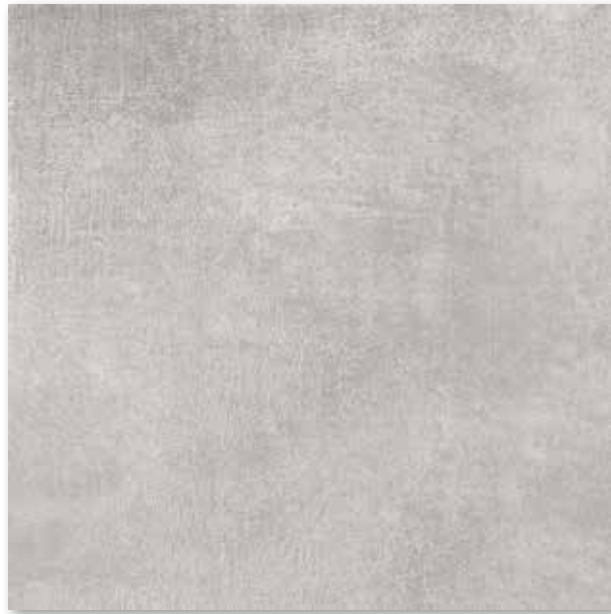

Floor tile 60 x 60 cm, 24 x 24 in, extra thick, structured, R10

Design Portland



anthracite



Floor tile 30 x 30 cm, 12 x 12 in, extra thick, smooth, R10

Design Walden



classic oak



relax beige

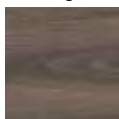

smokey brown

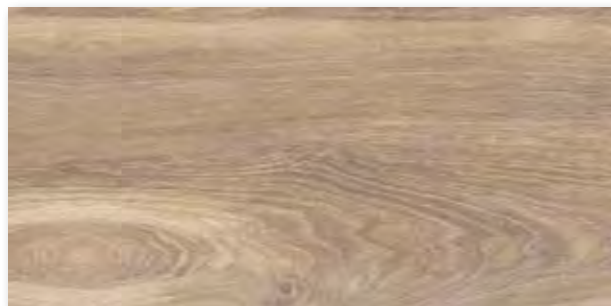

Floor tile 30 x 60 cm, 12 x 24 in, extra thick, structured, R10

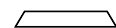
 The formats 30 x 60 cm, 12 x 24 in, and 60 x 60 cm, 24 x 24 in, are conically rectified.

Floor Tiles² **NEW**

30 x 30 cm⁴



30 x 30 cm³



30 x 60 cm^{1/3}



30 x 60 cm^{1/2}



60 x 60 cm^{1/3}



60 x 60 cm^{1/5/6}



60 x 60 cm^{1/3}



protected

<i>Design Portland</i>	<i>Design Basis Pro</i>	<i>Design Basis Pro</i>	<i>Design Walden</i>	<i>Design Basis Pro</i>	<i>Design Area Pro</i>	<i>Design Like</i>	
30 x 30 / 12 x 12	30 x 30 / 12 x 12	30 x 60 / 12 x 24	30 x 60 / 12 x 24	60 x 60 / 24 x 24	60 x 60 / 24 x 24	60 x 60 / 24 x 24	Nom. dim. - cm/in
297 x 297 x 14 mm	297 x 297 x 14 mm	297 x 597 x 14 mm	297 x 597 x 14 mm	600 x 600 x 14 mm	600 x 600 x 14 mm	600 x 600 x 14 mm	Work size
smooth, matt	smooth, matt	smooth, matt	structured, matt	smooth, matt	smooth, matt	structured, matt	Surface
11.337	11.337	5.589	5.589	2.778	2.778	2.778	m ² - pieces
32.027	32.027	32.159	32.159	31.669	31.669	31.669	m ² - kg
7	7	4	4	2	2	2	Bundle - pieces
0.617	0.617	0.716	0.716	0.720	0.720	0.720	Bundle - m ²
19.775	19.775	23.016	23.016	22.800	22.800	22.800	Bundle - kg
29.637	29.637	28.628	28.628	30.238	30.238	30.238	Pallet - m ²
949.200	949.200	920.640	920.640	957.600	957.600	957.600	Pallet - kg
Bla	Bla	Bla	Bla	Bla	Bla	Bla	Product standard
R10	R10	R10	R10	R10	R10	R10	Slip resistance
3 - 4	3 - 4	3 - 4	3 - 4	3 - 4	3 - 4	3 - 4	Stress group
434194							Portland
	430992	430994		430976			anthracite
	430993	430995		430977			Basis Pro anthracite
		430996		430978			Basis Pro concrete-grey
		430997		430979			Basis Pro ash-brown
			432292				Basis Pro sand-beige
			432293				Walden classic oak
			432294				Walden relax beige
							Walden smokey brown
					430200H		Area Pro pebble
					430201H		Area Pro sand-white
					430202H		Area Pro sand-grey
						430684	Like cement

¹ conically rectified

² Make-to-order production: return and/or cancellation of ordered products not possible.

³ Color Shade Variation: V2

⁴ Color Shade Variation: V3

⁵ with Hytect coating



Note: The prices are calculated project-specifically.



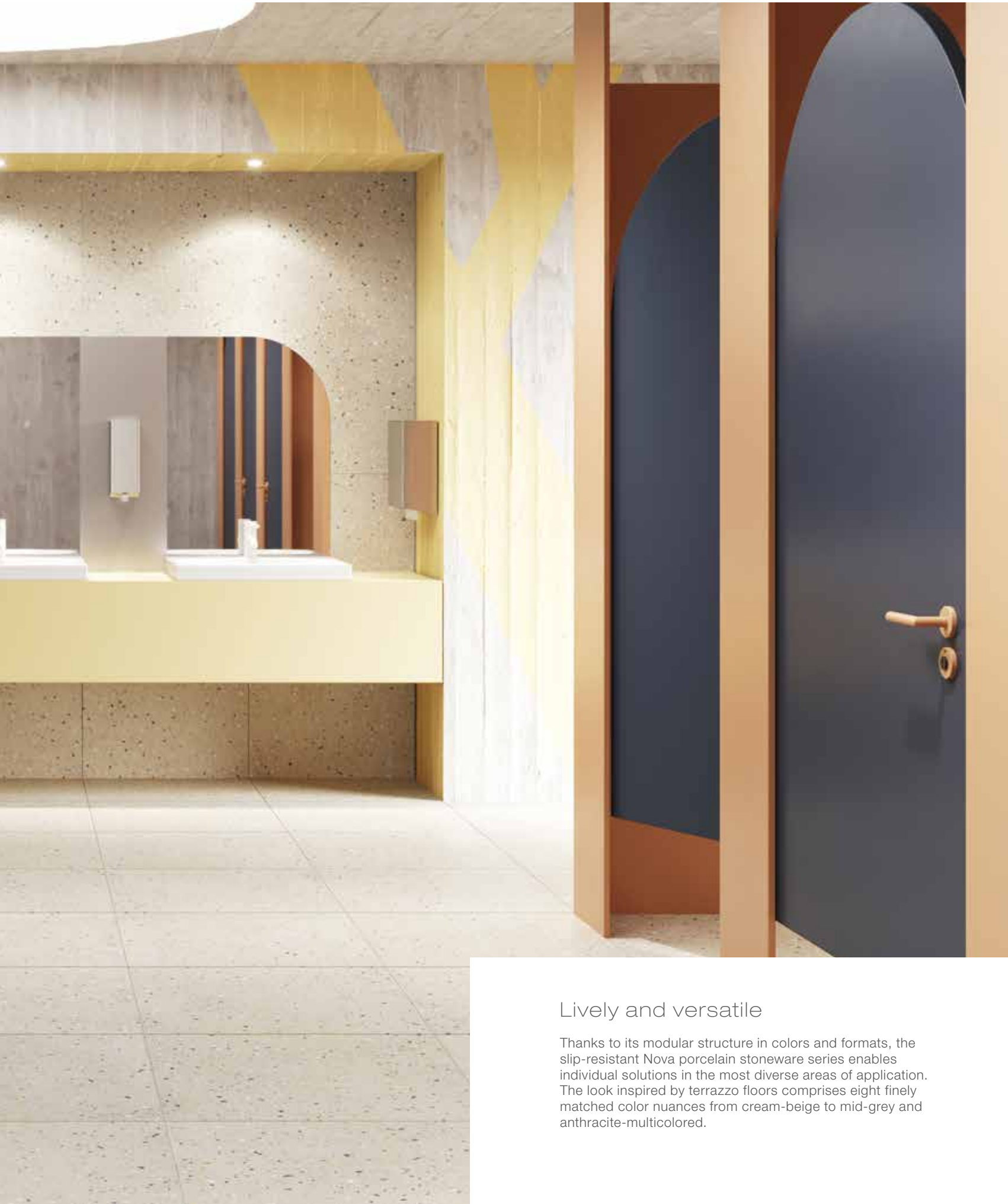

Lively and versatile

Thanks to its modular structure in colors and formats, the slip-resistant Nova porcelain stoneware series enables individual solutions in the most diverse areas of application. The look inspired by terrazzo floors comprises eight finely matched color nuances from cream-beige to mid-grey and anthracite-multicolored.



cream-beige

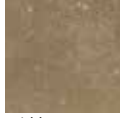

mid-brown



mid-grey

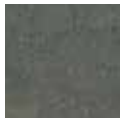

basalt



anthracite



cream-beige-multicolored



mid-grey-multicolored



anthracite-multicolored



Floor tile 15 x 15 cm, smooth, R10/B
Floor tile 15 x 15 cm, smooth, R11/C

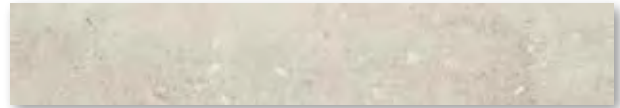

Oblong format 10 x 60 cm, smooth, R10/A



Oblong format 15 x 60 cm, smooth, R10/A



Floor tile 30 x 60 cm, smooth, R10/A
Floor tile 30 x 60 cm, smooth, R11/B



Floor tile 60 x 60 cm, smooth, R10/A



Washbasin SURF® large 55 x 120 cm, 22 x 48 in (available on request).
Further information about Surf on pages 305 and the following.



Floor tile 60 x 120 cm, 24 x 48 in, smooth, R10/A



Floor tile 120 x 120 cm, 48 x 48 in, smooth, R10/A



R10/A R10/B



Mosaic 5 x 5 cm, 2 x 2 in



cream-beige

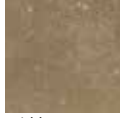

mid-brown



mid-grey



basalt



anthracite

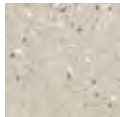

cream-beige-multicolored



mid-grey-multicolored



anthracite-multicolored



Stair tile 30 x 60 cm, 12 x 24 in (with grooves), smooth, R10/A



Mosaic sheet 30 x 30 cm, 12 x 12 in, smooth, R10/B

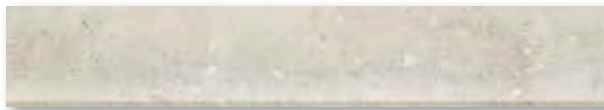

Cove skirting 10 x 60 cm, 4 x 24 in, smooth

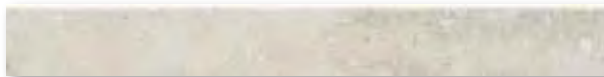

Skirting rounded 7 x 60 cm, 2 13/16 x 24 in, smooth



Stair tile with bevel 31 x 135 cm, 12 13/64 x 53 5/32 in, smooth, R10/A



Riser 28 x 135 cm, 11.2 x 54 in, smooth

Mosaic¹

Floor Tiles

5 x 5 cm

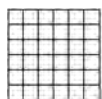

15 x 15 cm



15 x 15 cm



10 x 60 cm^{1/2}



15 x 60 cm^{1/2}



Mosaic, glass fibre net
on reverse side
Sheet: 297 x 297 mm

Oblong format

Oblong format



	5 x 5 / 2 x 2	15 x 15 / 6 x 6	15 x 15 / 6 x 6	10 x 60 / 4 x 24	15 x 60 / 6 x 24	Nom. dim. - cm/in
	47 x 47 x 10.5 mm	147 x 147 x 8 mm	147 x 147 x 8 mm	97 x 597 x 10.5 mm	147 x 597 x 10.5 mm	Work size
	smooth, matt	smooth, matt	smooth, matt	smooth, matt	smooth, matt	Surface
	11.111 sheets	44.444	44.444	16.667	11.111	m ² - pieces
	21.966	17.555	17.555	21.967	21.966	m ² - kg
	11 sheets	35	35	15	11	Bundle - pieces
	0.990	0.788	0.788	0.900	0.990	Bundle - m ²
	21.747	13.825	13.825	19.770	21.747	Bundle - kg
	29.700	63.001	63.001	35.993	39.600	Pallet - m ²
	652.410	1.106.000	1.106.000	790.800	869.880	Pallet - kg
	Alb	Bla	Bla	Alb	Alb	Product standard
	R10/B	R10/B	R11/C	R10/A	R10/A	Slip resistance
	2 - 3	2	2	2 - 3	2 - 3	Stress group
	431801H	431807H	431873H	431817H	431823H	cream-beige
	Price gr. A286 (m ²)	Price gr. A157 (m ²)	Price gr. A157 (m ²)	Price gr. A217 (m ²)	Price gr. A217 (m ²)	
	431802H	431808H	431874H	431818H	431824H	mid-brown
	Price gr. A286 (m ²)	Price gr. A157 (m ²)	Price gr. A157 (m ²)	Price gr. A217 (m ²)	Price gr. A217 (m ²)	
	431803H	431809H	431875H	431819H	431825H	mid-grey
	Price gr. A286 (m ²)	Price gr. A157 (m ²)	Price gr. A157 (m ²)	Price gr. A217 (m ²)	Price gr. A217 (m ²)	
	431804H	431810H	431876H	431820H	431826H	basalt
	Price gr. A286 (m ²)	Price gr. A157 (m ²)	Price gr. A157 (m ²)	Price gr. A217 (m ²)	Price gr. A217 (m ²)	
	431805H	431811H	431877H	431821H	431827H	anthracite
	Price gr. A286 (m ²)	Price gr. A157 (m ²)	Price gr. A157 (m ²)	Price gr. A217 (m ²)	Price gr. A217 (m ²)	
	431744H			431746H	431748H	cream-beige NEW
	Price gr. A286 (m ²)			Price gr. A217 (m ²)	Price gr. A217 (m ²)	multicolored
	431745H			431747H	431749H	mid-grey NEW
	Price gr. A286 (m ²)			Price gr. A217 (m ²)	Price gr. A217 (m ²)	multicolored
	431806H			431822H	431828H	anthracite
	Price gr. A286 (m ²)			Price gr. A217 (m ²)	Price gr. A217 (m ²)	multicolored

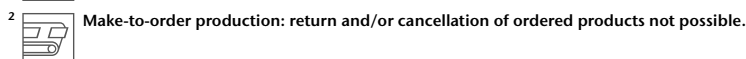

All products: Color Shade Variation V3; colors cream-beige-multicolored, mid-grey-multicolored, anthracite-multicolored: V4

Floor Tiles¹

30 x 60 cm

30 x 60 cm

60 x 60 cm²



Nom. dim. - cm/in	30 x 60 / 12 x 24	30 x 60 / 12 x 24	60 x 60 / 24 x 24				
Work size	297 x 597 x 10.5 mm	297 x 597 x 10.5 mm	597 x 597 x 10.5 mm				
Surface	smooth, matt	smooth, matt	smooth, matt				
m ² - pieces	5.556	5.556	2.778				
m ² - kg	21.974	21.974	21.996				
Bundle - pieces	6	6	3				
Bundle - m ²	1.080	1.080	1.080				
Bundle - kg	23.730	23.730	23.754				
Pallet - m ²	43.197	43.197	32.397				
Pallet - kg	949.200	949.200	712.620				
Product standard	Alb	Alb	Alb				
Slip resistance	R10/A	R11/B	R10/A				
Stress group	2 - 3	2 - 3	2 - 3				
cream-beige	431829H Price gr. A148 (m ²)	431835H Price gr. A154 (m ²)	431840H Price gr. A157 (m ²)				
mid-brown	431830H Price gr. A148 (m ²)	431836H Price gr. A154 (m ²)	431841H Price gr. A157 (m ²)				
mid-grey	431831H Price gr. A148 (m ²)	431837H Price gr. A154 (m ²)	431842H Price gr. A157 (m ²)				
basalt	431832H Price gr. A148 (m ²)	431838H Price gr. A154 (m ²)	431843H Price gr. A157 (m ²)				
anthracite	431833H Price gr. A148 (m ²)	431839H Price gr. A154 (m ²)	431844H Price gr. A157 (m ²)				
cream-beige NEW	431750H Price gr. A148 (m ²)		431752H Price gr. A157 (m ²)				
multicolored	431751H Price gr. A148 (m ²)		431753H Price gr. A157 (m ²)				
mid-grey NEW	431834H Price gr. A148 (m ²)		431845H Price gr. A157 (m ²)				
anthracite							
multicolored							



² High weight only to carry with two persons.

All products: Color Shade Variation V3; colors cream-beige-multicolored, mid-grey-multicolored, anthracite-multicolored: V4

Floor Tiles¹

Stair Tile^{2/3} Stair Tile with Bevel^{2/3} Riser^{2/3}

60 x 120 cm

120 x 120 cm^{4/5}

30 x 60 cm

31 x 135 cm

28 x 135 cm

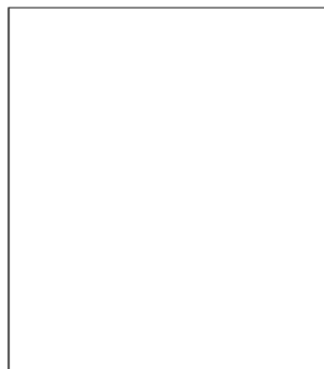

	60 x 120 / 24 x 48	120 x 120 / 48 x 48		30 x 60 / 12 x 24	31 x 135 / 12 1364 x 53 532	28 x 135 / 11 x 53 5/32	Nom. dim. - cm/in
	597 x 1197 x 10.5 mm	1197 x 1197 x 6 mm		297 x 597 x 10.5 mm	307 x 1347 x 10.5 mm	280 x 1347 x 10.5 mm	Work size
	smooth. matt	smooth. matt		smooth. matt	smooth. matt	smooth. matt	Surface
	1.388/m ²	0.694/m ²		1.667/m	0.741/m	0.741/m	m ² /m - pieces
	21.980/m ²	13.991/m ²		6.593/m	7.321/m	6.676/m	m ² /m - kg
	2	2		6	2	2	Bundle - pieces
	1.441 m ²	2.881 m ²		3.599 m	2.699 m	2.699 m	Bundle - m ² /m
	31.672	40.320		23.730	19.760	18.020	Bundle - kg
	30.259	72.005					Pallet - m ²
	665.112	1,008.000					Pallet - kg
	Alb	Bla		Alb	Alb	Alb	Product standard
	R10/A	R10/A		R10/A	R10/A		Slip resistance
	2 - 3	1 - 2		2 - 3	2 - 3	2 - 3	Stress group
	431846H	431878		431852H	431858H	431788H	cream-beige
	Price gr. A169 (m ²)	Price gr. A178 (m ²)		Price gr. A475 (pce.)	Price gr. A560 (pce.)	Price gr. A528 (pce.)	
	431847H	431879		431853H	431859H	431789H	mid-brown
	Price gr. A169 (m ²)	Price gr. A178 (m ²)		Price gr. A475 (pce.)	Price gr. A560 (pce.)	Price gr. A528 (pce.)	
	431848H	431880		431854H	431860H	431790H	mid-grey
	Price gr. A169 (m ²)	Price gr. A178 (m ²)		Price gr. A475 (pce.)	Price gr. A560 (pce.)	Price gr. A528 (pce.)	
	431849H	431881		431855H	431861H	431791H	basalt
	Price gr. A169 (m ²)	Price gr. A178 (m ²)		Price gr. A475 (pce.)	Price gr. A560 (pce.)	Price gr. A528 (pce.)	
	431850H	431882		431856H	431862H	431792H	anthracite
	Price gr. A169 (m ²)	Price gr. A178 (m ²)		Price gr. A475 (pce.)	Price gr. A560 (pce.)	Price gr. A528 (pce.)	
	431754H			431756H	431758H	431760H	cream-beige NEW
	Price gr. A169 (m ²)			Price gr. A475 (pce.)	Price gr. A560 (pce.)	Price gr. A528 (pce.)	multicolored
	431755H			431757H	431759H	431761H	mid-grey NEW
	Price gr. A169 (m ²)			Price gr. A475 (pce.)	Price gr. A560 (pce.)	Price gr. A528 (pce.)	multicolored
	431851H			431857H	431863H	431793H	anthracite
	Price gr. A169 (m ²)			Price gr. A475 (pce.)	Price gr. A560 (pce.)	Price gr. A528 (pce.)	multicolored

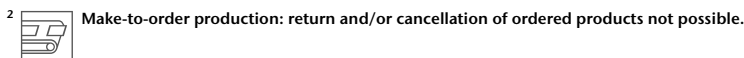

³ Only rectified on the two short sides! The long side can not be rectified!

⁴ Please note: special pallet. packaging lump sum of 40 Euro/pallet. No return. no exchange. / High weight only to carry with two persons.

⁵ Protecta surface upgrading

All products: Color Shade Variation V3; colors cream-beige-multicolored, mid-grey-multicolored, anthracite-multicolored: V4



Skirting,
rounded¹

Cove skirting,
decorated^{1/2/3}

7 x 60 cm

10 x 60 cm



Nom. dim. - cm/in	7 x 60 / 2 13/16 x 24	10 x 60 / 4 x 24				
Work size	70 x 597 x 10.5 mm	100 x 597/35 x 9 mm				
Surface	smooth, matt	smooth, matt				
m - pieces	1.667	1.667				
m - kg	1.554	2.000				
Bundle - pieces	15	20				
Bundle - m	8.998	11.998				
Bundle - kg	13.980	24.000				
Pallet - m						
Pallet - kg						
Product standard	Alb	Alb				
cream-beige	431864H Price gr. A438 (pce.)	431887H Price gr. A445 (pce.)				
mid-brown	431865H Price gr. A438 (pce.)	431893H Price gr. A445 (pce.)				
mid-grey	431866H Price gr. A438 (pce.)	431894H Price gr. A445 (pce.)				
basalt	431867H Price gr. A438 (pce.)	431786H Price gr. A445 (pce.)				
anthracite	431868H Price gr. A438 (pce.)	431787H Price gr. A445 (pce.)				
cream-beige NEW	431762H Price gr. A438 (pce.)					
multicolored	431763H Price gr. A438 (pce.)					
mid-grey NEW	431763H Price gr. A438 (pce.)					
multicolored	431869H Price gr. A438 (pce.)					
anthracite						
multicolored						



¹  rectified

²  Make-to-order production: return and/or cancellation of ordered products not possible.

³ The cove skirting complies with DIN EN 14411, group Al_b, glazed (GL)

All products: Color Shade Variation V3; colors cream-beige-multicolored, mid-grey-multicolored, anthracite-multicolored: V4

3D Rendering / Series: Nova





3D-Rendering / Series: Nova



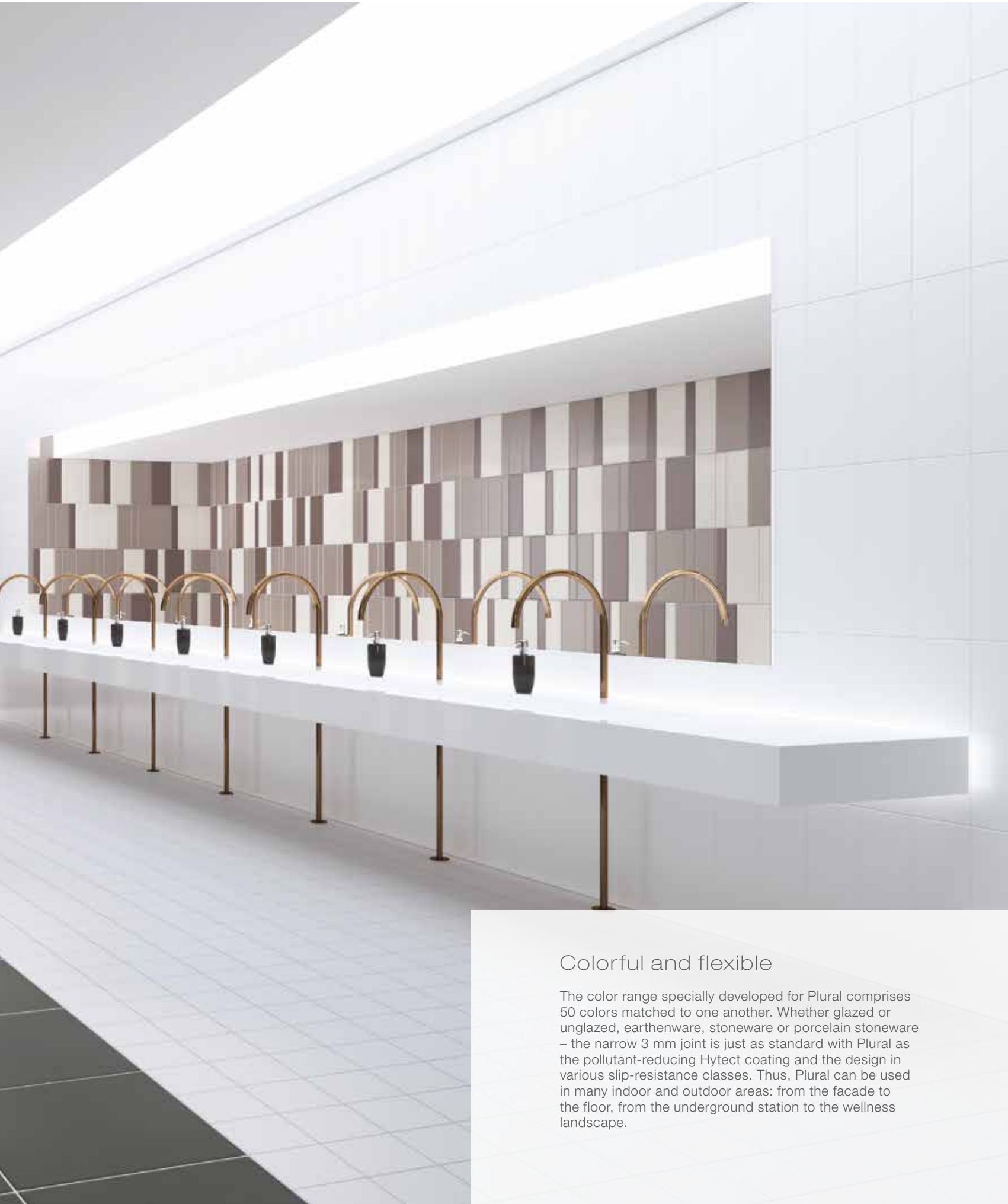

Colorful and flexible

The color range specially developed for Plural comprises 50 colors matched to one another. Whether glazed or unglazed, earthenware, stoneware or porcelain stoneware – the narrow 3 mm joint is just as standard with Plural as the pollutant-reducing Hytect coating and the design in various slip-resistance classes. Thus, Plural can be used in many indoor and outdoor areas: from the facade to the floor, from the underground station to the wellness landscape.

COLOR SYSTEM UNICOLOR – A color sphere becomes a sphere of possibilities



Contrasting colors



active ochre NCS S 3050-Y40R	active salmon NCS S 4040-Y70R	active oxid red NCS S 4050-Y90R	active stone grey NCS S 5030-Y90R	active sand grey NCS S 7010-Y90R
light ochre NCS S 2030-Y20R	light salmon NCS S 1515-Y50R	light oxid red NCS S 2010-Y80R	light stone grey NCS S 2502-R	light sand grey NCS S 1502-Y
medium ochre NCS S 3030-Y30R	medium salmon NCS S 2020-Y50R	medium oxid red NCS S 3020-Y80R	medium stone grey NCS S 3502-R or RAL 7036	medium sand grey NCS S 3005-Y50R
dark ochre NCS S 4030-Y50R	dark salmon NCS S 3040-Y60R	dark oxid red NCS S 5020-Y80R	dark stone grey NCS S 6005-Y80R	dark sand grey NCS S 6010-Y50R
ochre	salmon	oxid red	stone grey	sand grey
neutral 5 (basalt-grey) NCS S 5502-B or RAL 7046	neutral 4 (graphite-black) NCS S 6000-N or RAL 7037	neutral 3 (asphalt black) NCS S 6500-N	neutral 2 (anthracite) NCS S 7500-N or RAL 7015	neutral 1 (deep black) NCS S 9000-N or RAL 9017



1120/1121
neutral 10 (active white)



1119
neutral 9 (white-grey)



1118
neutral 8 (light-grey)



1117
neutral 7 (pebble-grey)



1116
neutral 6 (pearl grey)



1115
neutral 5 (basalt-grey)



1114
neutral 4 (graphite-black)



1113
neutral 3 (asphalt black)



1112
neutral 2 (anthracite)



1111
neutral 1 (deep black)



1004
dark azure



1003
medium azure



1002
light azure



1001
active azure



1008
dark blue



1007
medium blue

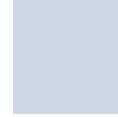

1006
light blue



1005
active blue



1012
dark turquoise



1011
medium turquoise



1010
light turquoise



1009
active turquoise



1016
dark green



1015
medium green



1014
light green



1013
active green



1020
dark yellow



1019
medium yellow



1018
light yellow



1017
active yellow



1024
dark ochre



1023
medium ochre



1022
light ochre



1021
active ochre



1028
dark salmon



1027
medium salmon



1026
light salmon



1025
active salmon



1032
dark oxide red



1031
medium oxide red



1030
light oxide red



1029
active oxide red



1036
dark stone grey



1035
medium stone grey



1034
light stone grey



1033
active stone grey



1040
dark sand grey



1039
medium sand grey



1038
light sand grey



1037
active sand grey

Formats – Earthenware



Wall tile 10 x 20 cm
4 x 8 in, smooth



Wall tile 15 x 15 cm
6 x 6 in, smooth

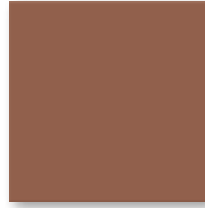

Wall tile 20 x 20 cm
8 x 8 in, smooth

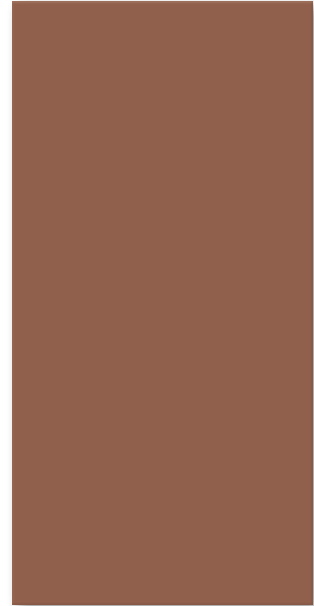

Wall tile 30 x 60 cm
12 x 24 in, smooth



Wall tile 10 x 30 cm
4 x 12 in, smooth

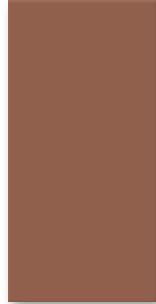

Wall tile 15 x 30 cm
6 x 12 in, smooth

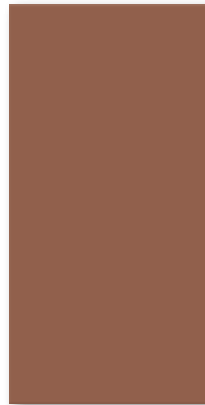

Wall tile 20 x 40 cm
8 x 16 in, smooth



Wall tile 10 x 40 cm
4 x 16 in, smooth

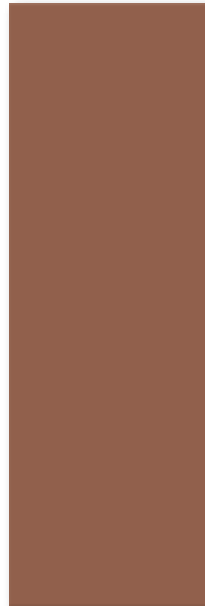

Wall tile 20 x 60 cm
8 x 24 in, smooth



Wall tile 10 x 60 cm
4 x 24 in, smooth

Wall Tiles

10 x 20 cm



10 x 30 cm



10 x 40 cm



10 x 60 cm

15 x 15 cm^{2/3}15 x 15 cm²15 x 30 cm²

Nom. dim. - cm/in	10 x 20 / 4 x 8	10 x 30 / 4 x 12	10 x 40 / 4 x 16	10 x 60 / 4 x 24	15 x 15 / 6 x 6	15 x 15 / 6 x 6	15 x 30 / 6 x 12
Work size	97 x 197 x 6.5 mm	97 x 297 x 9 mm	97 x 397 x 7.5 mm	97 x 597 x 9 mm	147 x 147 x 6.5 mm	147 x 147 x 6.5 mm	147 x 297 x 6.5 mm
Surface	silky-matt, for op-theat.	silky-matt, for op-theat.	silky-matt, for op-theat.	silky-matt, for op-theat.	glossy	glossy	silky-matt, for op-theat.
m ² - pieces	50.000	33.333	25.000	16.667	44.000	44.000	22.222
m ² - kg	11.050	14.100	13.375	14.084	10.780	10.780	10.622
Bundle - pieces	33	16	12	16	44	44	24
Bundle - m ²	0.660	0.480	0.480	0.960	1.000	1.000	1.080
Bundle - kg	7.293	6.768	6.420	13.520	10.780	10.780	11.472
Pallet - m ²	59.400	65.281	46.080	38.399	100.000	100.000	91.801
Pallet - kg	656.370	920.448	616.320	540.800	1,078.000	1,078.000	975.120
Product standard	BIII	BIII	BIII	BIII	BIII	BIII	BIII
neutral 10 (active white glossy)	120-1121H³ Price gr. A157 (m ²)	113-1121H³ Price gr. A121 (m ²)	140-1121H³ Price gr. A121 (m ²)	160-1121H³ Price gr. A154 (m ²)	115-1121H³ Price gr. A70 (m ²)		130-1121H³ Price gr. A100 (m ²)
neutral 10 (active white)	120-1120H Price gr. A157 (m ²)	113-1120H Price gr. A121 (m ²)	140-1120H Price gr. A121 (m ²)	160-1120H Price gr. A154 (m ²)		116-1120H Price gr. A70 (m ²)	130-1120H Price gr. A100 (m ²)
neutral 9 (white grey)	120-1119H Price gr. A178 (m ²)	113-1119H¹ Price gr. A169 (m ²)	140-1119H Price gr. A148 (m ²)	160-1119H Price gr. A169 (m ²)	115-1119H Price gr. A94 (m ²)	116-1119H Price gr. A94 (m ²)	130-1119H Price gr. A121 (m ²)
neutral 8 (light-grey)	120-1118H¹ Price gr. A211 (m ²)	113-1118H¹ Price gr. A169 (m ²)	140-1118H¹ Price gr. A169 (m ²)	160-1118H¹ Price gr. A199 (m ²)	115-1118H¹ Price gr. A121 (m ²)	116-1118H Price gr. A70 (m ²)	130-1118H¹ Price gr. A148 (m ²)
neutral 7 (pebble grey)	120-1117H Price gr. A178 (m ²)	113-1117H¹ Price gr. A169 (m ²)	140-1117H Price gr. A148 (m ²)	160-1117H Price gr. A169 (m ²)	115-1117H Price gr. A94 (m ²)	116-1117H Price gr. A94 (m ²)	130-1117H Price gr. A121 (m ²)
neutral 6 (pearl grey)	120-1116H¹ Price gr. A211 (m ²)	113-1116H¹ Price gr. A169 (m ²)	140-1116H¹ Price gr. A169 (m ²)	160-1116H¹ Price gr. A199 (m ²)	115-1116H¹ Price gr. A121 (m ²)	116-1116H Price gr. A94 (m ²)	130-1116H¹ Price gr. A148 (m ²)
neutral 5 (basalt grey)	120-1115H Price gr. A178 (m ²)	113-1115H¹ Price gr. A169 (m ²)	140-1115H Price gr. A148 (m ²)	160-1115H Price gr. A169 (m ²)	115-1115H Price gr. A94 (m ²)	116-1115H Price gr. A94 (m ²)	130-1115H Price gr. A121 (m ²)
neutral 4 (graphite black)	120-1114H¹ Price gr. A211 (m ²)	113-1114H¹ Price gr. A169 (m ²)	140-1114H¹ Price gr. A169 (m ²)	160-1114H¹ Price gr. A199 (m ²)	115-1114H¹ Price gr. A121 (m ²)	116-1114H Price gr. A94 (m ²)	130-1114H¹ Price gr. A148 (m ²)
neutral 3 (asphalt black)	120-1113H Price gr. A178 (m ²)	113-1113H¹ Price gr. A169 (m ²)	140-1113H Price gr. A148 (m ²)	160-1113H Price gr. A169 (m ²)	115-1113H Price gr. A94 (m ²)	116-1113H Price gr. A94 (m ²)	130-1113H Price gr. A121 (m ²)
neutral 2 (anthracite)	120-1112H¹ Price gr. A211 (m ²)	113-1112H¹ Price gr. A169 (m ²)	140-1112H¹ Price gr. A169 (m ²)	160-1112H¹ Price gr. A199 (m ²)	115-1112H¹ Price gr. A121 (m ²)	116-1112H Price gr. A94 (m ²)	130-1112H¹ Price gr. A121 (m ²)
neutral 1 (deep black)	120-1111H Price gr. A178 (m ²)	113-1111H¹ Price gr. A169 (m ²)	140-1111H Price gr. A148 (m ²)	160-1111H Price gr. A169 (m ²)	115-1111H Price gr. A94 (m ²)	116-1111H Price gr. A94 (m ²)	130-1111H Price gr. A121 (m ²)
active azure	120-1001H¹ Price gr. A211 (m ²)	113-1001H¹ Price gr. A169 (m ²)	140-1001H¹ Price gr. A169 (m ²)	160-1001H¹ Price gr. A199 (m ²)	115-1001H¹ Price gr. A121 (m ²)	116-1001H¹ Price gr. A121 (m ²)	130-1001H¹ Price gr. A148 (m ²)
light azure	120-1002H¹ Price gr. A211 (m ²)	113-1002H¹ Price gr. A169 (m ²)	140-1002H¹ Price gr. A169 (m ²)	160-1002H¹ Price gr. A199 (m ²)	115-1002H¹ Price gr. A121 (m ²)	116-1002H Price gr. A94 (m ²)	130-1002H¹ Price gr. A148 (m ²)
medium azure	120-1003H¹ Price gr. A211 (m ²)	113-1003H¹ Price gr. A169 (m ²)	140-1003H¹ Price gr. A169 (m ²)	160-1003H¹ Price gr. A199 (m ²)	115-1003H¹ Price gr. A121 (m ²)	116-1003H¹ Price gr. A121 (m ²)	130-1003H¹ Price gr. A148 (m ²)
dark azure	120-1004H Price gr. A178 (m ²)	113-1004H¹ Price gr. A169 (m ²)	140-1004H Price gr. A148 (m ²)	160-1004H Price gr. A169 (m ²)	115-1004H Price gr. A94 (m ²)	116-1004H Price gr. A94 (m ²)	130-1004H Price gr. A121 (m ²)
active blue	120-1005H¹ Price gr. A211 (m ²)	113-1005H¹ Price gr. A169 (m ²)	140-1005H¹ Price gr. A169 (m ²)	160-1005H¹ Price gr. A199 (m ²)	115-1005H¹ Price gr. A121 (m ²)	116-1005H¹ Price gr. A121 (m ²)	130-1005H¹ Price gr. A148 (m ²)
light blue	120-1006H¹ Price gr. A211 (m ²)	113-1006H¹ Price gr. A169 (m ²)	140-1006H¹ Price gr. A169 (m ²)	160-1006H¹ Price gr. A199 (m ²)	115-1006H¹ Price gr. A121 (m ²)	116-1006H Price gr. A94 (m ²)	130-1006H¹ Price gr. A148 (m ²)
medium blue	120-1007H¹ Price gr. A211 (m ²)	113-1007H¹ Price gr. A169 (m ²)	140-1007H¹ Price gr. A169 (m ²)	160-1007H¹ Price gr. A199 (m ²)	115-1007H¹ Price gr. A121 (m ²)	116-1007H¹ Price gr. A121 (m ²)	130-1007H¹ Price gr. A148 (m ²)
dark blue	120-1008H Price gr. A178 (m ²)	113-1008H¹ Price gr. A169 (m ²)	140-1008H Price gr. A148 (m ²)	160-1008H Price gr. A169 (m ²)	115-1008H Price gr. A94 (m ²)	116-1008H Price gr. A94 (m ²)	130-1008H Price gr. A121 (m ²)
active turquoise	120-1009H¹ Price gr. A211 (m ²)	113-1009H¹ Price gr. A169 (m ²)	140-1009H¹ Price gr. A169 (m ²)	160-1009H¹ Price gr. A199 (m ²)	115-1009H¹ Price gr. A121 (m ²)	116-1009H¹ Price gr. A121 (m ²)	130-1009H¹ Price gr. A148 (m ²)
light turquoise	120-1010H¹ Price gr. A211 (m ²)	113-1010H¹ Price gr. A169 (m ²)	140-1010H¹ Price gr. A169 (m ²)	160-1010H¹ Price gr. A199 (m ²)	115-1010H¹ Price gr. A121 (m ²)	116-1010H Price gr. A94 (m ²)	130-1010H¹ Price gr. A148 (m ²)
medium turquoise	120-1011H¹ Price gr. A211 (m ²)	113-1011H¹ Price gr. A169 (m ²)	140-1011H¹ Price gr. A169 (m ²)	160-1011H¹ Price gr. A199 (m ²)	115-1011H¹ Price gr. A121 (m ²)	116-1011H¹ Price gr. A121 (m ²)	130-1011H¹ Price gr. A148 (m ²)
dark turquoise	120-1012H Price gr. A178 (m ²)	113-1012H¹ Price gr. A169 (m ²)	140-1012H Price gr. A148 (m ²)	160-1012H Price gr. A169 (m ²)	115-1012H Price gr. A94 (m ²)	116-1012H Price gr. A94 (m ²)	130-1012H Price gr. A121 (m ²)
active green	120-1013H¹ Price gr. A211 (m ²)	113-1013H¹ Price gr. A169 (m ²)	140-1013H¹ Price gr. A169 (m ²)	160-1013H¹ Price gr. A199 (m ²)	115-1013H¹ Price gr. A121 (m ²)	116-1013H¹ Price gr. A121 (m ²)	130-1013H¹ Price gr. A148 (m ²)
light green	120-1014H¹ Price gr. A211 (m ²)	113-1014H¹ Price gr. A169 (m ²)	140-1014H¹ Price gr. A169 (m ²)	160-1014H¹ Price gr. A199 (m ²)	115-1014H¹ Price gr. A121 (m ²)	116-1014H Price gr. A94 (m ²)	130-1014H¹ Price gr. A148 (m ²)
medium green	120-1015H¹ Price gr. A211 (m ²)	113-1015H¹ Price gr. A169 (m ²)	140-1015H¹ Price gr. A169 (m ²)	160-1015H¹ Price gr. A199 (m ²)	115-1015H¹ Price gr. A121 (m ²)	116-1015H¹ Price gr. A121 (m ²)	130-1015H¹ Price gr. A148 (m ²)
dark green	120-1016H Price gr. A178 (m ²)	113-1016H¹ Price gr. A169 (m ²)	140-1016H Price gr. A148 (m ²)	160-1016H Price gr. A169 (m ²)	115-1016H Price gr. A94 (m ²)	116-1016H Price gr. A94 (m ²)	130-1016H Price gr. A121 (m ²)

1

Make-to-order production: return and/or cancellation of ordered products not possible.

2

One overglazed head edge 10% per delivery. Edges overglazed 2/3 each.

3

Not suitable for operating theatres.**All products: Color Shade Variation V0**

Wall Tiles

20 x 20 cm²



20 x 40 cm²



20 x 60 cm



30 x 60 cm



			20 x 20 / 8 x 8	20 x 40 / 8 x 16	20 x 60 / 8 x 24	30 x 60 / 12 x 24	Nom. dim. - cm/in
			197 x 197 x 6.5 mm	197 x 397 x 7.5 mm	197 x 597 x 9 mm	297 x 597 x 9 mm	Work size
			silky-matt, for op-theat.	silky-matt, for op-theat.	silky-matt, for op-theat.	silky-matt, for op-theat.	Surface
			25.000	12.500	8.333	5.556	m ² - pieces
			10.900	12.975	15.516	14.946	m ² - kg
			25	16	8	9	Bundle - pieces
			1.000	1.280	0.960	1.620	Bundle - m ²
			10.900	16.608	14.896	24.210	Bundle - kg
			96.000	92.160	61.442	77.754	Pallet - m ²
			1,046.400	1,195.776	953.344	1,162.080	Pallet - kg
			BIII	BIII	BIII	BIII	Product standard
			220-1121H³	240-1121H³	260-1121H³	360-1121H³	neutral 10
			Price gr. A70 (m ²)	Price gr. A100 (m ²)	Price gr. A88 (m ²)	Price gr. A88 (m ²)	(active white glossy)
			220-1120H	240-1120H	260-1120H	360-1120H	neutral 10
			Price gr. A70 (m ²)	Price gr. A100 (m ²)	Price gr. A88 (m ²)	Price gr. A88 (m ²)	(active white)
			220-1119H	240-1119H	260-1119H	360-1119H	neutral 9
			Price gr. A94 (m ²)	Price gr. A121 (m ²)	Price gr. A109 (m ²)	Price gr. A109 (m ²)	(white grey)
			220-1118H	240-1118H¹	260-1118H¹	360-1118H	neutral 8
			Price gr. A70 (m ²)	Price gr. A148 (m ²)	Price gr. A136 (m ²)	Price gr. A109 (m ²)	(light-grey)
			220-1117H	240-1117H	260-1117H	360-1117H	neutral 7
			Price gr. A94 (m ²)	Price gr. A121 (m ²)	Price gr. A109 (m ²)	Price gr. A109 (m ²)	(pebble grey)
			220-1116H	240-1116H¹	260-1116H¹	360-1116H¹	neutral 6
			Price gr. A94 (m ²)	Price gr. A148 (m ²)	Price gr. A136 (m ²)	Price gr. A136 (m ²)	(pearl grey)
			220-1115H	240-1115H	260-1115H	360-1115H	neutral 5
			Price gr. A94 (m ²)	Price gr. A121 (m ²)	Price gr. A109 (m ²)	Price gr. A109 (m ²)	(basalt grey)
			220-1114H	240-1114H¹	260-1114H¹	360-1114H¹	neutral 4
			Price gr. A94 (m ²)	Price gr. A148 (m ²)	Price gr. A136 (m ²)	Price gr. A136 (m ²)	(graphite black)
			220-1113H	240-1113H	260-1113H	360-1113H	neutral 3
			Price gr. A94 (m ²)	Price gr. A121 (m ²)	Price gr. A109 (m ²)	Price gr. A109 (m ²)	(asphalt black)
			220-1112H	240-1112H¹	260-1112H¹	360-1112H¹	neutral 2
			Price gr. A94 (m ²)	Price gr. A148 (m ²)	Price gr. A136 (m ²)	Price gr. A136 (m ²)	(anthracite)
			220-1111H	240-1111H	260-1111H	360-1111H	neutral 1
			Price gr. A94 (m ²)	Price gr. A121 (m ²)	Price gr. A109 (m ²)	Price gr. A109 (m ²)	(deep black)
			220-1001H¹	240-1001H¹	260-1001H¹	360-1001H¹	active azure
			Price gr. A121 (m ²)	Price gr. A148 (m ²)	Price gr. A136 (m ²)	Price gr. A136 (m ²)	
			220-1002H	240-1002H	260-1002H¹	360-1002H¹	light azure
			Price gr. A94 (m ²)	Price gr. A121 (m ²)	Price gr. A136 (m ²)	Price gr. A136 (m ²)	
			220-1003H¹	240-1003H¹	260-1003H¹	360-1003H¹	medium azure
			Price gr. A121 (m ²)	Price gr. A148 (m ²)	Price gr. A136 (m ²)	Price gr. A136 (m ²)	
			220-1004H	240-1004H	260-1004H	360-1004H	dark azure
			Price gr. A94 (m ²)	Price gr. A121 (m ²)	Price gr. A109 (m ²)	Price gr. A109 (m ²)	
			220-1005H¹	240-1005H¹	260-1005H¹	360-1005H¹	active blue
			Price gr. A121 (m ²)	Price gr. A148 (m ²)	Price gr. A136 (m ²)	Price gr. A136 (m ²)	
			220-1006H	240-1006H	260-1006H¹	360-1006H¹	light blue
			Price gr. A94 (m ²)	Price gr. A121 (m ²)	Price gr. A136 (m ²)	Price gr. A136 (m ²)	
			220-1007H¹	240-1007H¹	260-1007H¹	360-1007H¹	medium blue
			Price gr. A121 (m ²)	Price gr. A148 (m ²)	Price gr. A136 (m ²)	Price gr. A136 (m ²)	
			220-1008H	240-1008H	260-1008H	360-1008H	dark blue
			Price gr. A94 (m ²)	Price gr. A121 (m ²)	Price gr. A109 (m ²)	Price gr. A109 (m ²)	
			220-1009H¹	240-1009H¹	260-1009H¹	360-1009H¹	active turquoise
			Price gr. A121 (m ²)	Price gr. A148 (m ²)	Price gr. A136 (m ²)	Price gr. A136 (m ²)	
			220-1010H	240-1010H	260-1010H¹	360-1010H¹	light turquoise
			Price gr. A94 (m ²)	Price gr. A121 (m ²)	Price gr. A136 (m ²)	Price gr. A136 (m ²)	
			220-1011H¹	240-1011H¹	260-1011H¹	360-1011H¹	medium turquoise
			Price gr. A121 (m ²)	Price gr. A148 (m ²)	Price gr. A136 (m ²)	Price gr. A136 (m ²)	
			220-1012H	240-1012H	260-1012H	360-1012H	dark turquoise
			Price gr. A94 (m ²)	Price gr. A121 (m ²)	Price gr. A109 (m ²)	Price gr. A109 (m ²)	
			220-1013H¹	240-1013H¹	260-1013H¹	360-1013H¹	active green
			Price gr. A121 (m ²)	Price gr. A148 (m ²)	Price gr. A136 (m ²)	Price gr. A136 (m ²)	
			220-1014H	240-1014H	260-1014H¹	360-1014H¹	light green
			Price gr. A94 (m ²)	Price gr. A121 (m ²)	Price gr. A136 (m ²)	Price gr. A136 (m ²)	
			220-1015H¹	240-1015H¹	260-1015H¹	360-1015H¹	medium green
			Price gr. A121 (m ²)	Price gr. A148 (m ²)	Price gr. A136 (m ²)	Price gr. A136 (m ²)	
			220-1016H	240-1016H	260-1016H	360-1016H	dark green
			Price gr. A94 (m ²)	Price gr. A121 (m ²)	Price gr. A109 (m ²)	Price gr. A109 (m ²)	

¹ Make-to-order production: return and/or cancellation of ordered products not possible.

² One overglazed head edge 10% per delivery. Edges overglazed 2/3 each.

³ Not suitable for operating theatres.

Wall Tiles

10 x 20 cm



10 x 30 cm



10 x 40 cm



10 x 60 cm



15 x 15 cm^{2/3}



15 x 15 cm²



15 x 30 cm²



Nom. dim. - cm/in	10 x 20 / 4 x 8	10 x 30 / 4 x 12	10 x 40 / 4 x 16	10 x 60 / 4 x 24	15 x 15 / 6 x 6	15 x 15 / 6 x 6	15 x 30 / 6 x 12
Work size	97 x 197 x 6.5 mm	97 x 297 x 9 mm	97 x 397 x 7.5 mm	97 x 597 x 9 mm	147 x 147 x 6.5 mm	147 x 147 x 6.5 mm	147 x 297 x 6.5 mm
Surface	silky-matt, for op-theat.	silky-matt, for op-theat.	silky-matt, for op-theat.	silky-matt, for op-theat.	glossy	glossy	silky-matt, for op-theat.
m ² - pieces	50.000	33.333	25.000	16.667	44.000	44.000	22.222
m ² - kg	11.050	14.100	13.375	14.084	10.780	10.780	10.622
Bundle - pieces	33	16	12	16	44	44	24
Bundle - m ²	0.660	0.480	0.480	0.960	1.000	1.000	1.080
Bundle - kg	7.293	6.768	6.420	13.520	10.780	10.780	11.472
Pallet - m ²	59.400	65.281	46.080	38.399	100.000	100.000	91.801
Pallet - kg	656.370	920.448	616.320	540.800	1,078.000	1,078.000	975.120
Product standard	BIII	BIII	BIII	BIII	BIII	BIII	BIII
active yellow	120-1017H ¹ Price gr. A211 (m ²)	113-1017H ¹ Price gr. A169 (m ²)	140-1017H ¹ Price gr. A169 (m ²)	160-1017H ¹ Price gr. A199 (m ²)	115-1017H ¹ Price gr. A121 (m ²)	116-1017H ¹ Price gr. A121 (m ²)	130-1017H ¹ Price gr. A148 (m ²)
light yellow	120-1018H ¹ Price gr. A211 (m ²)	113-1018H ¹ Price gr. A169 (m ²)	140-1018H ¹ Price gr. A169 (m ²)	160-1018H ¹ Price gr. A199 (m ²)	115-1018H ¹ Price gr. A121 (m ²)	116-1018H ¹ Price gr. A94 (m ²)	130-1018H ¹ Price gr. A148 (m ²)
medium yellow	120-1019H ¹ Price gr. A211 (m ²)	113-1019H ¹ Price gr. A169 (m ²)	140-1019H ¹ Price gr. A169 (m ²)	160-1019H ¹ Price gr. A199 (m ²)	115-1019H ¹ Price gr. A121 (m ²)	116-1019H ¹ Price gr. A121 (m ²)	130-1019H ¹ Price gr. A148 (m ²)
dark yellow	120-1020H ¹ Price gr. A178 (m ²)	113-1020H ¹ Price gr. A169 (m ²)	140-1020H ¹ Price gr. A148 (m ²)	160-1020H ¹ Price gr. A169 (m ²)	115-1020H ¹ Price gr. A94 (m ²)	116-1020H ¹ Price gr. A94 (m ²)	130-1020H ¹ Price gr. A121 (m ²)
active ochre	120-1021H ¹ Price gr. A211 (m ²)	113-1021H ¹ Price gr. A169 (m ²)	140-1021H ¹ Price gr. A169 (m ²)	160-1021H ¹ Price gr. A199 (m ²)	115-1021H ¹ Price gr. A121 (m ²)	116-1021H ¹ Price gr. A121 (m ²)	130-1021H ¹ Price gr. A148 (m ²)
light ochre	120-1022H ¹ Price gr. A211 (m ²)	113-1022H ¹ Price gr. A169 (m ²)	140-1022H ¹ Price gr. A169 (m ²)	160-1022H ¹ Price gr. A199 (m ²)	115-1022H ¹ Price gr. A121 (m ²)	116-1022H ¹ Price gr. A94 (m ²)	130-1022H ¹ Price gr. A148 (m ²)
medium ochre	120-1023H ¹ Price gr. A211 (m ²)	113-1023H ¹ Price gr. A169 (m ²)	140-1023H ¹ Price gr. A169 (m ²)	160-1023H ¹ Price gr. A199 (m ²)	115-1023H ¹ Price gr. A121 (m ²)	116-1023H ¹ Price gr. A121 (m ²)	130-1023H ¹ Price gr. A148 (m ²)
dark ochre	120-1024H ¹ Price gr. A178 (m ²)	113-1024H ¹ Price gr. A169 (m ²)	140-1024H ¹ Price gr. A148 (m ²)	160-1024H ¹ Price gr. A169 (m ²)	115-1024H ¹ Price gr. A94 (m ²)	116-1024H ¹ Price gr. A94 (m ²)	130-1024H ¹ Price gr. A121 (m ²)
active salmon	120-1025H ¹ Price gr. A211 (m ²)	113-1025H ¹ Price gr. A169 (m ²)	140-1025H ¹ Price gr. A169 (m ²)	160-1025H ¹ Price gr. A199 (m ²)	115-1025H ¹ Price gr. A121 (m ²)	116-1025H ¹ Price gr. A121 (m ²)	130-1025H ¹ Price gr. A148 (m ²)
light salmon	120-1026H ¹ Price gr. A211 (m ²)	113-1026H ¹ Price gr. A169 (m ²)	140-1026H ¹ Price gr. A169 (m ²)	160-1026H ¹ Price gr. A199 (m ²)	115-1026H ¹ Price gr. A121 (m ²)	116-1026H ¹ Price gr. A94 (m ²)	130-1026H ¹ Price gr. A148 (m ²)
medium salmon	120-1027H ¹ Price gr. A211 (m ²)	113-1027H ¹ Price gr. A169 (m ²)	140-1027H ¹ Price gr. A169 (m ²)	160-1027H ¹ Price gr. A199 (m ²)	115-1027H ¹ Price gr. A121 (m ²)	116-1027H ¹ Price gr. A121 (m ²)	130-1027H ¹ Price gr. A148 (m ²)
dark salmon	120-1028H ¹ Price gr. A178 (m ²)	113-1028H ¹ Price gr. A169 (m ²)	140-1028H ¹ Price gr. A148 (m ²)	160-1028H ¹ Price gr. A169 (m ²)	115-1028H ¹ Price gr. A94 (m ²)	116-1028H ¹ Price gr. A94 (m ²)	130-1028H ¹ Price gr. A121 (m ²)
active oxide red	120-1029H ¹ Price gr. A211 (m ²)	113-1029H ¹ Price gr. A169 (m ²)	140-1029H ¹ Price gr. A169 (m ²)	160-1029H ¹ Price gr. A199 (m ²)	115-1029H ¹ Price gr. A121 (m ²)	116-1029H ¹ Price gr. A121 (m ²)	130-1029H ¹ Price gr. A148 (m ²)
light oxide red	120-1030H ¹ Price gr. A211 (m ²)	113-1030H ¹ Price gr. A169 (m ²)	140-1030H ¹ Price gr. A169 (m ²)	160-1030H ¹ Price gr. A199 (m ²)	115-1030H ¹ Price gr. A121 (m ²)	116-1030H ¹ Price gr. A94 (m ²)	130-1030H ¹ Price gr. A148 (m ²)
medium oxide red	120-1031H ¹ Price gr. A211 (m ²)	113-1031H ¹ Price gr. A169 (m ²)	140-1031H ¹ Price gr. A169 (m ²)	160-1031H ¹ Price gr. A199 (m ²)	115-1031H ¹ Price gr. A121 (m ²)	116-1031H ¹ Price gr. A121 (m ²)	130-1031H ¹ Price gr. A148 (m ²)
dark oxide red	120-1032H ¹ Price gr. A178 (m ²)	113-1032H ¹ Price gr. A169 (m ²)	140-1032H ¹ Price gr. A148 (m ²)	160-1032H ¹ Price gr. A169 (m ²)	115-1032H ¹ Price gr. A94 (m ²)	116-1032H ¹ Price gr. A94 (m ²)	130-1032H ¹ Price gr. A121 (m ²)
active stone grey	120-1033H ¹ Price gr. A211 (m ²)	113-1033H ¹ Price gr. A169 (m ²)	140-1033H ¹ Price gr. A169 (m ²)	160-1033H ¹ Price gr. A199 (m ²)	115-1033H ¹ Price gr. A121 (m ²)	116-1033H ¹ Price gr. A121 (m ²)	130-1033H ¹ Price gr. A148 (m ²)
light stone grey	120-1034H ¹ Price gr. A211 (m ²)	113-1034H ¹ Price gr. A169 (m ²)	140-1034H ¹ Price gr. A169 (m ²)	160-1034H ¹ Price gr. A199 (m ²)	115-1034H ¹ Price gr. A121 (m ²)	116-1034H ¹ Price gr. A94 (m ²)	130-1034H ¹ Price gr. A148 (m ²)
medium stone grey	120-1035H ¹ Price gr. A211 (m ²)	113-1035H ¹ Price gr. A169 (m ²)	140-1035H ¹ Price gr. A169 (m ²)	160-1035H ¹ Price gr. A199 (m ²)	115-1035H ¹ Price gr. A121 (m ²)	116-1035H ¹ Price gr. A121 (m ²)	130-1035H ¹ Price gr. A148 (m ²)
dark stone grey	120-1036H ¹ Price gr. A178 (m ²)	113-1036H ¹ Price gr. A169 (m ²)	140-1036H ¹ Price gr. A148 (m ²)	160-1036H ¹ Price gr. A169 (m ²)	115-1036H ¹ Price gr. A94 (m ²)	116-1036H ¹ Price gr. A94 (m ²)	130-1036H ¹ Price gr. A121 (m ²)
active sand-grey	120-1037H ¹ Price gr. A211 (m ²)	113-1037H ¹ Price gr. A169 (m ²)	140-1037H ¹ Price gr. A169 (m ²)	160-1037H ¹ Price gr. A199 (m ²)	115-1037H ¹ Price gr. A121 (m ²)	116-1037H ¹ Price gr. A121 (m ²)	130-1037H ¹ Price gr. A148 (m ²)
light sand-grey	120-1038H ¹ Price gr. A211 (m ²)	113-1038H ¹ Price gr. A148 (m ²)	140-1038H ¹ Price gr. A148 (m ²)	160-1038H ¹ Price gr. A199 (m ²)	115-1038H ¹ Price gr. A94 (m ²)	116-1038H ¹ Price gr. A94 (m ²)	130-1038H ¹ Price gr. A121 (m ²)
medium sand-grey	120-1039H ¹ Price gr. A211 (m ²)	113-1039H ¹ Price gr. A169 (m ²)	140-1039H ¹ Price gr. A169 (m ²)	160-1039H ¹ Price gr. A199 (m ²)	115-1039H ¹ Price gr. A121 (m ²)	116-1039H ¹ Price gr. A121 (m ²)	130-1039H ¹ Price gr. A121 (m ²)
dark sand-grey	120-1040H ¹ Price gr. A178 (m ²)	113-1040H ¹ Price gr. A169 (m ²)	140-1040H ¹ Price gr. A148 (m ²)	160-1040H ¹ Price gr. A169 (m ²)	115-1040H ¹ Price gr. A94 (m ²)	116-1040H ¹ Price gr. A94 (m ²)	130-1040H ¹ Price gr. A121 (m ²)

¹ Make-to-order production: return and/or cancellation of ordered products not possible.

² One overglazed head edge 10% per delivery. Edges overglazed 2/3 each.

³ Not suitable for operating theatres.

All products: Color Shade Variation V0

Wall Tiles

20 x 20 cm²



20 x 40 cm²

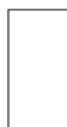

20 x 60 cm



30 x 60 cm



			20 x 20 / 8 x 8	20 x 40 / 8 x 16	20 x 60 / 8 x 24	30 x 60 / 12 x 24	Nom. dim. - cm/in
			197 x 197 x 6.5 mm	197 x 397 x 7.5 mm	197 x 597 x 9 mm	297 x 597 x 9 mm	Work size
			silky-matt, for op-theat.	silky-matt, for op-theat.	silky-matt, for op-theat.	silky-matt, for op-theat.	Surface
			25.000	12.500	8.333	5.556	m ² - pieces
			10.900	12.975	15.516	14.946	m ² - kg
			25	16	8	9	Bundle - pieces
			1.000	1.280	0.960	1.620	Bundle - m ²
			10.900	16.608	14.896	24.210	Bundle - kg
			96.000	92.160	61.442	77.754	Pallet - m ²
			1,046.400	1,195.776	953.344	1,162.080	Pallet - kg
			BIII	BIII	BIII	BIII	Product standard
			220-1017H ¹	240-1017H ¹	260-1017H ¹	360-1017H ¹	active yellow
			Price gr. A121 (m ²)	Price gr. A148 (m ²)	Price gr. A136 (m ²)	Price gr. A136 (m ²)	
			220-1018H	240-1018H	260-1018H ¹	360-1018H ¹	light yellow
			Price gr. A94 (m ²)	Price gr. A121 (m ²)	Price gr. A136 (m ²)	Price gr. A136 (m ²)	
			220-1019H ¹	240-1019H ¹	260-1019H ¹	360-1019H ¹	medium yellow
			Price gr. A121 (m ²)	Price gr. A148 (m ²)	Price gr. A136 (m ²)	Price gr. A136 (m ²)	
			220-1020H	240-1020H	260-1020H	360-1020H	dark yellow
			Price gr. A94 (m ²)	Price gr. A121 (m ²)	Price gr. A109 (m ²)	Price gr. A109 (m ²)	
			220-1021H ¹	240-1021H ¹	260-1021H ¹	360-1021H ¹	active ochre
			Price gr. A121 (m ²)	Price gr. A148 (m ²)	Price gr. A136 (m ²)	Price gr. A136 (m ²)	
			220-1022H	240-1022H	260-1022H ¹	360-1022H ¹	light ochre
			Price gr. A94 (m ²)	Price gr. A121 (m ²)	Price gr. A136 (m ²)	Price gr. A136 (m ²)	
			220-1023H ¹	240-1023H ¹	260-1023H ¹	360-1023H ¹	medium ochre
			Price gr. A121 (m ²)	Price gr. A148 (m ²)	Price gr. A136 (m ²)	Price gr. A136 (m ²)	
			220-1024H	240-1024H	260-1024H	360-1024H	dark ochre
			Price gr. A94 (m ²)	Price gr. A121 (m ²)	Price gr. A109 (m ²)	Price gr. A109 (m ²)	
			220-1025H ¹	240-1025H ¹	260-1025H ¹	360-1025H ¹	active salmon
			Price gr. A121 (m ²)	Price gr. A148 (m ²)	Price gr. A136 (m ²)	Price gr. A136 (m ²)	
			220-1026H	240-1026H	260-1026H ¹	360-1026H ¹	light salmon
			Price gr. A94 (m ²)	Price gr. A121 (m ²)	Price gr. A136 (m ²)	Price gr. A136 (m ²)	
			220-1027H ¹	240-1027H ¹	260-1027H ¹	360-1027H ¹	medium salmon
			Price gr. A121 (m ²)	Price gr. A148 (m ²)	Price gr. A136 (m ²)	Price gr. A136 (m ²)	
			220-1028H	240-1028H	260-1028H	360-1028H	dark salmon
			Price gr. A94 (m ²)	Price gr. A121 (m ²)	Price gr. A109 (m ²)	Price gr. A109 (m ²)	
			220-1029H ¹	240-1029H ¹	260-1029H ¹	360-1029H ¹	active oxide red
			Price gr. A121 (m ²)	Price gr. A148 (m ²)	Price gr. A136 (m ²)	Price gr. A136 (m ²)	
			220-1030H	240-1030H	260-1030H ¹	360-1030H ¹	light oxide red
			Price gr. A94 (m ²)	Price gr. A121 (m ²)	Price gr. A136 (m ²)	Price gr. A136 (m ²)	
			220-1031H ¹	240-1031H ¹	260-1031H ¹	360-1031H ¹	medium oxide red
			Price gr. A121 (m ²)	Price gr. A148 (m ²)	Price gr. A136 (m ²)	Price gr. A136 (m ²)	
			220-1032H	240-1032H	260-1032H	360-1032H	dark oxide red
			Price gr. A94 (m ²)	Price gr. A121 (m ²)	Price gr. A109 (m ²)	Price gr. A109 (m ²)	
			220-1033H ¹	240-1033H ¹	260-1033H ¹	360-1033H ¹	active stone grey
			Price gr. A121 (m ²)	Price gr. A148 (m ²)	Price gr. A136 (m ²)	Price gr. A136 (m ²)	
			220-1034H	240-1034H	260-1034H ¹	360-1034H ¹	light stone grey
			Price gr. A94 (m ²)	Price gr. A121 (m ²)	Price gr. A136 (m ²)	Price gr. A136 (m ²)	
			220-1035H ¹	240-1035H ¹	260-1035H ¹	360-1035H ¹	medium stone grey
			Price gr. A121 (m ²)	Price gr. A148 (m ²)	Price gr. A136 (m ²)	Price gr. A136 (m ²)	
			220-1036H	240-1036H	260-1036H	360-1036H	dark stone grey
			Price gr. A94 (m ²)	Price gr. A121 (m ²)	Price gr. A109 (m ²)	Price gr. A109 (m ²)	
			220-1037H ¹	240-1037H ¹	260-1037H ¹	360-1037H ¹	active sand-grey
			Price gr. A121 (m ²)	Price gr. A148 (m ²)	Price gr. A136 (m ²)	Price gr. A136 (m ²)	
			220-1038H	240-1038H	260-1038H ¹	360-1038H	light sand-grey
			Price gr. A94 (m ²)	Price gr. A121 (m ²)	Price gr. A136 (m ²)	Price gr. A109 (m ²)	
			220-1039H	240-1039H ¹	260-1039H ¹	360-1039H ¹	medium sand-grey
			Price gr. A94 (m ²)	Price gr. A148 (m ²)	Price gr. A136 (m ²)	Price gr. A136 (m ²)	
			220-1040H	240-1040H	260-1040H	360-1040H	dark sand-grey
			Price gr. A94 (m ²)	Price gr. A121 (m ²)	Price gr. A109 (m ²)	Price gr. A109 (m ²)	

¹ Make-to-order production: return and/or cancellation of ordered products not possible.

² One overglazed head edge 10% per delivery. Edges overglazed 2/3 each.

³ Not suitable for operating theatres.

All products: Color Shade Variation V0

Plural
Contrasting colors



2120/2121/700/701
neutral 10 (active white)



2119/552119
neutral 9 (white-grey)



2118/552118
neutral 8 (light-grey)



2117/552117
neutral 7 (pebble-grey)



2116/552116
neutral 6 (pearl grey)



2115/552115
neutral 5 (basalt-grey)



2114/552114
neutral 4 (graphite-black)



2113/552113
neutral 3 (asphalt black)



2112/552112
neutral 2 (anthracite)



2112/5716
neutral 1 (deep black)



2004/552004
dark azure



2008/552008
dark blue



2012/552012
dark turquoise



2016/552016
dark green



2020/552020
dark yellow



2024/552024
dark ochre



2028/552028
dark salmon



2032/552032
dark oxide red



2036/552036
dark stone grey



2040/552040
dark sand grey



2003/552003
medium azure



2007/552007
medium blue



2011/552011
medium turquoise



2015/552015
medium green



2019/552019
medium yellow



2023/552023
medium ochre



2027/552027
medium salmon



2031/552031
medium oxide red



2035/552035
medium stone grey



2039/552039
medium sand grey



2002/552002
azur hell

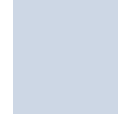

2006/552006
light blue



2010/552010
light turquoise



2014/552014
light green



2018/552018
light yellow



2022/552022
light ochre



2026/552026
light salmon



2030/552030
light oxide red



2034/552034
light stone grey



2038/552038
light sand grey



2001/552001
light azure



2005/552005
active blue



2009/552009
active turquoise



2013/552013
active green



2017/552017
active yellow



2021/552021
active ochre



2025/552025
active salmon



2029/552029
active oxide red



2033/552033
active stone grey



2037/552037
active sand grey



2504
deep anthracite



2508
deep blue



2512
deep green



2516
deep yellow



2520
deep orange



2524
deep red

Formats Stoneware

Mosaic 1 x 1 cm, 3/8 x 3/8 in

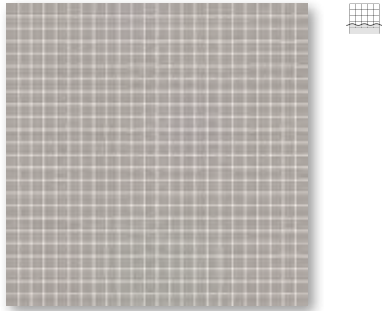

Mosaic sheet 30 x 30 cm, 12 x 12 in, smooth

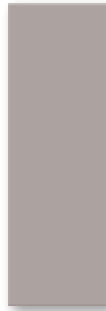

Floor/wall tile
10 x 30 cm, 4 x 12 in, smooth

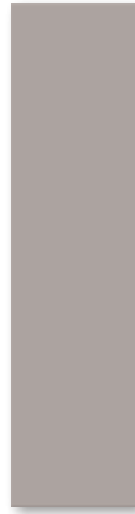

Floor/wall tile
12,5 x 50 cm, 5 x 20 in, smooth

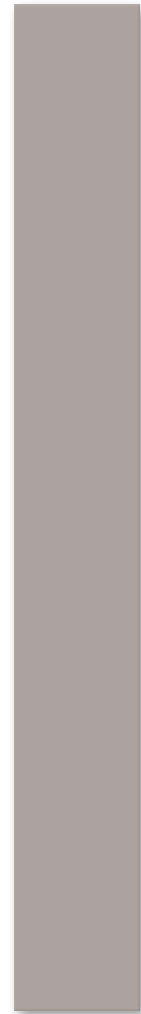

Floor/wall tile
12.5 x 100 cm, 5 x 40 in, smooth

Mosaic 2.5 x 2.5 cm, 1 x 1 in

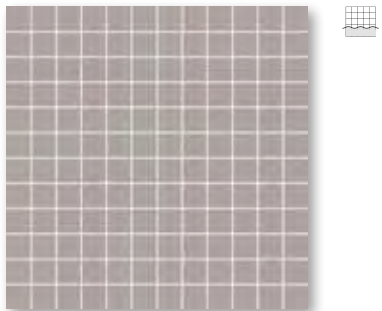

Mosaic sheet 30 x 30 cm, 12 x 12 in, smooth

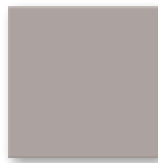

Floor/wall tile
15 x 15 cm, 6 x 6 in, smooth



Floor/wall tile
20 x 20 cm, 8 x 8 in, smooth

Mosaic 5 x 5 cm, 2 x 2 in

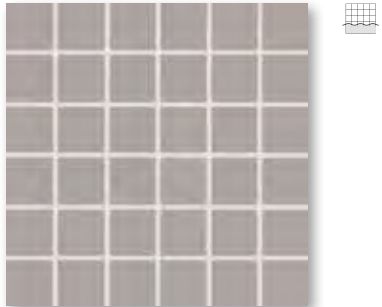

Mosaic sheet 30 x 30 cm, 12 x 12 in, smooth

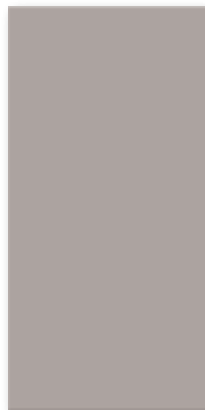

Floor/wall tile
20 x 40 cm, 8 x 16 in, smooth

Mosaic 10 x 10 cm, 4 x 4 in

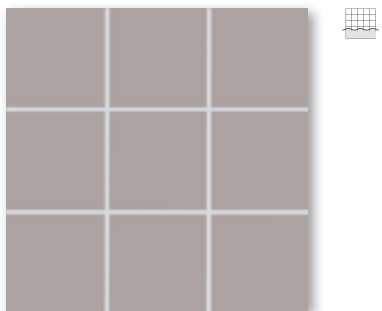

Mosaic sheet 30 x 30 cm, 12 x 12 in, smooth

Do you already know our Mosaic Designer at our website www.agrob-buchtal.de?

There, you will have the possibility of designing your individual color gradients, mosaic compositions and the laying of pictures.

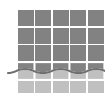

Mosaics glued thermoplastically on back of AGROB BUCHTAL can be used not only in dry zones but also without any problems in underwater areas (e.g. swimming pools/whirlpools) as well as in permanently wet areas (e.g. pool surrounds/showers).

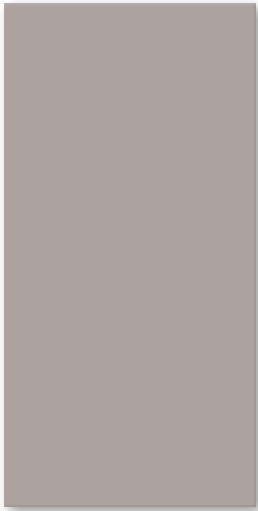

Floor/wall tile
25 x 50 cm, 10 x 20 in, smooth



Floor/wall tile
30 x 30 cm, 12 x 12 in, smooth

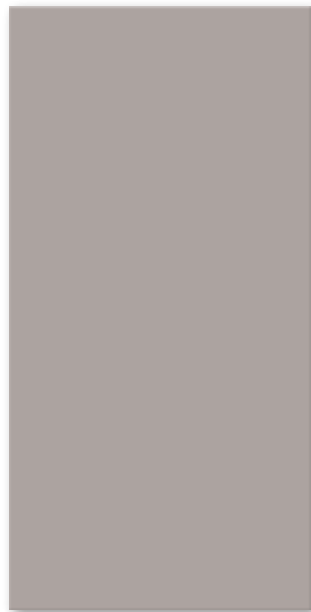

Floor/wall tile
30 x 60 cm, 12 x 24 in, smooth

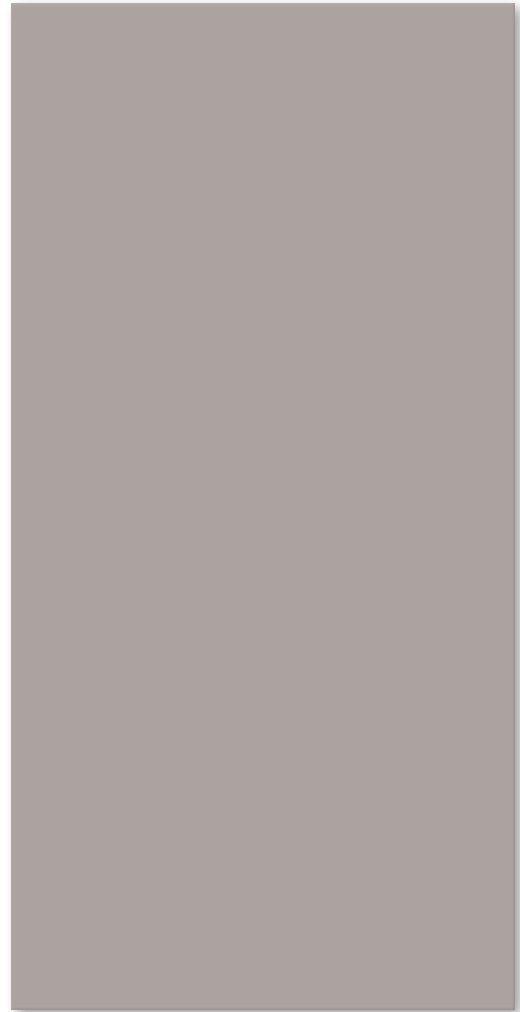

Floor/wall tile
50 x 100 cm, 20 x 40 in, smooth



Cove skirting,
smooth
10 x 10 cm
4 x 4 in, smooth



Internal
corner,
smooth



External
corner,
smooth

Mosaic

Floor/Wall Tiles

1 x 1 cm^{2/7}

2.5 x 2.5 cm^{2/7}

5 x 5 cm^{2/7}

10 x 10 cm^{2/3/7}

10 x 30 cm

12.5 x 50 cm⁵

12.5 x 100 cm⁵

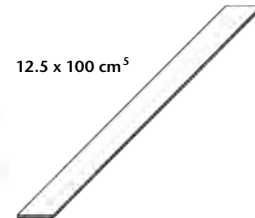
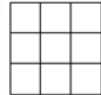
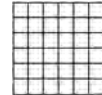
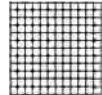
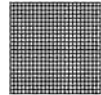

Mosaic, glued thermopl.
on back
Sheet: 313 x 313 mm

Mosaic, glued thermopl.
on back
Sheet: 297 x 297 mm

Mosaic, glued thermopl.
on back
Sheet: 297 x 297 mm

Mosaic, glued thermopl.
on back
Sheet: 297 x 297 mm



1 x 1 / 3/8 x 3/8	2.5 x 2.5 / 1 x 1	5 x 5 / 2 x 2	10 x 10 / 4 x 4	10 x 30 / 4 x 12	341550HK	352010HK	Model number
12 x 12 x 6.5 mm	23 x 23 x 6.5 mm	47 x 47 x 6.5 mm	97 x 97 x 6.5 mm	97 x 297 x 6 mm	12.5 x 50 / 5 x 20	12.5 x 100 / 5 x 40	Nom. dim. - cm/in
smooth, for op-theat.	smooth, for op-theat.	smooth, for op-theat.	smooth, for op-theat.	smooth, silky-matt ⁶	smooth, silky-matt ⁶	smooth, silky-matt ⁶	Work size
10.000 sheets	11 sheets	11 sheets	11 sheets	33.333	16.000	8.000	Surface
11.930	12.100	12.331	13.101	12.333	17.040	17.040	m ² - pieces
10 sheets	11 sheets	11 sheets	11 sheets	38	8	10	m ² - kg
1.000	1.000	1.000	1.000	1.140	0.500	1.250	Bundle - pieces
11.930	12.100	12.331	13.101	14.060	8.520	21.300	Bundle - m ²
24.000	48.000	64.000	64.000	95.761	55.000	67.500	Bundle - kg
286.320	580.800	789.184	838.464	1,181.040	937.200	1,150.200	Pallet - m ²
B1b	B1b	B1b	B1b	Alb	Alb	Alb	Pallet - kg
1 - 2	1 - 2	1 - 2	1 - 2	1 - 2	1 - 2	1 - 2	Product standard
		705-2121H ⁸	710-2121H ⁸	703-2121H ⁸	700i-341550HK ⁸	700i-352010HK ⁸	Stress group
		Price gr. A187 (m ²)	Price gr. A142 (m ²)	Price gr. A142 (m ²)	Price gr. A211 (m ²)	Price gr. A265 (m ²)	4 neutral 10
701-2120H ¹	702-2120H	705-2120H	710-2120H	703-2120H	701i-341550HK	701i-352010HK	(active white glossy)
Price gr. A361 (m ²)	Price gr. A229 (m ²)	Price gr. A187 (m ²)	Price gr. A142 (m ²)	Price gr. A142 (m ²)	Price gr. A211 (m ²)	Price gr. A265 (m ²)	4 neutral 10
701-2119H ¹	702-2119H ¹	705-2119H	710-2119H	703-2119H ¹	552119-341550HK ¹	552119-352010HK ¹	(active white)
Price gr. A361 (m ²)	Price gr. A280 (m ²)	Price gr. A211 (m ²)	Price gr. A157 (m ²)	Price gr. A187 (m ²)	Price gr. A259 (m ²)	Price gr. A313 (m ²)	4 neutral 9
701-2118H ¹	702-2118H	705-2118H	710-2118H	703-2118H	552118-341550HK	552118-352010HK	(white grey)
Price gr. A361 (m ²)	Price gr. A229 (m ²)	Price gr. A187 (m ²)	Price gr. A142 (m ²)	Price gr. A142 (m ²)	Price gr. A211 (m ²)	Price gr. A265 (m ²)	4 neutral 8
701-2117H ¹	702-2117H ¹	705-2117H	710-2117H	703-2117H ¹	552117-341550HK	552117-352010HK	(light-grey)
Price gr. A361 (m ²)	Price gr. A280 (m ²)	Price gr. A211 (m ²)	Price gr. A157 (m ²)	Price gr. A187 (m ²)	Price gr. A229 (m ²)	Price gr. A289 (m ²)	4 neutral 7
701-2116H ¹	702-2116H ¹	705-2116H ¹	710-2116H ¹	703-2116H ¹	552116-341550HK ¹	552116-352010HK ¹	(pebble grey)
Price gr. A361 (m ²)	Price gr. A280 (m ²)	Price gr. A238 (m ²)	Price gr. A187 (m ²)	Price gr. A187 (m ²)	Price gr. A259 (m ²)	Price gr. A313 (m ²)	3 neutral 6
701-2115H ¹	702-2115H ¹	705-2115H	710-2115H	703-2115H ¹	552115-341550HK ¹	552115-352010HK ¹	(pearl grey)
Price gr. A361 (m ²)	Price gr. A280 (m ²)	Price gr. A211 (m ²)	Price gr. A157 (m ²)	Price gr. A187 (m ²)	Price gr. A259 (m ²)	Price gr. A313 (m ²)	3 neutral 5
701-2114H ¹	702-2114H ¹	705-2114H	710-2114H	703-2114H ^{1/4}	552114-341550HK ^{1/4}	552114-352010HK ^{1/4}	(basalt grey)
Price gr. A361 (m ²)	Price gr. A280 (m ²)	Price gr. A211 (m ²)	Price gr. A157 (m ²)	Price gr. A187 (m ²)	Price gr. A259 (m ²)	Price gr. A313 (m ²)	3 neutral 4
701-2113H ¹	702-2113H ¹	705-2113H	710-2113H	703-2113H	552113-341550HK	552113-352010HK	(graphite black)
Price gr. A361 (m ²)	Price gr. A280 (m ²)	Price gr. A211 (m ²)	Price gr. A157 (m ²)	Price gr. A157 (m ²)	Price gr. A229 (m ²)	Price gr. A289 (m ²)	3 neutral 3
701-2112H ¹	702-2112H ¹	705-2112H	710-2112H	703-2112H ¹	552112-341550HK ¹	552112-352010HK ¹	(asphalt black)
Price gr. A361 (m ²)	Price gr. A280 (m ²)	Price gr. A211 (m ²)	Price gr. A157 (m ²)	Price gr. A187 (m ²)	Price gr. A259 (m ²)	Price gr. A313 (m ²)	2 neutral 2
701-2111H ¹	702-2111H	705-2111H	710-2111H	703-2111H ⁴	5716-341550HK ^{1/4}	5716-352010HK ^{1/4}	(anthracite)
Price gr. A361 (m ²)	Price gr. A250 (m ²)	Price gr. A211 (m ²)	Price gr. A157 (m ²)	Price gr. A187 (m ²)	Price gr. A259 (m ²)	Price gr. A313 (m ²)	1 neutral 1
701-2001H ¹	702-2001H ¹	705-2001H	710-2001H	703-2001H	552001-341550HK	552001-352010HK	(deep black)
Price gr. A361 (m ²)	Price gr. A280 (m ²)	Price gr. A211 (m ²)	Price gr. A157 (m ²)	Price gr. A157 (m ²)	Price gr. A229 (m ²)	Price gr. A289 (m ²)	2 active azure
701-2002H ¹	702-2002H ¹	705-2002H	710-2002H	703-2002H ¹	552002-341550HK ¹	552002-352010HK ¹	active azure
Price gr. A361 (m ²)	Price gr. A280 (m ²)	Price gr. A211 (m ²)	Price gr. A157 (m ²)	Price gr. A187 (m ²)	Price gr. A259 (m ²)	Price gr. A313 (m ²)	4 light azure
701-2003H ¹	702-2003H	705-2003H	710-2003H	703-2003H	552003-341550HK	552003-352010HK	light azure
Price gr. A361 (m ²)	Price gr. A250 (m ²)	Price gr. A211 (m ²)	Price gr. A157 (m ²)	Price gr. A157 (m ²)	Price gr. A229 (m ²)	Price gr. A289 (m ²)	3 medium azure
701-2004H ¹	702-2004H	705-2004H	710-2004H	703-2004H ¹	552004-341550HK ¹	552004-352010HK ¹	medium azure
Price gr. A361 (m ²)	Price gr. A250 (m ²)	Price gr. A211 (m ²)	Price gr. A157 (m ²)	Price gr. A187 (m ²)	Price gr. A259 (m ²)	Price gr. A313 (m ²)	2 dark azure
701-2005H ¹	702-2005H ¹	705-2005H	710-2005H	703-2005H ¹	552005-341550HK ¹	552005-352010HK ¹	dark azure
Price gr. A361 (m ²)	Price gr. A280 (m ²)	Price gr. A211 (m ²)	Price gr. A157 (m ²)	Price gr. A187 (m ²)	Price gr. A259 (m ²)	Price gr. A313 (m ²)	2 active blue
701-2006H ¹	702-2006H ¹	705-2006H	710-2006H	703-2006H ¹	552006-341550HK ¹	552006-352010HK ¹	active blue
Price gr. A361 (m ²)	Price gr. A211 (m ²)	Price gr. A211 (m ²)	Price gr. A157 (m ²)	Price gr. A187 (m ²)	Price gr. A259 (m ²)	Price gr. A313 (m ²)	4 light blue
701-2007H ¹	702-2007H ¹	705-2007H	710-2007H	703-2007H ¹	552007-341550HK ¹	552007-352010HK ¹	light blue
Price gr. A361 (m ²)	Price gr. A280 (m ²)	Price gr. A211 (m ²)	Price gr. A157 (m ²)	Price gr. A187 (m ²)	Price gr. A259 (m ²)	Price gr. A313 (m ²)	3 medium blue
701-2008H ¹	702-2008H	705-2008H	710-2008H	703-2008H ¹	552008-341550HK ¹	552008-352010HK ¹	medium blue
Price gr. A361 (m ²)	Price gr. A250 (m ²)	Price gr. A211 (m ²)	Price gr. A157 (m ²)	Price gr. A187 (m ²)	Price gr. A259 (m ²)	Price gr. A313 (m ²)	2 dark blue
701-2009H ¹	702-2009H ¹	705-2009H	710-2009H	703-2009H ¹	552009-341550HK ¹	552009-352010HK ¹	dark blue
Price gr. A361 (m ²)	Price gr. A280 (m ²)	Price gr. A211 (m ²)	Price gr. A157 (m ²)	Price gr. A187 (m ²)	Price gr. A259 (m ²)	Price gr. A313 (m ²)	2 active turquoise
701-2010H ¹	702-2010H ¹	705-2010H	710-2010H	703-2010H ¹	552010-341550HK ¹	552010-352010HK ¹	active turquoise
Price gr. A361 (m ²)	Price gr. A280 (m ²)	Price gr. A211 (m ²)	Price gr. A157 (m ²)	Price gr. A187 (m ²)	Price gr. A259 (m ²)	Price gr. A313 (m ²)	4 light turquoise
701-2011H ¹	702-2011H ¹	705-2011H	710-2011H	703-2011H ¹	552011-341550HK ¹	552011-352010HK ¹	light turquoise
Price gr. A361 (m ²)	Price gr. A280 (m ²)	Price gr. A211 (m ²)	Price gr. A157 (m ²)	Price gr. A187 (m ²)	Price gr. A259 (m ²)	Price gr. A313 (m ²)	3 medium turquoise
701-2012H ¹	702-2012H ¹	705-2012H	710-2012H	703-2012H ⁴	552012-341550HK ^{1/4}	552012-352010HK ^{1/4}	medium turquoise
Price gr. A361 (m ²)	Price gr. A280 (m ²)	Price gr. A211 (m ²)	Price gr. A157 (m ²)	Price gr. A187 (m ²)	Price gr. A259 (m ²)	Price gr. A313 (m ²)	2 dark turquoise
701-2013H ¹	702-2013H ¹	705-2013H	710-2013H	703-2013H ¹	552013-341550HK ¹	552013-352010HK ¹	dark turquoise
Price gr. A361 (m ²)	Price gr. A280 (m ²)	Price gr. A211 (m ²)	Price gr. A157 (m ²)	Price gr. A187 (m ²)	Price gr. A259 (m ²)	Price gr. A313 (m ²)	2 active green
701-2014H ¹	702-2014H ¹	705-2014H	710-2014H	703-2014H ¹	552014-341550HK ¹	552014-352010HK ¹	active green
Price gr. A361 (m ²)	Price gr. A280 (m ²)	Price gr. A211 (m ²)	Price gr. A157 (m ²)	Price gr. A187 (m ²)	Price gr. A259 (m ²)	Price gr. A313 (m ²)	4 light green
701-2015H ¹	702-2015H ¹	705-2015H	710-2015H	703-2015H ¹	552015-341550HK ¹	552015-352010HK ¹	light green
Price gr. A361 (m ²)	Price gr. A280 (m ²)	Price gr. A211 (m ²)	Price gr. A157 (m ²)	Price gr. A187 (m ²)	Price gr. A259 (m ²)	Price gr. A313 (m ²)	3 medium green
701-2016H ¹	702-2016H ¹	705-2016H	710-2016H	703-2016H ¹	552016-341550HK ¹	552016-352010HK ¹	medium green
Price gr. A361 (m ²)	Price gr. A280 (m ²)	Price gr. A211 (m ²)	Price gr. A157 (m ²)	Price gr. A187 (m ²)	Price gr. A259 (m ²)	Price gr. A313 (m ²)	2 dark green

¹ Make-to-order production: return and/or cancellation of ordered products not possible.

² Upon request, defined color nuances and mosaic pictures can also be supplied.

³ Overglazed edges proportionately in the sheet.

⁴ Production-related color deviations from the standard are possible.

⁵ rectified

⁶ Exception: neutral 10 (glossy), smooth, glossy

⁸ Not suitable for operating theatres

Shower tub system, refer to series Plural non-slip, page 269/271

Floor/Wall Tiles

15 x 15 cm



20 x 20 cm

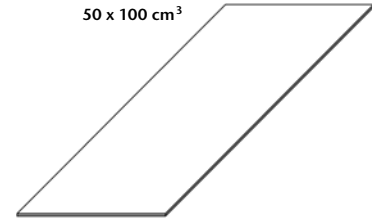

20 x 40 cm

25 x 50 cm³30 x 30 cm³30 x 60 cm³50 x 100 cm³

Model number	15 x 15 cm	20 x 20 cm	20 x 40 cm	25 x 50 cm ³	30 x 30 cm ³	30 x 60 cm ³	50 x 100 cm ³
Nom. dim. - cm/in	15 x 15 / 6 x 6	20 x 20 / 8 x 8	20 x 40 / 8 x 16	25 x 50 / 10 x 20	30 x 30 / 12 x 12	30 x 60 / 12 x 24	50 x 100 / 20 x 40
Work size	147 x 147 x 6.5 mm	197 x 197 x 6.5 mm	197 x 397 x 6.5 mm	247 x 497 x 8 mm	297 x 297 x 8 mm	297 x 597 x 8 mm	497 x 997 x 8 mm
Surface	smooth, for op-theat.	smooth, for op-theat.	smooth, for op-theat.	smooth, silky-matt ⁴	smooth, silky-matt ⁴	smooth, silky-matt ⁴	smooth, silky-matt ⁴
m ² - pieces	44.000	25.000	12.500	8.000	11.111	5.556	2.000
m ² - kg	13.816	13.875	14.100	17.040	17.222	17.413	18.080
Bundle - pieces	44	25	16	9	14	6	2
Bundle - m ²	1.000	1.000	1.280	1.125	1.260	1.080	1.000
Bundle - kg	13.816	13.875	18.048	19.170	21.700	18.804	18.080
Pallet - m ²	80.000	72.000	72.960	40.500	52.921	43.197	52.000
Pallet - kg	1,105.280	999.000	1,028.736	690.120	911.410	752.242	940.160
Product standard	Blb	Blb	Blb	Alb	Alb	Alb	Alb
Stress group	1 - 2	1 - 2	1 - 2	1 - 2	1 - 2	1 - 2	1 - 2
neutral 10 (active white glossy)	4			342550HK 700i-342550HK ⁵ Price gr. A157 (m ²)	730 730-2121H ⁵ Price gr. A166 (m ²)	760 760-2121H ⁵ Price gr. A166 (m ²)	352050HK 700i-352050HK ⁵ Price gr. A211 (m ²)
neutral 10 (active white)	4	715-2120H Price gr. A115 (m ²)	720-2120H Price gr. A115 (m ²)	740-2120H Price gr. A127 (m ²)	701i-342550HK Price gr. A157 (m ²)	730-2120H Price gr. A166 (m ²)	760-2120H Price gr. A166 (m ²)
neutral 9 (white grey)	4	715-2119H ¹ Price gr. A166 (m ²)	720-2119H ¹ Price gr. A173 (m ²)	740-2119H ¹ Price gr. A173 (m ²)	552119-342550HK Price gr. A181 (m ²)	730-2119H ¹ Price gr. A217 (m ²)	760-2119H ¹ Price gr. A217 (m ²)
neutral 8 (light-grey)	4	715-2118H Price gr. A115 (m ²)	720-2118H Price gr. A115 (m ²)	740-2118H Price gr. A127 (m ²)	552118-342550HK Price gr. A157 (m ²)	730-2118H Price gr. A166 (m ²)	760-2118H Price gr. A166 (m ²)
neutral 7 (pebble grey)	4	715-2117H ¹ Price gr. A166 (m ²)	720-2117H ¹ Price gr. A173 (m ²)	740-2117H ¹ Price gr. A173 (m ²)	552117-342550HK Price gr. A181 (m ²)	730-2117H ¹ Price gr. A217 (m ²)	760-2117H ¹ Price gr. A217 (m ²)
neutral 6 (pearl grey)	3	715-2116H ¹ Price gr. A166 (m ²)	720-2116H ¹ Price gr. A166 (m ²)	740-2116H ¹ Price gr. A173 (m ²)	552116-342550HK Price gr. A181 (m ²)	730-2116H ¹ Price gr. A217 (m ²)	760-2116H ¹ Price gr. A217 (m ²)
neutral 5 (basalt grey)	3	715-2115H ¹ Price gr. A166 (m ²)	720-2115H ¹ Price gr. A166 (m ²)	740-2115H ¹ Price gr. A173 (m ²)	552115-342550HK Price gr. A181 (m ²)	730-2115H ¹ Price gr. A217 (m ²)	760-2115H ¹ Price gr. A217 (m ²)
neutral 4 (graphite black)	3	715-2114H Price gr. A142 (m ²)	720-2114H Price gr. A142 (m ²)	740-2114H ¹ Price gr. A173 (m ²)	552114-342550HK ² Price gr. A181 (m ²)	730-2114H ^{1/2} Price gr. A217 (m ²)	760-2114H ^{1/2} Price gr. A217 (m ²)
neutral 3 (asphalt black)	3	715-2113H ¹ Price gr. A166 (m ²)	720-2113H ¹ Price gr. A166 (m ²)	740-2113H ¹ Price gr. A173 (m ²)	552113-342550HK Price gr. A181 (m ²)	730-2113H Price gr. A187 (m ²)	760-2113H Price gr. A187 (m ²)
neutral 2 (anthracite)	2	715-2112H Price gr. A142 (m ²)	720-2112H Price gr. A142 (m ²)	740-2112H ¹ Price gr. A173 (m ²)	552112-342550HK Price gr. A181 (m ²)	730-2112H ¹ Price gr. A217 (m ²)	760-2112H Price gr. A187 (m ²)
neutral 1 (deep black)	1	715-2111H Price gr. A142 (m ²)	720-2111H Price gr. A142 (m ²)	740-2111H Price gr. A151 (m ²)	5716-342550HK ² Price gr. A181 (m ²)	730-2111H ² Price gr. A217 (m ²)	760-2111H ² Price gr. A217 (m ²)
active azure	2	715-2001H ¹ Price gr. A166 (m ²)	720-2001H ¹ Price gr. A173 (m ²)	740-2001H ¹ Price gr. A173 (m ²)	552001-342550HK Price gr. A181 (m ²)	730-2001H Price gr. A187 (m ²)	760-2001H Price gr. A187 (m ²)
light azure	4	715-2002H ¹ Price gr. A166 (m ²)	720-2002H ¹ Price gr. A166 (m ²)	740-2002H ¹ Price gr. A173 (m ²)	552002-342550HK Price gr. A181 (m ²)	730-2002H ¹ Price gr. A217 (m ²)	760-2002H ¹ Price gr. A217 (m ²)
medium azure	3	715-2003H Price gr. A142 (m ²)	720-2003H Price gr. A142 (m ²)	740-2003H Price gr. A151 (m ²)	552003-342550HK Price gr. A181 (m ²)	730-2003H Price gr. A187 (m ²)	760-2003H Price gr. A187 (m ²)
dark azure	2	715-2004H ¹ Price gr. A166 (m ²)	720-2004H ¹ Price gr. A142 (m ²)	740-2004H ¹ Price gr. A173 (m ²)	552004-342550HK Price gr. A181 (m ²)	730-2004H ¹ Price gr. A217 (m ²)	760-2004H ¹ Price gr. A217 (m ²)
active blue	2	715-2005H ¹ Price gr. A166 (m ²)	720-2005H ¹ Price gr. A166 (m ²)	740-2005H ¹ Price gr. A173 (m ²)	552005-342550HK Price gr. A181 (m ²)	730-2005H ¹ Price gr. A217 (m ²)	760-2005H ¹ Price gr. A217 (m ²)
light blue	4	715-2006H ¹ Price gr. A166 (m ²)	720-2006H ¹ Price gr. A166 (m ²)	740-2006H ¹ Price gr. A173 (m ²)	552006-342550HK Price gr. A181 (m ²)	730-2006H ¹ Price gr. A217 (m ²)	760-2006H ¹ Price gr. A217 (m ²)
medium blue	3	715-2007H Price gr. A142 (m ²)	720-2007H Price gr. A142 (m ²)	740-2007H Price gr. A151 (m ²)	552007-342550HK Price gr. A181 (m ²)	730-2007H ¹ Price gr. A217 (m ²)	760-2007H ¹ Price gr. A217 (m ²)
dark blue	2	715-2008H ¹ Price gr. A166 (m ²)	720-2008H ¹ Price gr. A142 (m ²)	740-2008H ¹ Price gr. A173 (m ²)	552008-342550HK Price gr. A181 (m ²)	730-2008H ¹ Price gr. A217 (m ²)	760-2008H ¹ Price gr. A217 (m ²)
active turquoise	2	715-2009H ¹ Price gr. A166 (m ²)	720-2009H ¹ Price gr. A166 (m ²)	740-2009H ¹ Price gr. A173 (m ²)	552009-342550HK Price gr. A181 (m ²)	730-2009H ¹ Price gr. A217 (m ²)	760-2009H ¹ Price gr. A217 (m ²)
light turquoise	4	715-2010H Price gr. A142 (m ²)	720-2010H Price gr. A142 (m ²)	740-2010H Price gr. A151 (m ²)	552010-342550HK Price gr. A181 (m ²)	730-2010H ¹ Price gr. A217 (m ²)	760-2010H ¹ Price gr. A217 (m ²)
medium turquoise	3	715-2011H ¹ Price gr. A166 (m ²)	720-2011H ¹ Price gr. A166 (m ²)	740-2011H ¹ Price gr. A173 (m ²)	552011-342550HK Price gr. A181 (m ²)	730-2011H ¹ Price gr. A217 (m ²)	760-2011H ¹ Price gr. A217 (m ²)
dark turquoise	2	715-2012H ¹ Price gr. A166 (m ²)	720-2012H ¹ Price gr. A166 (m ²)	740-2012H ¹ Price gr. A173 (m ²)	552012-342550HK ² Price gr. A181 (m ²)	730-2012H ^{1/2} Price gr. A217 (m ²)	760-2012H ^{1/2} Price gr. A217 (m ²)
active green	2	715-2013H ¹ Price gr. A166 (m ²)	720-2013H ¹ Price gr. A166 (m ²)	740-2013H ¹ Price gr. A173 (m ²)	552013-342550HK Price gr. A181 (m ²)	730-2013H ¹ Price gr. A217 (m ²)	760-2013H ¹ Price gr. A217 (m ²)
light green	4	715-2014H Price gr. A142 (m ²)	720-2014H Price gr. A142 (m ²)	740-2014H Price gr. A151 (m ²)	552014-342550HK Price gr. A181 (m ²)	730-2014H ¹ Price gr. A217 (m ²)	760-2014H ¹ Price gr. A217 (m ²)
medium green	3	715-2015H ¹ Price gr. A166 (m ²)	720-2015H ¹ Price gr. A166 (m ²)	740-2015H ¹ Price gr. A173 (m ²)	552015-342550HK Price gr. A181 (m ²)	730-2015H ¹ Price gr. A217 (m ²)	760-2015H ¹ Price gr. A217 (m ²)
dark green	2	715-2016H ¹ Price gr. A166 (m ²)	720-2016H ¹ Price gr. A166 (m ²)	740-2016H ¹ Price gr. A173 (m ²)	552016-342550HK Price gr. A181 (m ²)	730-2016H ¹ Price gr. A217 (m ²)	760-2016H ¹ Price gr. A217 (m ²)



¹ Make-to-order production: return and/or cancellation of ordered products not possible

² Production-related color deviations from the standard are possible.



³ rectified

⁴ Exception: neutral 10 (glossy), smooth, glossy

⁵ Not suitable for operating theatres
All products: Color Shade Variation V0

Mosaic

1 x 1 cm^{2/6}

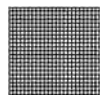

Mosaic, glued thermoplastically on back
Sheet: 313 x 313 mm

2.5 x 2.5 cm^{2/6}

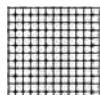

Mosaic, glued thermoplastically on back
Sheet: 297 x 297 mm

5 x 5 cm^{2/6}

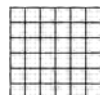

Mosaic, glued thermoplastically on back
Sheet: 297 x 297 mm

10 x 10 cm^{2/3/6}



Mosaic, glued thermoplastically on back
Sheet: 297 x 297 mm

Floor/Wall Tiles

10 x 30 cm



12.5 x 50 cm⁵



12.5 x 100 cm⁵



1 x 1 / 3/8 x 3/8 12 x 12 x 6.5 mm smooth, for op-theat. 10.000 sheets 11.930 10 sheets 1.000 11.930 24.000 286.320 Blb 1 - 2	2.5 x 2.5 / 1 x 1 23 x 23 x 6.5 mm smooth, for op-theat. 11 sheets 12.100 11 sheets 1.000 12.100 48.000 580.800 Blb 1 - 2	5 x 5 / 2 x 2 47 x 47 x 6.5 mm smooth, for op-theat. 11 sheets 12.331 11 sheets 1.000 12.331 64.000 789.184 Blb 1 - 2	10 x 10 / 4 x 4 97 x 97 x 6.5 mm smooth, for op-theat. 11 sheets 13.101 11 sheets 1.000 13.101 64.000 838.464 Blb 1 - 2	703 10 x 30 / 4 x 12 97 x 297 x 6 mm smooth, silky-matt 33.333 12.333 38 1.140 14.060 95.761 1,181.040 Alb 1 - 2	341550HK 12.5 x 50 / 5 x 20 122 x 497 x 8 mm smooth, silky-matt 16.000 17.040 8 0.500 8.520 55.000 937.200 Alb 1 - 2	352010HK 12.5 x 100 / 5 x 40 122 x 997 x 8 mm smooth, silky-matt 8.000 17.040 10 1.250 21.300 67.500 1,150.200 Alb 1 - 2	Model number Nom. dim. - cm/in Work size Surface m ² - pieces m ² - kg Bundle - pieces Bundle - m ² Bundle - kg Pallet - m ² Pallet - kg Product standard Stress group
701-2017H ¹ Price gr. A361 (m ²)	702-2017H ¹ Price gr. A280 (m ²)	705-2017H Price gr. A211 (m ²)	710-2017H Price gr. A157 (m ²)	703-2017H ^{1/4} Price gr. A187 (m ²)	552017-341550HK ^{1/4} Price gr. A259 (m ²)	552017-352010HK ^{1/4} Price gr. A313 (m ²)	2
701-2018H ¹ Price gr. A361 (m ²)	702-2018H ¹ Price gr. A280 (m ²)	705-2018H Price gr. A211 (m ²)	710-2018H Price gr. A157 (m ²)	703-2018H ¹ Price gr. A187 (m ²)	552018-341550HK ¹ Price gr. A259 (m ²)	552018-352010HK ¹ Price gr. A313 (m ²)	4
701-2019H ¹ Price gr. A361 (m ²)	702-2019H ¹ Price gr. A280 (m ²)	705-2019H Price gr. A211 (m ²)	710-2019H Price gr. A157 (m ²)	703-2019H ¹ Price gr. A187 (m ²)	552019-341550HK ¹ Price gr. A259 (m ²)	552019-352010HK ¹ Price gr. A313 (m ²)	3
701-2020H ¹ Price gr. A361 (m ²)	702-2020H ¹ Price gr. A280 (m ²)	705-2020H Price gr. A211 (m ²)	710-2020H Price gr. A157 (m ²)	703-2020H ^{1/4} Price gr. A187 (m ²)	552020-341550HK ^{1/4} Price gr. A259 (m ²)	552020-352010HK ^{1/4} Price gr. A313 (m ²)	2
701-2021H ¹ Price gr. A361 (m ²)	702-2021H ¹ Price gr. A280 (m ²)	705-2021H Price gr. A211 (m ²)	710-2021H Price gr. A157 (m ²)	703-2021H ^{1/4} Price gr. A187 (m ²)	552021-341550HK ^{1/4} Price gr. A259 (m ²)	552021-352010HK ^{1/4} Price gr. A313 (m ²)	2
701-2022H ¹ Price gr. A361 (m ²)	702-2022H ¹ Price gr. A280 (m ²)	705-2022H Price gr. A211 (m ²)	710-2022H Price gr. A157 (m ²)	703-2022H ¹ Price gr. A187 (m ²)	552022-341550HK ¹ Price gr. A259 (m ²)	552022-352010HK ¹ Price gr. A313 (m ²)	4
701-2023H ¹ Price gr. A361 (m ²)	702-2023H ¹ Price gr. A280 (m ²)	705-2023H Price gr. A211 (m ²)	710-2023H Price gr. A157 (m ²)	703-2023H ¹ Price gr. A187 (m ²)	552023-341550HK ¹ Price gr. A259 (m ²)	552023-352010HK ¹ Price gr. A313 (m ²)	3
701-2024H ¹ Price gr. A361 (m ²)	702-2024H ¹ Price gr. A280 (m ²)	705-2024H Price gr. A211 (m ²)	710-2024H Price gr. A157 (m ²)	703-2024H ¹ Price gr. A187 (m ²)	552024-341550HK ¹ Price gr. A259 (m ²)	552024-352010HK ¹ Price gr. A313 (m ²)	2
701-2025H ¹ Price gr. A361 (m ²)	702-2025H ¹ Price gr. A280 (m ²)	705-2025H Price gr. A211 (m ²)	710-2025H Price gr. A157 (m ²)	703-2025H ^{1/4} Price gr. A187 (m ²)	552025-341550HK ^{1/4} Price gr. A259 (m ²)	552025-352010HK ^{1/4} Price gr. A313 (m ²)	2
701-2026H ¹ Price gr. A361 (m ²)	702-2026H ¹ Price gr. A280 (m ²)	705-2026H Price gr. A211 (m ²)	710-2026H Price gr. A157 (m ²)	703-2026H ¹ Price gr. A187 (m ²)	552026-341550HK ¹ Price gr. A259 (m ²)	552026-352010HK ¹ Price gr. A313 (m ²)	4
701-2027H ¹ Price gr. A361 (m ²)	702-2027H ¹ Price gr. A280 (m ²)	705-2027H Price gr. A211 (m ²)	710-2027H Price gr. A157 (m ²)	703-2027H ¹ Price gr. A187 (m ²)	552027-341550HK ¹ Price gr. A259 (m ²)	552027-352010HK ¹ Price gr. A313 (m ²)	3
701-2028H ¹ Price gr. A361 (m ²)	702-2028H ¹ Price gr. A280 (m ²)	705-2028H Price gr. A211 (m ²)	710-2028H Price gr. A157 (m ²)	703-2028H ¹ Price gr. A187 (m ²)	552028-341550HK ¹ Price gr. A259 (m ²)	552028-352010HK ¹ Price gr. A313 (m ²)	2
701-2029H ¹ Price gr. A361 (m ²)	702-2029H ¹ Price gr. A280 (m ²)	705-2029H Price gr. A211 (m ²)	710-2029H Price gr. A157 (m ²)	703-2029H ¹ Price gr. A187 (m ²)	552029-341550HK ¹ Price gr. A259 (m ²)	552029-352010HK ¹ Price gr. A313 (m ²)	2
701-2030H ¹ Price gr. A361 (m ²)	702-2030H ¹ Price gr. A280 (m ²)	705-2030H Price gr. A211 (m ²)	710-2030H Price gr. A157 (m ²)	703-2030H ¹ Price gr. A187 (m ²)	552030-341550HK ¹ Price gr. A259 (m ²)	552030-352010HK ¹ Price gr. A313 (m ²)	4
701-2031H ¹ Price gr. A361 (m ²)	702-2031H ¹ Price gr. A280 (m ²)	705-2031H Price gr. A211 (m ²)	710-2031H Price gr. A157 (m ²)	703-2031H ¹ Price gr. A187 (m ²)	552031-341550HK ¹ Price gr. A259 (m ²)	552031-352010HK ¹ Price gr. A313 (m ²)	3
701-2032H ¹ Price gr. A361 (m ²)	702-2032H ¹ Price gr. A280 (m ²)	705-2032H Price gr. A211 (m ²)	710-2032H Price gr. A157 (m ²)	703-2032H ¹ Price gr. A187 (m ²)	552032-341550HK ¹ Price gr. A259 (m ²)	552032-352010HK ¹ Price gr. A313 (m ²)	2
701-2033H ¹ Price gr. A361 (m ²)	702-2033H ¹ Price gr. A280 (m ²)	705-2033H Price gr. A211 (m ²)	710-2033H Price gr. A157 (m ²)	703-2033H ¹ Price gr. A187 (m ²)	552033-341550HK ¹ Price gr. A259 (m ²)	552033-352010HK ¹ Price gr. A313 (m ²)	2
701-2034H ¹ Price gr. A361 (m ²)	702-2034H ¹ Price gr. A280 (m ²)	705-2034H Price gr. A211 (m ²)	710-2034H Price gr. A157 (m ²)	703-2034H ¹ Price gr. A187 (m ²)	552034-341550HK ¹ Price gr. A259 (m ²)	552034-352010HK ¹ Price gr. A313 (m ²)	4
701-2035H ¹ Price gr. A361 (m ²)	702-2035H ¹ Price gr. A280 (m ²)	705-2035H Price gr. A211 (m ²)	710-2035H Price gr. A157 (m ²)	703-2035H Price gr. A157 (m ²)	552035-341550HK Price gr. A229 (m ²)	552035-352010HK Price gr. A289 (m ²)	3
701-2036H ¹ Price gr. A361 (m ²)	702-2036H ¹ Price gr. A280 (m ²)	705-2036H Price gr. A211 (m ²)	710-2036H Price gr. A157 (m ²)	703-2036H ¹ Price gr. A187 (m ²)	552036-341550HK ¹ Price gr. A259 (m ²)	552036-352010HK ¹ Price gr. A313 (m ²)	2
701-2037H ¹ Price gr. A361 (m ²)	702-2037H ¹ Price gr. A280 (m ²)	705-2037H Price gr. A211 (m ²)	710-2037H Price gr. A157 (m ²)	703-2037H ¹ Price gr. A187 (m ²)	552037-341550HK ¹ Price gr. A259 (m ²)	552037-352010HK ¹ Price gr. A313 (m ²)	2
701-2038H ¹ Price gr. A361 (m ²)	702-2038H ¹ Price gr. A280 (m ²)	705-2038H Price gr. A211 (m ²)	710-2038H Price gr. A157 (m ²)	703-2038H ¹ Price gr. A187 (m ²)	552038-341550HK ¹ Price gr. A259 (m ²)	552038-352010HK ¹ Price gr. A313 (m ²)	4
701-2039H ¹ Price gr. A361 (m ²)	702-2039H ¹ Price gr. A280 (m ²)	705-2039H Price gr. A211 (m ²)	710-2039H Price gr. A157 (m ²)	703-2039H Price gr. A157 (m ²)	552039-341550HK Price gr. A229 (m ²)	552039-352010HK Price gr. A289 (m ²)	3
701-2040H ¹ Price gr. A361 (m ²)	702-2040H ¹ Price gr. A280 (m ²)	705-2040H Price gr. A211 (m ²)	710-2040H Price gr. A157 (m ²)	703-2040H ¹ Price gr. A187 (m ²)	552040-341550HK ¹ Price gr. A259 (m ²)	552040-352010HK ¹ Price gr. A313 (m ²)	2

¹ Make-to-order production: return and/or cancellation of ordered products not possible.

² Upon request, defined color nuances and mosaic pictures can also be supplied.

³ Overglazed edges proportionately in the sheet.



⁴ Production-related color deviations from the standard are possible.

⁵ rectified



Shower tub system, refer to series Plural non-slip, page 269/271

Floor/Wall Tiles

15 x 15 cm



20 x 20 cm



20 x 40 cm



25 x 50 cm³



30 x 30 cm³



30 x 60 cm³



50 x 100 cm³

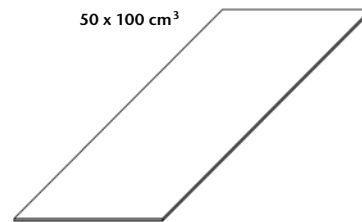

Model number	15 x 15 cm	20 x 20 cm	20 x 40 cm	25 x 50 cm ³	30 x 30 cm ³	30 x 60 cm ³	50 x 100 cm ³
Nom. dim. - cm/in	15 x 15 / 6 x 6	20 x 20 / 8 x 8	20 x 40 / 8 x 16	25 x 50 / 10 x 20	30 x 30 / 12 x 12	30 x 60 / 12 x 24	50 x 100 / 20 x 40
Work size	147 x 147 x 6.5 mm	197 x 197 x 6.5 mm	197 x 397 x 6.5 mm	247 x 497 x 8 mm	297 x 297 x 8 mm	297 x 597 x 8 mm	497 x 997 x 8 mm
Surface	smooth, for op-theat.	smooth, for op-theat.	smooth, for op-theat.	smooth, silky-matt	smooth, silky-matt	smooth, silky-matt	smooth, silky-matt
m ² - pieces	44.000	25.000	12.500	8.000	11.111	5.556	2.000
m ² - kg	13.816	13.875	14.100	17.040	17.222	17.413	18.080
Bundle - pieces	44	25	16	9	14	6	2
Bundle - m ²	1.000	1.000	1.280	1.125	1.260	1.080	1.000
Bundle - kg	13.816	13.875	18.048	19.170	21.700	18.804	18.080
Pallet - m ²	80.000	72.000	72.960	40.500	52.921	43.197	52.000
Pallet - kg	1,105.280	999.000	1,028.736	690.120	911.410	752.242	940.160
Product standard	Blb	Blb	Blb	Alb	Alb	Alb	Alb
Stress group	1 - 2	1 - 2	1 - 2	1 - 2	1 - 2	1 - 2	1 - 2
active yellow	2 715-2017H ¹ Price gr. A166 (m ²)	720-2017H Price gr. A142 (m ²)	740-2017H ¹ Price gr. A173 (m ²)	552017-342550HK ² Price gr. A181 (m ²)	730-2017H ^{1/2} Price gr. A217 (m ²)	760-2017H ^{1/2} Price gr. A217 (m ²)	552017-352050HK ^{1/2} Price gr. A259 (m ²)
light yellow	4 715-2018H Price gr. A142 (m ²)	720-2018H Price gr. A142 (m ²)	740-2018H Price gr. A151 (m ²)	552018-342550HK Price gr. A181 (m ²)	730-2018H ¹ Price gr. A217 (m ²)	760-2018H ¹ Price gr. A217 (m ²)	552018-352050HK ¹ Price gr. A259 (m ²)
medium yellow	3 715-2019H ¹ Price gr. A166 (m ²)	720-2019H ¹ Price gr. A166 (m ²)	740-2019H ¹ Price gr. A173 (m ²)	552019-342550HK Price gr. A181 (m ²)	730-2019H ¹ Price gr. A217 (m ²)	760-2019H ¹ Price gr. A217 (m ²)	552019-352050HK ¹ Price gr. A259 (m ²)
dark yellow	2 715-2020H ¹ Price gr. A166 (m ²)	720-2020H ¹ Price gr. A166 (m ²)	740-2020H ¹ Price gr. A173 (m ²)	552020-342550HK ² Price gr. A181 (m ²)	730-2020H ^{1/2} Price gr. A217 (m ²)	760-2020H ^{1/2} Price gr. A217 (m ²)	552020-352050HK ^{1/2} Price gr. A259 (m ²)
active ochre	2 715-2021H ¹ Price gr. A166 (m ²)	720-2021H ¹ Price gr. A166 (m ²)	740-2021H ¹ Price gr. A173 (m ²)	552021-342550HK ² Price gr. A181 (m ²)	730-2021H ^{1/2} Price gr. A217 (m ²)	760-2021H ^{1/2} Price gr. A217 (m ²)	552021-352050HK ^{1/2} Price gr. A259 (m ²)
light ochre	4 715-2022H Price gr. A142 (m ²)	720-2022H Price gr. A142 (m ²)	740-2022H Price gr. A151 (m ²)	552022-342550HK Price gr. A181 (m ²)	730-2022H ¹ Price gr. A217 (m ²)	760-2022H ¹ Price gr. A217 (m ²)	552022-352050HK ¹ Price gr. A259 (m ²)
medium ochre	3 715-2023H ¹ Price gr. A166 (m ²)	720-2023H ¹ Price gr. A166 (m ²)	740-2023H ¹ Price gr. A173 (m ²)	552023-342550HK Price gr. A181 (m ²)	730-2023H ¹ Price gr. A217 (m ²)	760-2023H ¹ Price gr. A217 (m ²)	552023-352050HK ¹ Price gr. A259 (m ²)
dark ochre	2 715-2024H ¹ Price gr. A166 (m ²)	720-2024H ¹ Price gr. A166 (m ²)	740-2024H ¹ Price gr. A173 (m ²)	552024-342550HK Price gr. A181 (m ²)	730-2024H ¹ Price gr. A217 (m ²)	760-2024H ¹ Price gr. A217 (m ²)	552024-352050HK ¹ Price gr. A259 (m ²)
active salmon	2 715-2025H ¹ Price gr. A166 (m ²)	720-2025H ¹ Price gr. A166 (m ²)	740-2025H ¹ Price gr. A173 (m ²)	552025-342550HK ² Price gr. A181 (m ²)	730-2025H ^{1/2} Price gr. A217 (m ²)	760-2025H ^{1/2} Price gr. A217 (m ²)	552025-352050HK ^{1/2} Price gr. A259 (m ²)
light salmon	4 715-2026H Price gr. A142 (m ²)	720-2026H ¹ Price gr. A166 (m ²)	740-2026H ¹ Price gr. A173 (m ²)	552026-342550HK Price gr. A181 (m ²)	730-2026H ¹ Price gr. A217 (m ²)	760-2026H ¹ Price gr. A217 (m ²)	552026-352050HK ¹ Price gr. A259 (m ²)
medium salmon	3 715-2027H Price gr. A142 (m ²)	720-2027H Price gr. A142 (m ²)	740-2027H Price gr. A151 (m ²)	552027-342550HK Price gr. A181 (m ²)	730-2027H ¹ Price gr. A217 (m ²)	760-2027H ¹ Price gr. A217 (m ²)	552027-352050HK ¹ Price gr. A259 (m ²)
dark salmon	2 715-2028H ¹ Price gr. A166 (m ²)	720-2028H ¹ Price gr. A166 (m ²)	740-2028H ¹ Price gr. A173 (m ²)	552028-342550HK Price gr. A181 (m ²)	730-2028H ¹ Price gr. A217 (m ²)	760-2028H ¹ Price gr. A217 (m ²)	552028-352050HK ¹ Price gr. A259 (m ²)
active oxide red	2 715-2029H ¹ Price gr. A166 (m ²)	720-2029H ¹ Price gr. A166 (m ²)	740-2029H ¹ Price gr. A173 (m ²)	552029-342550HK Price gr. A181 (m ²)	730-2029H ¹ Price gr. A217 (m ²)	760-2029H ¹ Price gr. A217 (m ²)	552029-352050HK ¹ Price gr. A259 (m ²)
light oxide red	4 715-2030H ¹ Price gr. A166 (m ²)	720-2030H ¹ Price gr. A166 (m ²)	740-2030H ¹ Price gr. A173 (m ²)	552030-342550HK Price gr. A181 (m ²)	730-2030H ¹ Price gr. A217 (m ²)	760-2030H ¹ Price gr. A217 (m ²)	552030-352050HK ¹ Price gr. A259 (m ²)
medium oxide red	3 715-2031H Price gr. A142 (m ²)	720-2031H Price gr. A142 (m ²)	740-2031H Price gr. A151 (m ²)	552031-342550HK Price gr. A181 (m ²)	730-2031H ¹ Price gr. A217 (m ²)	760-2031H ¹ Price gr. A217 (m ²)	552031-352050HK ¹ Price gr. A259 (m ²)
dark oxide red	2 715-2032H ¹ Price gr. A166 (m ²)	720-2032H ¹ Price gr. A166 (m ²)	740-2032H ¹ Price gr. A173 (m ²)	552032-342550HK Price gr. A181 (m ²)	730-2032H ¹ Price gr. A217 (m ²)	760-2032H ¹ Price gr. A217 (m ²)	552032-352050HK ¹ Price gr. A259 (m ²)
active stone grey	2 715-2033H ¹ Price gr. A166 (m ²)	720-2033H ¹ Price gr. A166 (m ²)	740-2033H ¹ Price gr. A173 (m ²)	552033-342550HK Price gr. A181 (m ²)	730-2033H ¹ Price gr. A217 (m ²)	760-2033H ¹ Price gr. A217 (m ²)	552033-352050HK ¹ Price gr. A259 (m ²)
light stone grey	4 715-2034H ¹ Price gr. A166 (m ²)	720-2034H ¹ Price gr. A166 (m ²)	740-2034H ¹ Price gr. A173 (m ²)	552034-342550HK Price gr. A181 (m ²)	730-2034H ¹ Price gr. A217 (m ²)	760-2034H ¹ Price gr. A217 (m ²)	552034-352050HK ¹ Price gr. A259 (m ²)
medium stone grey	3 715-2035H ¹ Price gr. A166 (m ²)	720-2035H ¹ Price gr. A166 (m ²)	740-2035H ¹ Price gr. A173 (m ²)	552035-342550HK Price gr. A181 (m ²)	730-2035H Price gr. A187 (m ²)	760-2035H Price gr. A187 (m ²)	552035-352050HK Price gr. A229 (m ²)
dark stone grey	2 715-2036H Price gr. A142 (m ²)	720-2036H Price gr. A142 (m ²)	740-2036H Price gr. A151 (m ²)	552036-342550HK Price gr. A181 (m ²)	730-2036H ¹ Price gr. A217 (m ²)	760-2036H ¹ Price gr. A217 (m ²)	552036-352050HK ¹ Price gr. A259 (m ²)
active sand-grey	2 715-2037H ¹ Price gr. A166 (m ²)	720-2037H ¹ Price gr. A166 (m ²)	740-2037H ¹ Price gr. A173 (m ²)	552037-342550HK Price gr. A181 (m ²)	730-2037H ¹ Price gr. A217 (m ²)	760-2037H ¹ Price gr. A217 (m ²)	552037-352050HK ¹ Price gr. A259 (m ²)
light sand-grey	4 715-2038H Price gr. A142 (m ²)	720-2038H Price gr. A142 (m ²)	740-2038H Price gr. A151 (m ²)	552038-342550HK Price gr. A181 (m ²)	730-2038H ¹ Price gr. A217 (m ²)	760-2038H ¹ Price gr. A217 (m ²)	552038-352050HK ¹ Price gr. A259 (m ²)
medium sand-grey	3 715-2039H Price gr. A142 (m ²)	720-2039H Price gr. A142 (m ²)	740-2039H Price gr. A151 (m ²)	552039-342550HK Price gr. A181 (m ²)	730-2039H Price gr. A187 (m ²)	760-2039H Price gr. A187 (m ²)	552039-352050HK Price gr. A229 (m ²)
dark sand-grey	2 715-2040H Price gr. A142 (m ²)	720-2040H Price gr. A142 (m ²)	740-2040H ¹ Price gr. A187 (m ²)	552040-342550HK Price gr. A181 (m ²)	730-2040H ¹ Price gr. A217 (m ²)	760-2040H ¹ Price gr. A217 (m ²)	552040-352050HK ¹ Price gr. A259 (m ²)



¹ Make-to-order production: return and/or cancellation of ordered products not possible

³ rectified

² Production-related color deviations from the standard are possible.

All products: Color Shade Variation V0

Mosaic

10 x 10 cm^{1/2}



Mosaic, glued
thermoplastically
on back
Sheet: 297 x 297 mm



						10 x 10 / 4 x 4		Nom. dim. - cm/in
						97 x 97 x 6.5 mm		Work size
						smooth, for op-theat.		Surface
						11 sheets		m ² - pieces
						13.101		m ² - kg
						11 sheets		Bundle - pieces
						1.000		Bundle - m ²
						13.101		Bundle - kg
						64.000		Pallet - m ²
						838.464		Pallet - kg
						Blb		Product standard
						1 - 2		Stress group
						710-2504H	3	
						Price gr. A196 (m ²)		tiefanthrazit
						710-2508H	3	
						Price gr. A196 (m ²)		deep blue
						710-2512H	3	
						Price gr. A196 (m ²)		deep green
						710-2516H	4	
						Price gr. A196 (m ²)		deep yellow
						710-2520H	4	
						Price gr. A196 (m ²)		deep orange
						710-2524H	3	
						Price gr. A196 (m ²)		deep red

¹ Overglazed edges proportionately in the sheet.

² Upon request, defined color nuances and mosaic pictures can also be supplied.



All products: Color Shade Variation V0

Cove
skirting ¹

Internal
Corner
for Cove
Skirting ¹

External
Corner
for Cove
Skirting ¹

10 x 10 cm



Nom. dim. - cm/in	10 x 10 / 4 x 4	100 x 18 x 6.5 mm	100 x 18 x 6.5 mm			
Work size	100 x 97 x 6.5 mm	100 x 18 x 6.5 mm	100 x 18 x 6.5 mm			
Surface	smooth, silky-matt	smooth, silky-matt	smooth, silky-matt			
m - pieces	10.000					
m/pce. - kg	1.500/m	0.030/pieces	0.030/pieces			
Bundle - pieces	40	40	30			
Bundle - m	4.000					
Bundle - kg	6.000					
Pallet - m						
Pallet - kg						
Product standard	B1b	B1b	B1b			
neutral 10 (active white)	4 763-2120H Price gr. A416 (pce.)	759-2120H Price gr. A430 (pce.)	761-2120H Price gr. A430 (pce.)			
neutral 9 (white grey)	4	759-2119H Price gr. A430 (pce.)	761-2119H Price gr. A430 (pce.)			
neutral 8 (light-grey)	4 763-2118H Price gr. A416 (pce.)	759-2118H Price gr. A430 (pce.)	761-2118H Price gr. A430 (pce.)			
neutral 7 (pebble grey)	4	759-2117H Price gr. A430 (pce.)	761-2117H Price gr. A430 (pce.)			
neutral 5 (basalt grey)	3 763-2115H Price gr. A416 (pce.)	759-2115H Price gr. A430 (pce.)	761-2115H Price gr. A430 (pce.)			
neutral 3 (asphalt black)	3	759-2113H Price gr. A430 (pce.)	761-2113H Price gr. A430 (pce.)			
neutral 1 (deep black)	1 763-2111H Price gr. A416 (pce.)	759-2111H Price gr. A430 (pce.)	761-2111H Price gr. A430 (pce.)			
active azure	2	759-2001H Price gr. A430 (pce.)	761-2001H Price gr. A430 (pce.)			
light azure	4	759-2002H Price gr. A430 (pce.)	761-2002H Price gr. A430 (pce.)			
medium azure	3 763-2003H Price gr. A416 (pce.)	759-2003H Price gr. A430 (pce.)	761-2003H Price gr. A430 (pce.)			
dark azure	2	759-2004H Price gr. A430 (pce.)	761-2004H Price gr. A430 (pce.)			
light blue	4	759-2006H Price gr. A430 (pce.)	761-2006H Price gr. A430 (pce.)			
medium blue	3	759-2007H Price gr. A430 (pce.)	761-2007H Price gr. A430 (pce.)			
dark blue	2	759-2008H Price gr. A430 (pce.)	761-2008H Price gr. A430 (pce.)			
medium turquoise	3	759-2011H Price gr. A430 (pce.)	761-2011H Price gr. A430 (pce.)			
medium green	3	759-2015H Price gr. A430 (pce.)	761-2015H Price gr. A430 (pce.)			
dark green	2	759-2016H Price gr. A430 (pce.)	761-2016H Price gr. A430 (pce.)			
medium yellow	3	759-2019H Price gr. A430 (pce.)	761-2019H Price gr. A430 (pce.)			
medium ochre	3	759-2023H Price gr. A430 (pce.)	761-2023H Price gr. A430 (pce.)			
medium salmon	3	759-2027H Price gr. A430 (pce.)	761-2027H Price gr. A430 (pce.)			
medium oxide red	3	759-2031H Price gr. A430 (pce.)	761-2031H Price gr. A430 (pce.)			
light stone grey	4 763-2034H Price gr. A416 (pce.)	759-2034H Price gr. A430 (pce.)	761-2034H Price gr. A430 (pce.)			
dark stone grey	2 763-2036H Price gr. A416 (pce.)	759-2036H Price gr. A430 (pce.)	761-2036H Price gr. A430 (pce.)			
active sand-grey	2 763-2037H Price gr. A416 (pce.)	759-2037H Price gr. A430 (pce.)	761-2037H Price gr. A430 (pce.)			
dark sand-grey	2 763-2040H Price gr. A416 (pce.)	759-2040H Price gr. A430 (pce.)	761-2040H Price gr. A430 (pce.)			

¹ For details, refer to page 716



Shower tub system, refer to series Plural non-slip, page 269/271
All products: Color Shade Variation V0



Project: Explorer Hotel / Location: St. Johann, Austria / Architect: Camp Innenarchitektur / Series: Plural / Photo: Roland Reuter, Absam





Project: Gisela Schule (school) / Location: Passau, Germany / Architect: Feigel, Huber, Dumps / Series: Plural non-slip / Photo: Michael Christian Peters





				
2120/2121 neutral 10 (active white)	2004 dark azure	2003 medium azure	2002 light azure	2001 active azure
				
2119 neutral 9 (white-grey)	2008 dark blue	2007 medium blue	2006 light blue	2005 active blue
				
2118 neutral 8 (light-grey)	2012 dark turquoise	2011 medium turquoise	2010 light turquoise	2009 active turquoise
				
2117 neutral 7 (pebble-grey)	2016 dark green	2015 medium green	2014 light green	2013 active green
				
2116 neutral 6 (pearl grey)	2020 dark yellow	2019 medium yellow	2018 light yellow	2017 active yellow
				
2115 neutral 5 (basalt-grey)	2024 dark ochre	2023 medium ochre	2022 light ochre	2021 active ochre
				
2114 neutral 4 (graphite-black)	2028 dark salmon	2027 medium salmon	2026 light salmon	2025 active salmon
				
2113 neutral 3 (asphalt black)	2032 dark oxide red	2031 medium oxide red	2030 light oxide red	2029 active oxide red
				
2112 neutral 2 (anthracite)	2036 dark stone grey	2035 medium stone grey	2034 light stone grey	2033 active stone grey
				
2111 neutral 1 (deep black)	2040 dark sand grey	2039 medium sand grey	2038 light sand grey	2037 active sand grey

Mosaic 2.5 x 2.5 cm, 1 x 1 in

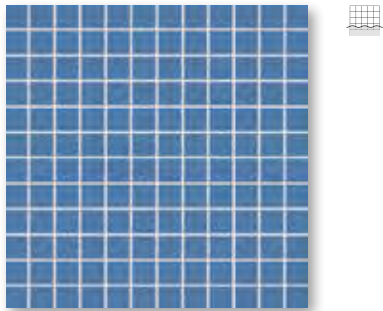

Mosaic sheet 30 x 30 cm, 12 x 12 in, smooth, R10/B

Mosaic 5 x 5 cm, 2 x 2 in

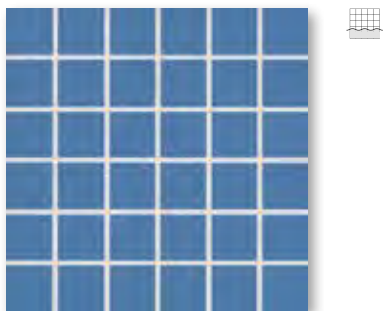

Mosaic sheet 30 x 30 cm, 12 x 12 in, smooth, R10/B

Mosaic 10 x 10 cm, 4 x 4 in

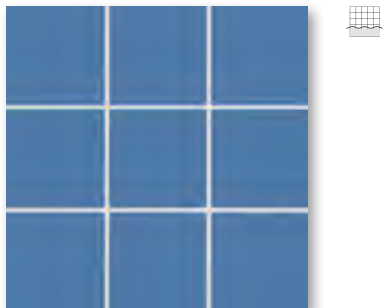

Mosaic sheet 30 x 30 cm, 12 x 12 in, smooth, R10/B



Cove skirting
10 x 10 cm, 4 x 4 in
smooth, R10/B



Shower tub system Corner
10 x 10 cm, 4 x 4 in
smooth, R10/B



Internal
corner
smooth



External
corner
smooth



Shower tub system Strip,
10 x 10 cm, 4 x 4 in
smooth, R10/B

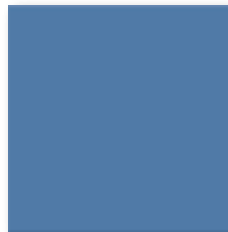

Floor tile 20 x 20 cm, 8 x 8 in
smooth, R10/B



Floor tile 30 x 60 cm, 12 x 24 in
smooth, R10/B

Do you already know our Mosaic Designer at our website
www.agrob-buchtal.de?

There, you will have the possibility of designing your individual
color gradients, mosaic compositions and the laying of pictures.

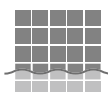

Mosaics glued thermoplastically on back of AGROB BUCHTAL can be used
not only in dry zones but also without any problems in underwater areas
(e.g. swimming pools/whirlpools) as well as in permanently wet areas
(e.g. pool surrounds/showers).

Mosaic^{2/4}

Wall/Floor Tiles

2.5 x 2.5 cm

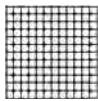

5 x 5 cm

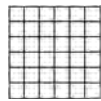

10 x 10 cm

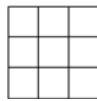

20 x 20 cm



30 x 60 cm^{1/3} **NEW**



Mosaic, glued thermoplastically on back
Sheet: 297 x 297 mm

Mosaic, glued thermoplastically on back
Sheet: 297 x 297 mm

Mosaic, glued thermoplastically on back
Sheet: 297 x 297 mm

Nom. dim. - cm/in	2.5 x 2.5 / 1 x 1	5 x 5 / 2 x 2	10 x 10 / 4 x 4	20 x 20 / 8 x 8	30 x 60 / 12 x 24
Work size	23 x 23 x 6.5 mm	47 x 47 x 6.5 mm	97 x 97 x 6.5 mm	197 x 197 x 6.5 mm	297 x 597 x 8 mm
Surface	smooth, matt	smooth, matt	smooth, matt	smooth, matt	smooth, matt
m ² - pieces	11 sheets	11 sheets	11 sheets	25.000	5.556
m ² - kg	12.100	12.331	13.101	13.875	17.413
Bundle - pieces	11 sheets	11 sheets	11 sheets	25	6
Bundle - m ²	1.000	1.000	1.000	1.000	1.080
Bundle - kg	12.100	12.331	13.101	13.875	18.804
Pallet - m ²	48.000	64.000	64.000	72.000	43.197
Pallet - kg	580.800	789.184	838.464	999.000	752.242
Product standard	Blb	Blb	Blb	Blb	Alb
Slip resistance	R10/B	R10/B	R10/B	R10/B	R10/B
Stress group	1 - 2	1 - 2	1 - 2	1 - 2	1 - 2
neutral 10 (active white)	4 902-2120H Price gr. A238 (m ²)	905-2120H Price gr. A205 (m ²)	910-2120H Price gr. A166 (m ²)	920-2120H Price gr. A148 (m ²)	980-2120H Price gr. A181 (m ²)
neutral 9 (white grey)	4 902-2119H¹ Price gr. A289 (m ²)	905-2119H¹ Price gr. A250 (m ²)	910-2119H Price gr. A190 (m ²)	920-2119H¹ Price gr. A190 (m ²)	
neutral 8 (light-grey)	4 902-2118H Price gr. A238 (m ²)	905-2118H Price gr. A205 (m ²)	910-2118H Price gr. A166 (m ²)	920-2118H Price gr. A148 (m ²)	980-2118H Price gr. A205 (m ²)
neutral 7 (pebble grey)	4 902-2117H¹ Price gr. A289 (m ²)	905-2117H¹ Price gr. A256 (m ²)	910-2117H Price gr. A190 (m ²)	920-2117H¹ Price gr. A190 (m ²)	
neutral 6 (pearl grey)	3 902-2116H¹ Price gr. A289 (m ²)	905-2116H¹ Price gr. A256 (m ²)	910-2116H¹ Price gr. A223 (m ²)	920-2116H¹ Price gr. A190 (m ²)	
neutral 5 (basalt grey)	3 902-2115H¹ Price gr. A289 (m ²)	905-2115H¹ Price gr. A256 (m ²)	910-2115H Price gr. A190 (m ²)	920-2115H Price gr. A166 (m ²)	
neutral 4 (graphite black)	3 902-2114H¹ Price gr. A289 (m ²)	905-2114H¹ Price gr. A256 (m ²)	910-2114H Price gr. A190 (m ²)	920-2114H Price gr. A166 (m ²)	
neutral 3 (asphalt black)	3 902-2113H¹ Price gr. A289 (m ²)	905-2113H¹ Price gr. A256 (m ²)	910-2113H Price gr. A190 (m ²)	920-2113H¹ Price gr. A190 (m ²)	
neutral 2 (anthracite)	2 902-2112H¹ Price gr. A289 (m ²)	905-2112H¹ Price gr. A256 (m ²)	910-2112H Price gr. A190 (m ²)	920-2112H Price gr. A166 (m ²)	
neutral 1 (deep black)	1 902-2111H Price gr. A259 (m ²)	905-2111H Price gr. A229 (m ²)	910-2111H Price gr. A190 (m ²)	920-2111H Price gr. A166 (m ²)	980-2111H Price gr. A181 (m ²)
active azure	2 902-2001H¹ Price gr. A289 (m ²)	905-2001H¹ Price gr. A256 (m ²)	910-2001H Price gr. A190 (m ²)	920-2001H¹ Price gr. A190 (m ²)	
light azure	4 902-2002H¹ Price gr. A289 (m ²)	905-2002H¹ Price gr. A256 (m ²)	910-2002H Price gr. A190 (m ²)	920-2002H¹ Price gr. A190 (m ²)	
medium azure	3 902-2003H Price gr. A259 (m ²)	905-2003H Price gr. A229 (m ²)	910-2003H Price gr. A190 (m ²)	920-2003H Price gr. A166 (m ²)	980-2003H Price gr. A205 (m ²)
dark azure	2 902-2004H Price gr. A259 (m ²)	905-2004H¹ Price gr. A256 (m ²)	910-2004H Price gr. A190 (m ²)	920-2004H Price gr. A166 (m ²)	
active blue	2 902-2005H¹ Price gr. A289 (m ²)	905-2005H¹ Price gr. A256 (m ²)	910-2005H¹ Price gr. A223 (m ²)	920-2005H¹ Price gr. A190 (m ²)	
light blue	4 902-2006H¹ Price gr. A289 (m ²)	905-2006H¹ Price gr. A256 (m ²)	910-2006H Price gr. A190 (m ²)	920-2006H¹ Price gr. A190 (m ²)	
medium blue	3 902-2007H¹ Price gr. A289 (m ²)	905-2007H¹ Price gr. A256 (m ²)	910-2007H Price gr. A190 (m ²)	920-2007H Price gr. A166 (m ²)	980-2007H Price gr. A205 (m ²)
dark blue	2 902-2008H Price gr. A259 (m ²)	905-2008H Price gr. A229 (m ²)	910-2008H Price gr. A190 (m ²)	920-2008H Price gr. A166 (m ²)	
active turquoise	2 902-2009H¹ Price gr. A289 (m ²)	905-2009H¹ Price gr. A256 (m ²)	910-2009H¹ Price gr. A223 (m ²)	920-2009H¹ Price gr. A190 (m ²)	
light turquoise	4 902-2010H¹ Price gr. A289 (m ²)	905-2010H¹ Price gr. A256 (m ²)	910-2010H¹ Price gr. A223 (m ²)	920-2010H¹ Price gr. A190 (m ²)	
medium turquoise	3 902-2011H¹ Price gr. A289 (m ²)	905-2011H¹ Price gr. A256 (m ²)	910-2011H Price gr. A190 (m ²)	920-2011H Price gr. A166 (m ²)	980-2011H Price gr. A205 (m ²)
dark turquoise	2 902-2012H¹ Price gr. A289 (m ²)	905-2012H¹ Price gr. A256 (m ²)	910-2012H¹ Price gr. A223 (m ²)	920-2012H¹ Price gr. A190 (m ²)	
active green	2 902-2013H¹ Price gr. A289 (m ²)	905-2013H¹ Price gr. A256 (m ²)	910-2013H¹ Price gr. A223 (m ²)	920-2013H¹ Price gr. A190 (m ²)	
light green	4 902-2014H¹ Price gr. A289 (m ²)	905-2014H Price gr. A229 (m ²)	910-2014H¹ Price gr. A223 (m ²)	920-2014H¹ Price gr. A190 (m ²)	
medium green	3 902-2015H¹ Price gr. A289 (m ²)	905-2015H¹ Price gr. A256 (m ²)	910-2015H Price gr. A190 (m ²)	920-2015H Price gr. A166 (m ²)	980-2015H Price gr. A205 (m ²)
dark green	2 902-2016H¹ Price gr. A289 (m ²)	905-2016H¹ Price gr. A256 (m ²)	910-2016H Price gr. A190 (m ²)	920-2016H Price gr. A166 (m ²)	



¹ **Make-to-order production: return and/or cancellation of ordered products not possible.**

All products: Color Shade Variation V0



² **rectified**



⁴ **Upon request, defined color nuances and mosaic pictures can also be supplied.**

Cove skirting¹ Internal
Corner
for Cove
Skirting¹

External
Corner
for Cove
Skirting¹

Shower Tub System¹

10 x 10 cm



10 x 10 cm



10 x 10 cm



					Strip		Corner		Stress group	Nom. dim. - cm/in
		10 x 10 / 4 x 4	100 x 18 x 6.5 mm	100 x 18 x 6.5 mm	10 x 10 / 4 x 4	10 x 10 / 4 x 4	10 x 10 / 4 x 4	10 x 10 / 4 x 4		
		100 x 97 x 6.5 mm	smooth, matt	10.000	1.500/m	40	4.000	6.000		Work size
		Bib	Bib	Bib	Bib	Bib	Bib	Bib		m - pieces
		R10/B	R10/B	R10/B	R10/B	R10/B	R10/B	R10/B		m/pce. - kg
		764-2120H	759-2120H	761-2120H	785-2120H	786-2120H			4	Bundle - pieces
		Price gr. A418 (pce.)	Price gr. A430 (pce.)	Price gr. A430 (pce.)	Price gr. A428 (pce.)	Price gr. A455 (pce.)				Bundle - m
		764-2119H	759-2119H	761-2119H	785-2119H	786-2119H			4	Bundle - kg
		Price gr. A418 (pce.)	Price gr. A430 (pce.)	Price gr. A430 (pce.)	Price gr. A428 (pce.)	Price gr. A455 (pce.)				Pallet - m
		764-2118H	759-2118H	761-2118H	785-2118H	786-2118H			4	Pallet - kg
		Price gr. A418 (pce.)	Price gr. A430 (pce.)	Price gr. A430 (pce.)	Price gr. A428 (pce.)	Price gr. A455 (pce.)				Product standard
		764-2117H	759-2117H	761-2117H	785-2117H	786-2117H			4	Slip resistance
		Price gr. A418 (pce.)	Price gr. A430 (pce.)	Price gr. A430 (pce.)	Price gr. A428 (pce.)	Price gr. A455 (pce.)				neutral 10
										(active white)
		764-2115H	759-2115H	761-2115H	785-2115H	786-2115H			3	neutral 9
		Price gr. A418 (pce.)	Price gr. A430 (pce.)	Price gr. A430 (pce.)	Price gr. A428 (pce.)	Price gr. A455 (pce.)				(white grey)
		764-2113H	759-2113H	761-2113H	785-2113H	786-2113H			3	neutral 8
		Price gr. A418 (pce.)	Price gr. A430 (pce.)	Price gr. A430 (pce.)	Price gr. A428 (pce.)	Price gr. A455 (pce.)				(light-grey)
		764-2111H	759-2111H	761-2111H	785-2111H	786-2111H			1	neutral 7
		Price gr. A418 (pce.)	Price gr. A430 (pce.)	Price gr. A430 (pce.)	Price gr. A428 (pce.)	Price gr. A455 (pce.)				(pebble grey)
		764-2001H	759-2001H	761-2001H	785-2001H	786-2001H			2	neutral 5
		Price gr. A418 (pce.)	Price gr. A430 (pce.)	Price gr. A430 (pce.)	Price gr. A428 (pce.)	Price gr. A455 (pce.)				(basalt grey)
		764-2002H	759-2002H	761-2002H	785-2002H	786-2002H			4	neutral 3
		Price gr. A418 (pce.)	Price gr. A430 (pce.)	Price gr. A430 (pce.)	Price gr. A428 (pce.)	Price gr. A455 (pce.)				(asphalt black)
		764-2003H	759-2003H	761-2003H	785-2003H	786-2003H			3	neutral 1
		Price gr. A418 (pce.)	Price gr. A430 (pce.)	Price gr. A430 (pce.)	Price gr. A428 (pce.)	Price gr. A455 (pce.)				(deep black)
		764-2004H	759-2004H	761-2004H	785-2004H	786-2004H			2	active azure
		Price gr. A418 (pce.)	Price gr. A430 (pce.)	Price gr. A430 (pce.)	Price gr. A428 (pce.)	Price gr. A455 (pce.)				
		764-2006H	759-2006H	761-2006H	785-2006H	786-2006H			4	light azure
		Price gr. A418 (pce.)	Price gr. A430 (pce.)	Price gr. A430 (pce.)	Price gr. A428 (pce.)	Price gr. A455 (pce.)				
		764-2007H	759-2007H	761-2007H	785-2007H	786-2007H			3	medium azure
		Price gr. A418 (pce.)	Price gr. A430 (pce.)	Price gr. A430 (pce.)	Price gr. A428 (pce.)	Price gr. A455 (pce.)				
		764-2008H	759-2008H	761-2008H	785-2008H	786-2008H			2	dark azure
		Price gr. A418 (pce.)	Price gr. A430 (pce.)	Price gr. A430 (pce.)	Price gr. A428 (pce.)	Price gr. A455 (pce.)				
		764-2011H	759-2011H	761-2011H	785-2011H	786-2011H			3	light blue
		Price gr. A418 (pce.)	Price gr. A430 (pce.)	Price gr. A430 (pce.)	Price gr. A428 (pce.)	Price gr. A455 (pce.)				
		764-2015H	759-2015H	761-2015H	785-2015H	786-2015H			3	medium blue
		Price gr. A418 (pce.)	Price gr. A430 (pce.)	Price gr. A430 (pce.)	Price gr. A428 (pce.)	Price gr. A455 (pce.)				
		764-2016H	759-2016H	761-2016H	785-2016H	786-2016H			2	dark blue
		Price gr. A418 (pce.)	Price gr. A430 (pce.)	Price gr. A430 (pce.)	Price gr. A428 (pce.)	Price gr. A455 (pce.)				

¹ For details, refer to page 716

All products: Color Shade Variation V0



Mosaic^{2/4}

Wall/Floor Tiles

2.5 x 2.5 cm

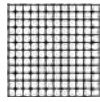

5 x 5 cm

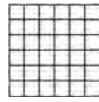

10 x 10 cm

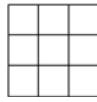

20 x 20 cm



30 x 60 cm^{1/3} **NEW**



Mosaic, glued thermoplastically on back
Sheet: 297 x 297 mm

Mosaic, glued thermoplastically on back
Sheet: 297 x 297 mm

Mosaic, glued thermoplastically on back
Sheet: 297 x 297 mm

Nom. dim. - cm/in	2.5 x 2.5 / 1 x 1	5 x 5 / 2 x 2	10 x 10 / 4 x 4	20 x 20 / 8 x 8	30 x 60 / 12 x 24
Work size	23 x 23 x 6.5 mm	47 x 47 x 6.5 mm	97 x 97 x 6.5 mm	197 x 197 x 6.5 mm	297 x 597 x 8 mm
Surface	smooth, matt	smooth, matt	smooth, matt	smooth, matt	smooth, matt
m ² - pieces	11 sheets	11 sheets	11 sheets	25.000	5.556
m ² - kg	12.100	12.331	13.101	13.875	17.413
Bundle - pieces	11 sheets	11 sheets	11 sheets	25	6
Bundle - m ²	1.000	1.000	1.000	1.000	1.080
Bundle - kg	12.100	12.331	13.101	13.875	18.804
Pallet - m ²	48.000	64.000	64.000	72.000	43.197
Pallet - kg	580.800	789.184	838.464	999.000	752.242
Product standard	B1b	B1b	B1b	B1b	Alb
Slip resistance	R10/B	R10/B	R10/B	R10/B	R10/B
Stress group	1 - 2	1 - 2	1 - 2	1 - 2	1 - 2
active yellow	2 902-2017H ¹ Price gr. A289 (m ²)	905-2017H ¹ Price gr. A256 (m ²)	910-2017H ¹ Price gr. A223 (m ²)	920-2017H ¹ Price gr. A190 (m ²)	
light yellow	4 902-2018H ¹ Price gr. A289 (m ²)	905-2018H ¹ Price gr. A256 (m ²)	910-2018H ¹ Price gr. A223 (m ²)	920-2018H ¹ Price gr. A190 (m ²)	
medium yellow	3 902-2019H ¹ Price gr. A289 (m ²)	905-2019H ¹ Price gr. A256 (m ²)	910-2019H ¹ Price gr. A190 (m ²)	920-2019H ¹ Price gr. A166 (m ²)	980-2019H Price gr. A205 (m ²)
dark yellow	2 902-2020H ¹ Price gr. A289 (m ²)	905-2020H ¹ Price gr. A256 (m ²)	910-2020H ¹ Price gr. A223 (m ²)	920-2020H ¹ Price gr. A190 (m ²)	
active ochre	2 902-2021H ¹ Price gr. A289 (m ²)	905-2021H ¹ Price gr. A256 (m ²)	910-2021H ¹ Price gr. A223 (m ²)	920-2021H ¹ Price gr. A190 (m ²)	
light ochre	4 902-2022H ¹ Price gr. A289 (m ²)	905-2022H ¹ Price gr. A256 (m ²)	910-2022H ¹ Price gr. A190 (m ²)	920-2022H ¹ Price gr. A190 (m ²)	
medium ochre	3 902-2023H ¹ Price gr. A289 (m ²)	905-2023H ¹ Price gr. A256 (m ²)	910-2023H ¹ Price gr. A190 (m ²)	920-2023H ¹ Price gr. A166 (m ²)	980-2023H Price gr. A205 (m ²)
dark ochre	2 902-2024H ¹ Price gr. A289 (m ²)	905-2024H ¹ Price gr. A256 (m ²)	910-2024H ¹ Price gr. A223 (m ²)	920-2024H ¹ Price gr. A190 (m ²)	
active salmon	2 902-2025H ¹ Price gr. A289 (m ²)	905-2025H ¹ Price gr. A256 (m ²)	910-2025H ¹ Price gr. A223 (m ²)	920-2025H ¹ Price gr. A190 (m ²)	
light salmon	4 902-2026H ¹ Price gr. A289 (m ²)	905-2026H ¹ Price gr. A256 (m ²)	910-2026H ¹ Price gr. A223 (m ²)	920-2026H ¹ Price gr. A190 (m ²)	
medium salmon	3 902-2027H ¹ Price gr. A289 (m ²)	905-2027H ¹ Price gr. A229 (m ²)	910-2027H ¹ Price gr. A190 (m ²)	920-2027H ¹ Price gr. A166 (m ²)	980-2027H Price gr. A205 (m ²)
dark salmon	2 902-2028H ¹ Price gr. A289 (m ²)	905-2028H ¹ Price gr. A256 (m ²)	910-2028H ¹ Price gr. A223 (m ²)	920-2028H ¹ Price gr. A166 (m ²)	
active oxide red	2 902-2029H ¹ Price gr. A289 (m ²)	905-2029H ¹ Price gr. A229 (m ²)	910-2029H ¹ Price gr. A223 (m ²)	920-2029H ¹ Price gr. A190 (m ²)	
light oxide red	4 902-2030H ¹ Price gr. A289 (m ²)	905-2030H ¹ Price gr. A256 (m ²)	910-2030H ¹ Price gr. A223 (m ²)	920-2030H ¹ Price gr. A190 (m ²)	
medium oxide red	3 902-2031H ¹ Price gr. A289 (m ²)	905-2031H ¹ Price gr. A256 (m ²)	910-2031H ¹ Price gr. A190 (m ²)	920-2031H ¹ Price gr. A166 (m ²)	980-2031H Price gr. A205 (m ²)
dark oxide red	2 902-2032H ¹ Price gr. A289 (m ²)	905-2032H ¹ Price gr. A256 (m ²)	910-2032H ¹ Price gr. A223 (m ²)	920-2032H ¹ Price gr. A190 (m ²)	
active stone grey	2 902-2033H ¹ Price gr. A289 (m ²)	905-2033H ¹ Price gr. A256 (m ²)	910-2033H ¹ Price gr. A190 (m ²)	920-2033H ¹ Price gr. A190 (m ²)	
light stone grey	4 902-2034H ¹ Price gr. A289 (m ²)	905-2034H ¹ Price gr. A256 (m ²)	910-2034H ¹ Price gr. A190 (m ²)	920-2034H ¹ Price gr. A190 (m ²)	
medium stone grey	3 902-2035H ¹ Price gr. A289 (m ²)	905-2035H ¹ Price gr. A256 (m ²)	910-2035H ¹ Price gr. A190 (m ²)	920-2035H ¹ Price gr. A190 (m ²)	
dark stone grey	2 902-2036H ¹ Price gr. A259 (m ²)	905-2036H ¹ Price gr. A229 (m ²)	910-2036H ¹ Price gr. A190 (m ²)	920-2036H ¹ Price gr. A166 (m ²)	
active sand-grey	2 902-2037H ¹ Price gr. A289 (m ²)	905-2037H ¹ Price gr. A256 (m ²)	910-2037H ¹ Price gr. A190 (m ²)	920-2037H ¹ Price gr. A190 (m ²)	
light sand-grey	4 902-2038H ¹ Price gr. A289 (m ²)	905-2038H ¹ Price gr. A229 (m ²)	910-2038H ¹ Price gr. A190 (m ²)	920-2038H ¹ Price gr. A166 (m ²)	
medium sand-grey	3 902-2039H ¹ Price gr. A289 (m ²)	905-2039H ¹ Price gr. A229 (m ²)	910-2039H ¹ Price gr. A190 (m ²)	920-2039H ¹ Price gr. A166 (m ²)	980-2039H Price gr. A205 (m ²)
dark sand-grey	2 902-2040H ¹ Price gr. A259 (m ²)	905-2040H ¹ Price gr. A229 (m ²)	910-2040H ¹ Price gr. A190 (m ²)	920-2040H ¹ Price gr. A166 (m ²)	



¹ Make-to-order production: return and/or cancellation of ordered products not possible.



³ rectified

⁴ Upon request, defined color nuances and mosaic pictures can also be supplied.

All products: Color Shade Variation V0

Cove skirting¹ Internal
Corner
for Cove
Skirting¹

10 x 10 cm



External
Corner
for Cove
Skirting¹



Shower Tub System¹

10 x 10 cm



10 x 10 cm



					Strip	Corner	
	10 x 10 / 4 x 4	100 x 97 x 6.5 mm	100 x 18 x 6.5 mm	100 x 18 x 6.5 mm	10 x 10 / 4 x 4	10 x 10 / 4 x 4	Nom. dim. - cm/in
	smooth, matt	smooth, matt	smooth, matt	smooth, matt	smooth, matt	smooth, matt	Work size
	10.000				10.000		Surface
	1.500/m	0.030/pieces	0.030/pieces	1.700/m	0.170/pieces	4	m - pieces
	40	40	30	16			m/pce. - kg
	4.000			2.720	0.680		Bundle - pieces
	6.000						Bundle - m
							Bundle - kg
							Pallet - m
							Pallet - kg
	Bib	Bib	Bib	Bib	Bib	Bib	Product standard
	R10/B				R10/B	R10/B	Slip resistance
							Stress group
	764-2019H	759-2019H	761-2019H	785-2019H	786-2019H		3
	Price gr. A418 (pce.)	Price gr. A430 (pce.)	Price gr. A430 (pce.)	Price gr. A428 (pce.)	Price gr. A455 (pce.)		medium yellow
	764-2023H	759-2023H	761-2023H	785-2023H	786-2023H		3
	Price gr. A418 (pce.)	Price gr. A430 (pce.)	Price gr. A430 (pce.)	Price gr. A428 (pce.)	Price gr. A455 (pce.)		medium ochre
	764-2027H	759-2027H	761-2027H	785-2027H	786-2027H		3
	Price gr. A418 (pce.)	Price gr. A430 (pce.)	Price gr. A430 (pce.)	Price gr. A428 (pce.)	Price gr. A455 (pce.)		medium salmon
	764-2031H	759-2031H	761-2031H	785-2031H	786-2031H		3
	Price gr. A418 (pce.)	Price gr. A430 (pce.)	Price gr. A430 (pce.)	Price gr. A428 (pce.)	Price gr. A455 (pce.)		medium oxide red
	764-2034H	759-2034H	761-2034H	785-2034H	786-2034H		4
	Price gr. A418 (pce.)	Price gr. A430 (pce.)	Price gr. A430 (pce.)	Price gr. A428 (pce.)	Price gr. A455 (pce.)		light stone grey
	764-2036H	759-2036H	761-2036H	785-2036H	786-2036H		2
	Price gr. A418 (pce.)	Price gr. A430 (pce.)	Price gr. A430 (pce.)	Price gr. A428 (pce.)	Price gr. A455 (pce.)		dark stone grey
	764-2037H	759-2037H	761-2037H	785-2037H	786-2037H		2
	Price gr. A418 (pce.)	Price gr. A430 (pce.)	Price gr. A430 (pce.)	Price gr. A428 (pce.)	Price gr. A455 (pce.)		active sand-grey
	764-2040H	759-2040H	761-2040H	785-2040H	786-2040H		2
	Price gr. A418 (pce.)	Price gr. A430 (pce.)	Price gr. A430 (pce.)	Price gr. A428 (pce.)	Price gr. A455 (pce.)		dark sand-grey

¹ For details, refer to page 716

All products: Color Shade Variation V0



272 PLURAL UNGLAZED

Project: Hauswirtschaftsschule (home economics school) / Location: Sankt Gallen, Switzerland / Architect: Architekturbüro Daniel Cavelti / Series: Plural unglazed / Photo: Adriano Faragulo





274 PLURAL UNGLAZED
porcelain stoneware



R10/B R11/C



2008
dark blue



2040
dark sand grey



2016
dark green



2041
medium brown



2023
medium ochre



2042
medium grey



2033
active stone grey



2043
medium sand



2038
sandwhite



2111
neutral 1 (deep black)



2039
medium sand grey



2113
neutral 3 (asphalt black)

Mosaic 2.5 x 2.5 cm, 1 x 1 in

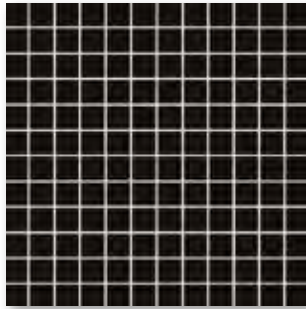

Mosaic sheet 30 x 30 cm, 12 x 12 in, smooth, R10/B

Mosaic 5 x 5 cm, 2 x 2 in



Mosaic sheet 30 x 30 cm, 12 x 12 in, smooth, R10/B

Mosaic 10 x 10 cm, 4 x 4 in

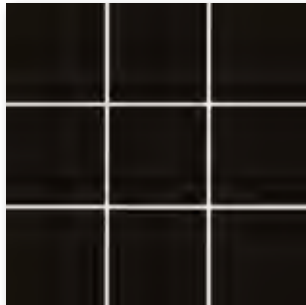

Mosaic sheet 30 x 30 cm, 12 x 12 in, smooth, R10/B
Mosaic sheet 30 x 30 cm, 12 x 12 in, relief, R11/C



Floor tile 15 x 15 cm, 6 x 6 in, smooth, R10/B
Floor tile 15 x 15 cm, 6 x 6 in, relief, R11/C



Floor tile 20 x 20 cm, 8 x 8 in, smooth, R10/B



Floor tile 30 x 60 cm, 12 x 24 in, smooth, R10/B



Cove skirting
10 x 10 cm, 4 x 4 in, smooth, R10/B



Shower tub system Corner
10 x 10 cm, 4 x 4 in, smooth, R10/B



Shower tub system Strip
10 x 10 cm, 4 x 4 in, smooth, R10/B

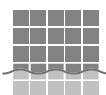

Mosaics glued thermoplastically on back of AGROB BUCHTAL can be used not only in dry zones but also without any problems in underwater areas (e.g. swimming pools/whirlpools) as well as in permanently wet areas (e.g. pool surrounds/showers).

Mosaic^{1/2}

Floor Tiles



protected

2.5 x 2.5 cm



Mosaic, glued
thermoplastically
on back
Sheet: 297 x 297 mm

5 x 5 cm



Mosaic, glued
thermoplastically
on back
Sheet: 297 x 297 mm

10 x 10 cm



Mosaic, glued
thermoplastically
on back
Sheet: 297 x 297 mm

10 x 10 cm



Mosaic, glued
thermoplastically
on back
Sheet: 297 x 297 mm

15 x 15 cm



15 x 15 cm



Nom. dim. - cm/in	2.5 x 2.5 / 1 x 1	5 x 5 / 2 x 2	10 x 10 / 4 x 4	10 x 10 / 4 x 4	15 x 15 / 6 x 6	15 x 15 / 6 x 6	
Work size	23 x 23 x 6.5 mm	47 x 47 x 6.5 mm	97 x 97 x 6.5 mm	97 x 97 x 6.5 mm	147 x 147 x 6.5 mm	147 x 147 x 6.5 mm	
Surface	smooth, matt	smooth, matt	smooth, matt	relief, matt	smooth, matt	relief, matt	
m ² - pieces	11 sheets	11 sheets	11 sheets	11 sheets	44.000	44.000	
m ² - kg	12.100	12.331	13.101	13.101	13.816	13.816	
Bundle - pieces	11 sheets	11 sheets	11 sheets	11 sheets	44	44	
Bundle - m ²	1.000	1.000	1.000	1.000	1.000	1.000	
Bundle - kg	12.100	12.331	13.101	13.101	13.816	13.816	
Pallet - m ²	48.000	64.000	64.000	64.000	80.000	80.000	
Pallet - kg	580.800	789.184	838.464	838.464	1,105.280	1,105.280	
Product standard	Bla	Bla	Bla	Bla	Bla	Bla	
Slip resistance	R10/B	R10/B	R10/B	R11/C	R10/B	R11/C	
Stress group	1 - 2	1 - 2	1 - 2	1 - 2	1 - 2	1 - 2	
neutral 3 (asphalt black)	410-2113 Price gr. A199 (m ²)	610-2113 Price gr. A175 (m ²)	810-2113 Price gr. A136 (m ²)	811-2113 Price gr. A166 (m ²)	812-2113 Price gr. A127 (m ²)	813-2113 Price gr. A148 (m ²)	
neutral 1 (deep black)	410-2111 Price gr. A199 (m ²)	610-2111 Price gr. A175 (m ²)	810-2111 Price gr. A136 (m ²)	811-2111 Price gr. A166 (m ²)	812-2111 Price gr. A127 (m ²)	813-2111 Price gr. A148 (m ²)	
dark blue	410-2008 Price gr. A238 (m ²)	610-2008 Price gr. A211 (m ²)	810-2008 Price gr. A175 (m ²)				
dark green		610-2016 Price gr. A211 (m ²)	810-2016 Price gr. A175 (m ²)				
medium ochre	410-2023 Price gr. A238 (m ²)	610-2023 Price gr. A211 (m ²)	810-2023 Price gr. A175 (m ²)				
active stone grey		610-2033 Price gr. A211 (m ²)	810-2033 Price gr. A175 (m ²)				
sand-white	410-2038 Price gr. A199 (m ²)	610-2038 Price gr. A175 (m ²)	810-2038 Price gr. A136 (m ²)	811-2038 Price gr. A166 (m ²)	812-2038 Price gr. A127 (m ²)	813-2038 Price gr. A148 (m ²)	
medium sand-grey	410-2039 Price gr. A199 (m ²)	610-2039 Price gr. A175 (m ²)	810-2039 Price gr. A136 (m ²)				
dark sand-grey	410-2040 Price gr. A199 (m ²)	610-2040 Price gr. A175 (m ²)	810-2040 Price gr. A136 (m ²)				
medium brown	410-2041 Price gr. A238 (m ²)	610-2041 Price gr. A211 (m ²)	810-2041 Price gr. A175 (m ²)				
medium grey	410-2042 Price gr. A238 (m ²)	610-2042 Price gr. A211 (m ²)	810-2042 Price gr. A175 (m ²)	811-2042 Price gr. A181 (m ²)	812-2042 Price gr. A154 (m ²)	813-2042 Price gr. A175 (m ²)	
medium sand beige	410-2043 Price gr. A238 (m ²)	610-2043 Price gr. A211 (m ²)	810-2043 Price gr. A175 (m ²)				



² Upon request, defined color nuances and mosaic pictures can also be supplied.

All products: Color Shade Variation V0

Floor Tiles

Cove skirting Shower Tub System²

20 x 20 cm



30 x 60 cm¹ **NEW**



10 x 10 cm



10 x 10 cm



10 x 10 cm



		20 x 20 / 8 x 8	30 x 60 / 12 x 24	10 x 10 / 4 x 4	Strip 10 x 10 / 4 x 4	Corner 10 x 10 / 4 x 4	
		197 x 197 x 6.5 mm	297 x 597 x 6 mm	100 x 97 x 6.5 mm	97 x 97 x 6.5 mm	97 x 97 x 6.5 mm	Nom. dim. - cm/in
		smooth, matt	smooth, matt	smooth, matt	smooth, matt	smooth, matt	Work size
		25.000/m ²	5.556/m ²	10.000/m	10.000/m	10.000/m	Surface
		13.875/m ²	13.273/m ²	1.500/m	1.700/m	0.170/pieces	m ² /m - pieces
		25	10	40	16	4	m ² /m/pce. - kg
		1.000 m ²	1.800/m ²	4.000 m	1.600 m	0.680	Bundle - pieces
		13.875	23.890	6.000	2.720		Bundle - m ² /m
		72.000	71.994				Bundle - kg
		999.000	955.600				Pallet - m ²
		Bla	Bla	Bla	Bla	Bla	Pallet - kg
		R10/B	R10/B	R10/B	R10/B	R10/B	Product standard
		1 - 2	1				Slip resistance
		815-2113	806-2113	864-2113	885-2113	886-2113	Stress group
		Price gr. A115 (m ²)	Price gr. A121 (m ²)	Price gr. A419 (pce.)	Price gr. A445 (pce.)	Price gr. A475 (pce.)	neutral 3
		815-2111	806-2111	864-2111	885-2111	886-2111	(asphalt black)
		Price gr. A115 (m ²)	Price gr. A121 (m ²)	Price gr. A419 (pce.)	Price gr. A445 (pce.)	Price gr. A475 (pce.)	neutral 1
		815-2008		864-2008	885-2008	886-2008	(deep black)
		Price gr. A148 (m ²)		Price gr. A419 (pce.)	Price gr. A445 (pce.)	Price gr. A475 (pce.)	dark blue
				864-2016			dark green
				Price gr. A419 (pce.)			dark green
		815-2023		864-2023	885-2023	886-2023	medium ochre
		Price gr. A148 (m ²)		Price gr. A419 (pce.)	Price gr. A445 (pce.)	Price gr. A475 (pce.)	medium ochre
				864-2033			active stone grey
				Price gr. A419 (pce.)			active stone grey
		815-2038	806-2038	864-2038	885-2038	886-2038	sand-white
		Price gr. A115 (m ²)	Price gr. A121 (m ²)	Price gr. A419 (pce.)	Price gr. A445 (pce.)	Price gr. A475 (pce.)	sand-white
		815-2039		864-2039	885-2039	886-2039	medium sand-grey
		Price gr. A115 (m ²)		Price gr. A419 (pce.)	Price gr. A445 (pce.)	Price gr. A475 (pce.)	medium sand-grey
		815-2040		864-2040	885-2040	886-2040	dark sand-grey
		Price gr. A115 (m ²)		Price gr. A419 (pce.)	Price gr. A445 (pce.)	Price gr. A475 (pce.)	dark sand-grey
		815-2041		864-2041	885-2041	886-2041	medium brown
		Price gr. A148 (m ²)		Price gr. A419 (pce.)	Price gr. A445 (pce.)	Price gr. A475 (pce.)	medium brown
		815-2042	806-2042	864-2042	885-2042	886-2042	medium grey
		Price gr. A148 (m ²)	Price gr. A121 (m ²)	Price gr. A419 (pce.)	Price gr. A445 (pce.)	Price gr. A475 (pce.)	medium grey
		815-2043		864-2043	885-2043	886-2043	medium sand beige
		Price gr. A148 (m ²)		Price gr. A419 (pce.)	Price gr. A445 (pce.)	Price gr. A475 (pce.)	medium sand beige



² For details, refer to page 716

All products: Color Shade Variation V0





Project: August-Köhler-Kinderhaus / Location: Gotha, Germany / Architect: Architekturbüro Dipl. Ing. Arch. Matthias Wohlleben / Series: Plural Kids / Photo: Jochen Stüber





Under the sea,
20 x 20 cm,
8 x 8 in
Set of 5 motifs



Art. no. of set: 212121

Way up high,
20 x 20 cm,
8 x 8 in
Set of 5 motifs



Art. no. of set: 212120

Moon travel,
20 x 20 cm,
8 x 8 in
Set of 5 motifs



Art. no. of set: 212122

Children of the world,
20 x 20 cm,
8 x 8 in
Set of 5 motifs



Art. no. of set: 212124

Orient Express, 20 x 20 cm, 8 x 8 in
Set of 5 motifs



Art. no. of set: 212123

Animal alphabet,
20 x 20 cm,
8 x 8 in

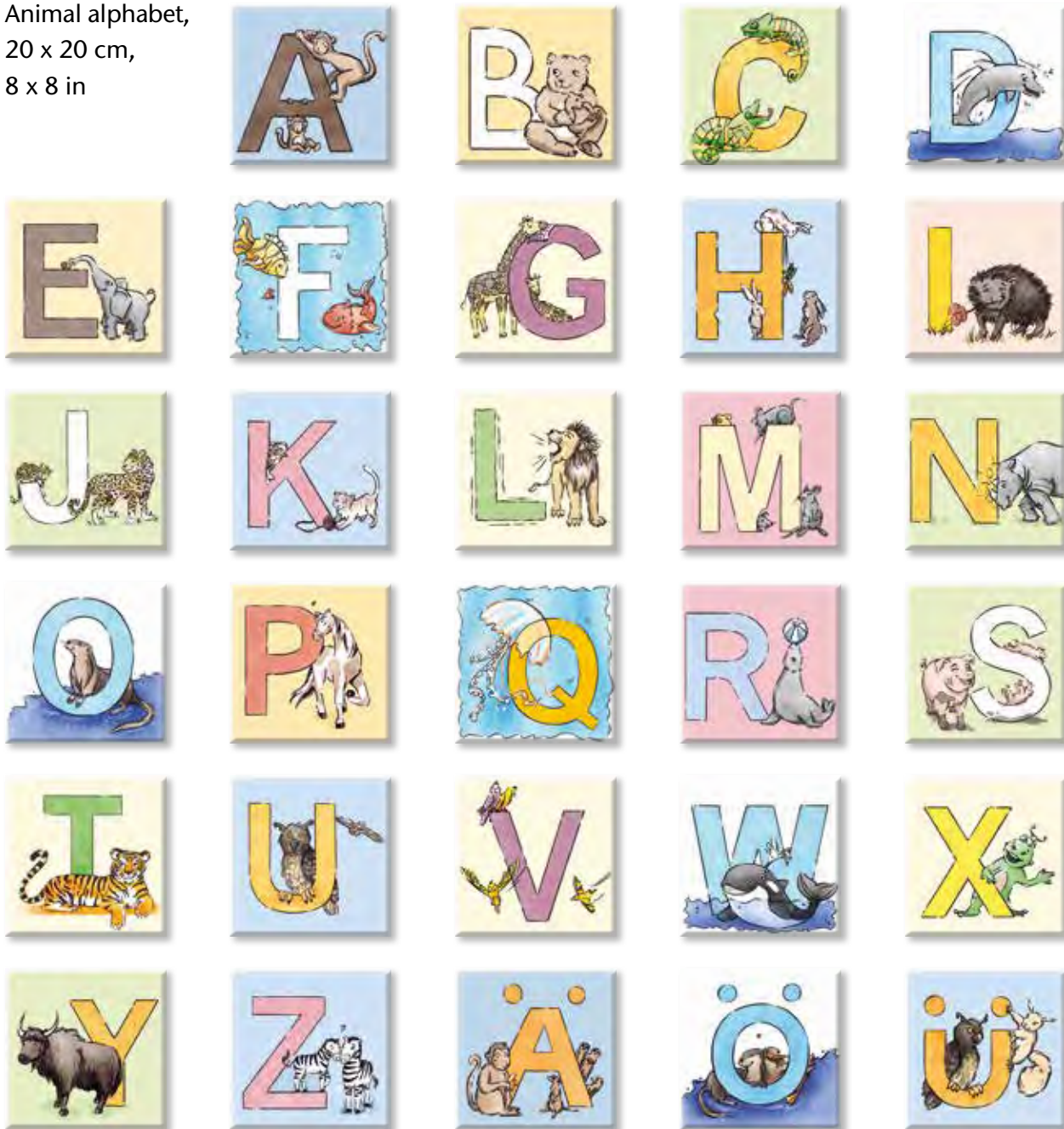

Numbers with animals,
20 x 20 cm, 8 x 8 in



Art. no.: 212142 Same article number for letters and numbers. Please give additional details when ordering.



20 x 20 cm



20 x 20 cm



Numbers + letters

Set of 5 motifs

Nom. dim. - cm/in	20 x 20 / 8 x 8	20 x 20 / 8 x 8				
Work size	197 x 197 x 6.5 mm	197 x 197 x 6.5 mm				
Surface	smooth, glossy	smooth, glossy				
m - pieces	5.000	5.000				
m - kg	2.240	2.240				
Bundle - pieces	1 VE = 5 St.	1 Set = 5 St.				
Bundle - m	0.200	2.000				
Bundle - kg	0.448	2.240				
Pallet - m						
Pallet - kg						
Product standard	BIII	BIII				
Kids		212120				
Way up high		Price gr. A539 (Set)				
Kids		212121				
Under the sea		Price gr. A539 (Set)				
Kids		212122				
Moon travel		Price gr. A539 (Set)				
Kids		212123				
Orient Express		Price gr. A539 (Set)				
Kids		212124				
Children of the world		Price gr. A539 (Set)				
Numbers + letters	212142 ¹ Price gr. A438 (pce.)					

¹ Same article number for numbers and letters.
When ordering, please specify letter or number in addition.

All products: Color Shade Variation V4



Project: August-Köhler-Kinderhaus / Location: Gotha, Germany / Architect: Architekturbüro Dipl. Ing. Arch. Matthias Wohlleben / Series: Plural Kids / Photo: Jochen Stüber





Studio photo / Architect: VSBL, Belgrade, Serbia / Series: Quarzit / Photo: Jochen Stüber





Natural and lively

Besides its natural look, Quarzit is impressive because of unusual characteristics, which are based on an innovative glazing process. The glaze, which is enriched with a granulate, is applied and durably bonded to the tile body during firing. The result is a surface vividly nuanced by discreet gloss and mica spots in an authentic stone look. In addition to the aesthetic advantages, there are also practical ones: pleasant haptics is combined with high slip resistance and enormous wear resistance.



basalt-grey



quarz-grey



sand-beige



sepia-brown



white-grey



Floor tile 12.5 x 12.5 cm, 5 x 5 in, structured, R11/B

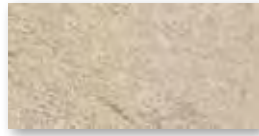

Floor tile 12.5 x 25 cm, 5 x 10 in, structured, R11/B



Grid profile tile 12.5 x 25 cm, 5 x 10 in, relief, R11/C

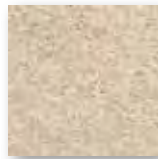

Floor tile 15 x 15 cm, 6 x 6 in, structured, R11/C



Floor tile 25 x 25 cm, 10 x 10 in, structured, R10/A,
Floor tile 25 x 25 cm, 10 x 10 in, structured, R11/B

Mosaic 5 x 5 cm, 2 x 2 in



Mosaic sheet 30 x 30 cm, 12 x 12 in, structured, R11/B



Floor tile 25 x 50 cm, 10 x 20 in, structured, R10/A
Floor tile 25 x 50 cm, 10 x 20 in, structured, R11/B



Floor tile 30 x 60 cm, 12 x 24 in, structured, R10/A
Floor tile 30 x 60 cm, 12 x 24 in, structured, R11/B

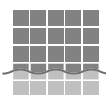

Mosaics glued thermoplastically on back of AGROB BUCHTAL can be used not only in dry zones but also without any problems in underwater areas (e.g. swimming pools/whirlpools) as well as in permanently wet areas (e.g. pool surrounds/showers).



*Floor tile 60 x 60 cm, 24 x 24 in, structured, R10/A
Patio tile 60 x 60 cm, 24 x 24 in, structured, R11/B*



Stair tile with bevel 31 x 135 cm, 12.4 x 54 in, structured, R10/A



Riser 28 x 135 cm, 11.2 x 54 in, structured



R11/B R11/C



basalt-grey

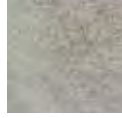

quarz-grey



sand-beige



sepia-brown



white-grey



Letter tile 25 x 50 cm, 10 x 20 in, structured, R11/B



Skirting, cut 6 x 50 cm, 2 3/8 x 20 in, structured

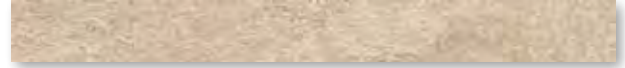

Skirting, cut 6 x 60 cm, 2 3/8 x 24 in, structured



Cove skirting, decorated 10 x 60 cm, 4 x 24 in, structured



Grooved tile 50 x 25 cm, 10 x 20 in grooved, R11/C

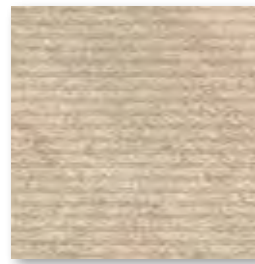

Grooved tile 25 x 25 cm, 10 x 10 in grooved, R11/C



Grooved tile 12,5 x 25 cm, 5 x 10 in grooved, R11/C



Grid profile tile 25 x 50 cm, 10 x 20 in, relief, R11/C

Gutter tile (trough depth 5 mm)



Gutter tile* 50 x 25 cm, 20 x 10 in structured, R11/B

Ceramic channel cover* 50 x 25 cm, 10 x 20 in structured



Ceramic channel cover* corner solution 30 x 30 cm, 12 x 12 in, structured



*For details, see chapter Pool + Spa; Ceramic channel cover 2.0, page 451 (make-to-order production).

without illustration: Gutter tile with outlet, mitred pair, terminal piece

Floor Tiles 3 mm joint

5 x 5 cm¹



15 x 15 cm



25 x 25 cm¹



25 x 25 cm¹



25 x 50 cm¹



25 x 50 cm¹



25 x 50 cm^{1/2}



Mosaic, glass fibre net on reverse side
Sheet: 297 x 297 mm

Grid profile tile

7161H	342030H	332050HK	332050HK	342550HK	342550HK	342580HK	Model number
5 x 5 / 2 x 2	15 x 15 / 6 x 6	25 x 25 / 10 x 10	25 x 25 / 10 x 10	25 x 50 / 10 x 20	25 x 50 / 10 x 20	25 x 50 / 10 x 20	Nom. dim. - cm/in
47 x 47 x 8 mm	147 x 147 x 8 mm	247 x 247 x 8 mm	247 x 247 x 8 mm	247 x 497 x 8 mm	247 x 497 x 8 mm	247 x 497 x 8 mm	Work size
structured, matt	structured, matt	structured, matt	structured, matt	structured, matt	structured, matt	relief, matt	Surface
11.111	44.444	16.000	16.000	8.000	8.000	8.000	m ² - pieces
16.389	17.555	16.960	16.960	17.040	17.040	17.040	m ² - kg
14	35	14	14	9	9	9	Bundle - pieces
1.260	0.788	0.875	0.875	1.125	1.125	1.125	Bundle - m ²
20.650	13.825	14.840	14.840	19.170	19.170	19.170	Bundle - kg
37.800	63.001	70.875	70.875	40.500	40.500	40.500	Pallet - m ²
619.500	1,106.000	1,202.040	1,202.040	690.120	690.120	690.120	Pallet - kg
Alb	Bl _a	Alb	Alb	Alb	Alb	Alb	Product standard
R11/B	R11/C	R10/A	R11/B	R10/A	R11/B	R11/C	Slip resistance
2	2	2	2	2	2	2	Stress group
8460-7161H	8460-342030H	8450-332050HK	8460-332050HK	8450-342550HK	8460-342550HK	8460-342580HK	basalt-grey
Price gr. A289 (m ²)	Price gr. A157 (m ²)	Price gr. A148 (m ²)	Price gr. A157 (m ²)	Price gr. A157 (m ²)	Price gr. A166 (m ²)	Price gr. A181 (m ²)	
8461-7161H	8461-342030H	8451-332050HK	8461-332050HK	8451-342550HK	8461-342550HK	8461-342580HK	quartz-grey
Price gr. A289 (m ²)	Price gr. A157 (m ²)	Price gr. A148 (m ²)	Price gr. A157 (m ²)	Price gr. A157 (m ²)	Price gr. A166 (m ²)	Price gr. A181 (m ²)	
8462-7161H	8462-342030H	8452-332050HK	8462-332050HK	8452-342550HK	8462-342550HK	8462-342580HK	sand-beige
Price gr. A289 (m ²)	Price gr. A157 (m ²)	Price gr. A148 (m ²)	Price gr. A157 (m ²)	Price gr. A157 (m ²)	Price gr. A166 (m ²)	Price gr. A181 (m ²)	
8463-7161H	8463-342030H	8453-332050HK	8463-332050HK	8453-342550HK	8463-342550HK	8463-342580HK	sepia-brown
Price gr. A289 (m ²)	Price gr. A157 (m ²)	Price gr. A148 (m ²)	Price gr. A157 (m ²)	Price gr. A157 (m ²)	Price gr. A166 (m ²)	Price gr. A181 (m ²)	
8464-7161H	8464-342030H	8454-332050HK	8464-332050HK	8454-342550HK	8464-342550HK	8464-342580HK	white-grey
Price gr. A289 (m ²)	Price gr. A157 (m ²)	Price gr. A148 (m ²)	Price gr. A157 (m ²)	Price gr. A157 (m ²)	Price gr. A166 (m ²)	Price gr. A181 (m ²)	

Floor Tiles 3 mm joint¹

30 x 60 cm



30 x 60 cm



60 x 60 cm



12.5 x 12.5 cm³



12.5 x 25 cm



12.5 x 25 cm²



Grid profile

B200HK	B200HK	B600HK	32020H	38110H	34090H	Model number
30 x 60 / 12 x 24	30 x 60 / 12 x 24	60 x 60 / 24 x 24	12.5 x 12.5 / 5 x 5	12.5 x 25 / 5 x 10	12.5 x 25 / 5 x 10	Nom. dim. - cm/in
297 x 597 x 8 mm	297 x 597 x 8 mm	597 x 597 x 8 mm	119 x 119 x 8 mm	119 x 244 x 8 mm	119 x 244 x 8 mm	Work size
structured, matt	structured, matt	structured, matt	structured, matt	structured, matt	relief, matt	Surface
5.556	5.556	2.778	64.000	32.000	32.000	m ² - pieces
17.413	17.413	18.001	15.360	15.680	15.360	m ² - kg
6	6	4	66	33	33	Bundle - pieces
1.080	1.080	1.440	1.031	1.031	1.031	Bundle - m ²
18.804	18.804	25.920	15.840	16.170	15.840	Bundle - kg
43.197	43.197	43.197	86.625	86.625	86.625	Pallet - m ²
752.160	752.160	777.600	1,330.560	1,358.200	1,330.560	Pallet - kg
Alb	Alb	Alb	Alb	Alb	Alb	Product standard
R10/A	R11/B	R10/A	R11/B	R11/B	R11/C	Slip resistance
2	2	2	2	2	2	Stress group
8450-B200HK	8460-B200HK	8450-B600HK	8460-32020H	8460-38110H	8460-34090H	basalt-grey
Price gr. A136 (m ²)	Price gr. A157 (m ²)	Price gr. A154 (m ²)	Price gr. A157 (m ²)	Price gr. A127 (m ²)	Price gr. A148 (m ²)	
8451-B200HK	8461-B200HK	8451-B600HK	8461-32020H	8461-38110H	8461-34090H	quartz-grey
Price gr. A136 (m ²)	Price gr. A157 (m ²)	Price gr. A154 (m ²)	Price gr. A157 (m ²)	Price gr. A127 (m ²)	Price gr. A148 (m ²)	
8452-B200HK	8462-B200HK	8452-B600HK	8462-32020H	8462-38110H	8462-34090H	sand-beige
Price gr. A136 (m ²)	Price gr. A157 (m ²)	Price gr. A154 (m ²)	Price gr. A157 (m ²)	Price gr. A127 (m ²)	Price gr. A148 (m ²)	
8453-B200HK	8463-B200HK	8453-B600HK	8463-32020H	8463-38110H	8463-34090H	sepia-brown
Price gr. A136 (m ²)	Price gr. A157 (m ²)	Price gr. A154 (m ²)	Price gr. A157 (m ²)	Price gr. A127 (m ²)	Price gr. A148 (m ²)	
8454-B200HK	8464-B200HK	8454-B600HK	8464-32020H	8464-38110H	8464-34090H	white-grey
Price gr. A136 (m ²)	Price gr. A157 (m ²)	Price gr. A154 (m ²)	Price gr. A157 (m ²)	Price gr. A127 (m ²)	Price gr. A148 (m ²)	

¹ rectified

All products: Color Shade Variation V4

² Make-to-order production: return and/or cancellation of ordered products not possible.

³ Supplied as double-tiles; to be broken by customer

Stair tile with Bevel^{2/3}

31 x 135 cm



Riser^{2/3}

28 x 135 cm



Skirting, cut¹

6 x 50 cm



6 x 60 cm



Cove skirting, decorated^{1/2/5}

10 x 60 cm



Letter Tile^{1/2/4}

25 x 50 cm

WT. 1.35m



Type height 7 cm

Model number	B775HK	B776HK	342557HK	B611HK	B612HK	342555HK
Nom. dim. - cm/in	31 x 135 / 12 13/64 x 53 5/32	28 x 135 / 11 x 53 5/32	6 x 50 / 2 3/8 x 20	6 x 60 / 2 3/8 x 24	10 x 60 / 4 x 24	25 x 50 / 10 x 20
Work size	307 x 1347 x 10.5 mm	280 x 1347 x 10.5 mm	60 x 497 x 8 mm	60 x 597 x 8 mm	100 x 597/35 x 9 mm	247 x 497 x 8 mm
Surface	structured, matt	structured, matt	structured, matt	structured, matt	structured, matt	structured, matt
m - pieces	0.741	0.741	2.000	1.667	1.667	2
St./m - kg	7.321/m	6.676/m	1.098/m	1.100/m	2.000/m	2.13/pieces
Bundle - pieces	2	2	30	34	20	
Bundle - m	2.699	2.699	15.000	20.396	11.998	
Bundle - kg	19.760	18.020	16.470	22.440	24.000	
Pallet - m						
Pallet - kg						
Product standard	Alb	Alb	Alb	Alb	Alb	Alb
Slip resistance	R10/A	R10/A				R11/B
Stress group	2 - 3	2 - 3				
basalt-grey	8450-B775HK Price gr. A560 (pce.)	8450-B776HK Price gr. A528 (pce.)	8450-342557HK Price gr. A434 (pce.)	8450-B611HK Price gr. A434 (pce.)	8450-B612HK Price gr. A445 (pce.)	900725-342555HK Price gr. A668 (pce.)
quartz-grey	8451-B775HK Price gr. A560 (pce.)	8451-B776HK Price gr. A528 (pce.)	8451-342557HK Price gr. A434 (pce.)	8451-B611HK Price gr. A434 (pce.)	8451-B612HK Price gr. A445 (pce.)	900726-342555HK Price gr. A668 (pce.)
sand-beige	8452-B775HK Price gr. A560 (pce.)	8452-B776HK Price gr. A528 (pce.)	8452-342557HK Price gr. A434 (pce.)	8452-B611HK Price gr. A434 (pce.)	8452-B612HK Price gr. A445 (pce.)	900713-342555HK Price gr. A668 (pce.)
sepia-brown	8453-B775HK Price gr. A560 (pce.)	8453-B776HK Price gr. A528 (pce.)	8453-342557HK Price gr. A434 (pce.)	8453-B611HK Price gr. A434 (pce.)	8453-B612HK Price gr. A445 (pce.)	900714-342555HK Price gr. A668 (pce.)
white-grey	8454-B775HK Price gr. A560 (pce.)	8454-B776HK Price gr. A528 (pce.)	8454-342557HK Price gr. A434 (pce.)	8454-B611HK Price gr. A434 (pce.)	8454-B612HK Price gr. A445 (pce.)	900719-342555HK Price gr. A668 (pce.)



¹  rectified

²  Make-to-order production: return and/or cancellation of ordered products not possible.

³ Only rectified on the two short sides. The long side can not be rectified.

⁴ Only figures/letters can be realized.

Color combination:

Base color: basalt-grey, quartz-grey, sand-beige, sepia-brown,
color of letters: active white / neutral 10.

Base color: white-grey, color of letters: deep black/neutral 1.

⁵ The cove skirting complies with DIN EN 14411, group Al_b, glazed (GL)

All products: Color Shade Variation V4

Patio Tiles^{1/4}

60 x 60 cm

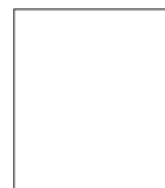

						61061HK	Model number
						60 x 60 / 24 x 24	Nom. dim. - cm/in
						597 x 597 x 20 mm	Work size mm
						structured, matt	Surface
						2.778	m ² - pieces
						43.059	m ² - kg
						1	Bundle - pieces
						0.360	Bundle - m ²
						15.500	Bundle - kg
						17.280	Pallet - m ²
						744.000	Pallet - kg
						Alla	Product standard
						R11/B	Slip resistance
						3 - 4	Stress group
						8460-61061HK	4
						Price gr. A239 (m ²)	basalt-grey
						8461-61061HK	4
						Price gr. A239 (m ²)	quartz-grey
						8462-61061HK	4
						Price gr. A239 (m ²)	sand-beige



rectified

⁴ High weight only to carry with two persons.



Gutter Tiles^{1/2}
(trough depth 5 mm)

50 x 25 cm



Gutter tile

50 x 25 cm

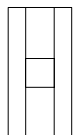

Gutter tile with outlet
110 / 110 mm

50 x 25 cm

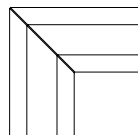

Gutter tile, mitred pair

50 x 25 cm

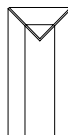

Gutter tile, terminal piece

Grooved Tiles 12.5 mm thick,
for continuing the Pool Edge System "Finland II"^{1/3}

50 x 25 cm

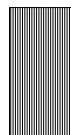

25 x 25 cm



12.5 x 25 cm



Gutter tile

Gutter tile with outlet
110 / 110 mm

Gutter tile, mitred pair

Gutter tile, terminal piece

53320	53321	53322	53323	53151	53150	53159	Model number
50 x 25 / 20 x 10	50 x 25 / 20 x 10	(2x) 487 x 244 x 14	494 x 244 x 14	50 x 25 / 20 x 10	25 x 25 / 10 x 10	12.5 x 25 / 5 x 10	Nom. dim. - cm/in
494 x 244 x 14	494 x 244 x 14	(2x) 487 x 244 x 14	494 x 244 x 14	494 x 244 x 12.5	244 x 244 x 12.5	119 x 244 x 12.5	Work size mm
structured, matt	structured, matt	structured, matt	structured, matt	grooved, matt	grooved, matt	grooved, matt	Surface
2.000	2.000	2.000	2.000	2.000	4.000	8.000	m - pieces
2.500/pieces	2.300/pieces	3.800/pair	2.500/pieces	3.550/pieces	1.775/pieces	0.888/pieces	pce./pair - kg
5 pieces	5 pieces	2 pairs	5 pieces	6 pieces	9 pieces	21 pieces	Bundle - pce./pair
2.500	2.300	7.600	12.500	3.000	2.250	2.625	Bundle - m
12.500	11.500	7.600	12.500	21.300	15.975	18.648	Bundle - kg
							Pallet - m
							Pallet - kg
Alb	Alb	Alb	Alb	Alb	Alb	Alb	Product standard
R11/B	R11/B	R11/B	R11/B	R11/C	R11/C	R11/C	Slip resistance
8460-53320	8460-53321	8460-53322	8460-53323	8460-53151	8460-53150	8460-53159	basalt-grey
Price gr. A519 (pce.)	Price gr. A593 (pce.)	Price gr. A645 (pair)	Price gr. A593 (pce.)	Price gr. A560 (pce.)	Price gr. A480 (pce.)	Price gr. A430 (pce.)	quartz-grey
8461-53320	8461-53321	8461-53322	8461-53323	8461-53151	8461-53150	8461-53159	sand-beige
Price gr. A519 (pce.)	Price gr. A593 (pce.)	Price gr. A645 (pair)	Price gr. A593 (pce.)	Price gr. A560 (pce.)	Price gr. A480 (pce.)	Price gr. A430 (pce.)	sepia-brown
8462-53320	8462-53321	8462-53322	8462-53323	8462-53151	8462-53150	8462-53159	white-grey
Price gr. A519 (pce.)	Price gr. A593 (pce.)	Price gr. A645 (pair)	Price gr. A593 (pce.)	Price gr. A560 (pce.)	Price gr. A480 (pce.)	Price gr. A430 (pce.)	
8463-53320	8463-53321	8463-53322	8463-53323	8463-53151	8463-53150	8463-53159	
Price gr. A519 (pce.)	Price gr. A593 (pce.)	Price gr. A645 (pair)	Price gr. A593 (pce.)	Price gr. A560 (pce.)	Price gr. A480 (pce.)	Price gr. A430 (pce.)	
8464-53320	8464-53321	8464-53322	8464-53323	8464-53151	8464-53150	8464-53159	
Price gr. A519 (pce.)	Price gr. A593 (pce.)	Price gr. A645 (pair)	Price gr. A593 (pce.)	Price gr. A560 (pce.)	Price gr. A480 (pce.)	Price gr. A430 (pce.)	



¹ Short edge rectified

² On request, also available in a length of 497 mm.

All products: Color Shade Variation V4

³ Make-to-order production: return and/or cancellation of ordered products not possible.





Studio photo / Architect: VSBL, Belgrade, Serbia / Series: Savona / Photo: Jochen Stüber





Elegant and timeless

Structures and colors of various rocks from the Italian coastal region of "Cinque Terre" merge in the Savona floor tile series to create a lively composition of coarse-grained texture and soft layers. A finely dosed granulate application gives the surface a pleasantly stony look and haptics. Mica-like glossy spots underline the natural effect.



R10/A R11/B R11/C

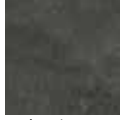
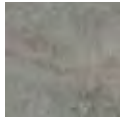
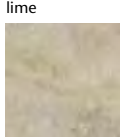

lime

beige

brown

grey

anthracite



Floor tile 15 x 15 cm, 6 x 6 in structured, R11/C



Floor tile 30 x 60 cm, 12 x 24 in, structured, R10/A
Floor tile 30 x 60 cm, 12 x 24 in, structured, R11/B



Floor tile 60 x 60 cm, 24 x 24 in, structured, R10/A
Floor tile 60 x 60 cm, 24 x 24 in, structured, R11/B



Skirting cut 6 x 60 cm, 2 3/8 x 20 in, structured

Mosaic 5 x 5 cm, 2 x 2 in

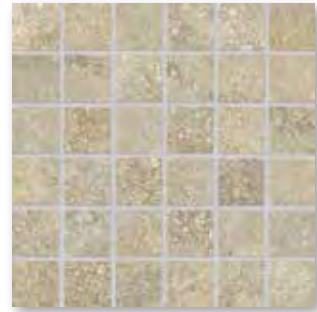

Mosaic sheet 30 x 30 cm, 12 x 12 in structured, R11/B

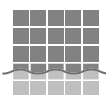

Mosaics glued thermoplastically on back of AGROB BUCHTAL can be used not only in dry zones but also without any problems in underwater areas (e.g. swimming pools/whirlpools) as well as in permanently wet areas (e.g. pool surrounds/showers).



Floor tile 60 x 120 cm, 24 x 48 in, structured, R10/A



*Washbasin SURF® large 55 x 120 cm, 22 x 48 in (available on request).
Further information about Surf on page 305.*

Mosaic

Floor Tiles

5 x 5 cm¹



15 x 15 cm



30 x 60 cm¹



30 x 60 cm¹



60 x 60 cm¹



60 x 60 cm¹



60 x 120 cm¹

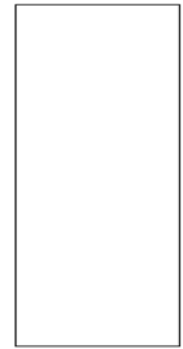

Mosaic, glass fibre net on reverse side
Sheet: 297 x 297 mm

Model number	7161H	342030H	B200HK	B200HK	B600HK	B600HK	B670HK
Nom. dim. - cm/in	5 x 5 / 2 x 2	15 x 15 / 6 x 6	30 x 60 / 12 x 24	30 x 60 / 12 x 24	60 x 60 / 24 x 24	60 x 60 / 24 x 24	60 x 120 / 24 x 48
Work size	47 x 47 x 8 mm	147 x 147 x 8 mm	297 x 597 x 8 mm	297 x 597 x 8 mm	597 x 597 x 8 mm	597 x 597 x 8 mm	597 x 1197 x 8 mm
Surface	structured, matt	structured, matt	structured, matt	structured, matt	structured, matt	structured, matt	structured, matt
m ² - pieces	11.111	44.444	5.556	5.556	2.778	2.778	1.388
m ² - kg	16.389	17.555	17.413	17.413	18.001	18.001	17.489
Bundle - pieces	14	35	6	6	4	4	2
Bundle - m ²	1.260	0.788	1.080	1.080	1.440	1.440	1.441
Bundle - kg	20.650	13.825	18.804	18.804	25.920	25.920	25.200
Pallet - m ²	37.800	63.001	43.197	43.197	43.197	43.197	36.023
Pallet - kg	619.500	1,106.000	752.160	752.160	777.600	777.600	630.000
Product standard	Alb	Bla	Alb	Alb	Alb	Alb	Alb
Slip resistance	R11/B	R11/C	R10/A	R11/B	R10/A	R11/B	R10/A
Stress group	2	2	2	2	2	2	2
lime	8810-7161H Price gr. A289 (m ²)	8810-342030H Price gr. A157 (m ²)	8800-B200HK Price gr. A136 (m ²)	8810-B200HK Price gr. A157 (m ²)	8800-B600HK Price gr. A154 (m ²)	8810-B600HK Price gr. A181 (m ²)	8800-B670HK Price gr. A181 (m ²)
beige	8811-7161H Price gr. A289 (m ²)	8811-342030H Price gr. A157 (m ²)	8801-B200HK Price gr. A136 (m ²)	8811-B200HK Price gr. A157 (m ²)	8801-B600HK Price gr. A154 (m ²)	8811-B600HK Price gr. A181 (m ²)	8801-B670HK Price gr. A181 (m ²)
brown	8812-7161H Price gr. A289 (m ²)	8812-342030H Price gr. A157 (m ²)	8802-B200HK Price gr. A136 (m ²)	8812-B200HK Price gr. A157 (m ²)	8802-B600HK Price gr. A154 (m ²)	8812-B600HK Price gr. A181 (m ²)	8802-B670HK Price gr. A181 (m ²)
grey	8813-7161H Price gr. A289 (m ²)	8813-342030H Price gr. A157 (m ²)	8803-B200HK Price gr. A136 (m ²)	8813-B200HK Price gr. A157 (m ²)	8803-B600HK Price gr. A154 (m ²)	8813-B600HK Price gr. A181 (m ²)	8803-B670HK Price gr. A181 (m ²)
anthracite	8814-7161H Price gr. A289 (m ²)	8814-342030H Price gr. A157 (m ²)	8804-B200HK Price gr. A136 (m ²)	8814-B200HK Price gr. A157 (m ²)	8804-B600HK Price gr. A154 (m ²)	8814-B600HK Price gr. A181 (m ²)	8804-B670HK Price gr. A181 (m ²)



Skirting, cut

6 x 60 cm¹



Model number	B611HK					
Nom. dim. - cm/in	6 x 60 / 2 3/8 x 24					
Work size	60 x 597 x 8 mm					
Surface	structured, matt					
m - pieces	1.667					
m - kg	1.100					
Bundle - pieces	34					
Bundle - m	20.396					
Bundle - kg	22.440					
Pallet - m						
Pallet - kg						
Product standard	Alb					
lime	8800-B611HK Price gr. A434 (pce.)					
beige	8801-B611HK Price gr. A434 (pce.)					
brown	8802-B611HK Price gr. A434 (pce.)					
grey	8803-B611HK Price gr. A434 (pce.)					
anthracite	8804-B611HK Price gr. A434 (pce.)					



¹ rectified

All products: Color Shade Variation V4

Studio photo / Architect: VSBL, Belgrade, Serbia / Series: Savona / Photo: Jochen Stüber





Studio photo / Architect: VSBL, Belgrade, Serbia / Series: Streetlife / Photo: Jochen Stüber





Cool and urban

Asphalt characterizes the image of urban streets and squares. And it gives the Streetlife floor tile its thoroughly urban look. The typical features such as grainy structures, small unevennesses and cracked textures create a floor covering which is as timeless as it is distinctive and, with a thickness of 10.5 mm, has been specially designed for public applications. Areas of application could be hotels, schools, office buildings and modern shopfitting.



rust



Floor tile 60 x 60 cm, 24 x 24 in, structured, R10



Floor tile 60 x 90 cm, 24 x 36 in, structured, R10



Floor tile 60 x 120 cm, 24 x 48 in, structured, R10



Stair tile 30 x 120 cm, 12 x 48 (with grooves), structured, R10



Skirting, cut 6 x 60 cm, 2 3/8 x 20 in, structured

Floor Tiles¹

Stair Tile^{1/2}

Skirting, cut¹

60 x 60 cm



60 x 90 cm



60 x 120 cm



30 x 120 cm



6 x 60 cm



Model number	B700HK	B755HK	B770HK	B729HK	B710HK		
Nom. dim. - cm/in	60 x 60 / 24 x 24	60 x 90 / 24 x 36	60 x 120 / 24 x 48	30 x 120 / 12 x 48	6 x 60 / 2 3/8 x 24		
Work size	597 x 597 x 10.5 mm	597 x 897 x 10.5 mm	597 x 1197 x 10.5 mm	297 x 1197 x 10.5 mm	60 x 597 x 10.5 mm		
Surface	structured, matt	structured, matt	structured, matt	structured, matt	structured, matt		
m ² /m - pieces	2.778/m ²	1.851/m ²	1.390/m ²	0.833/m	1.667/m		
m ² /m - kg	23.335/m ²	23.367/m ²	23.839/m ²	6.427/m	1.445/m		
Bundle - pieces	3	2	2	3	24		
Bundle - m ² /m	1.080 m ²	1.080 m ²	1.441 m ²	3.601 m	14.397 m		
Bundle - kg	25.200	25.248	34.300	23.148	20.808		
Pallet - m ²	32.397	22.680	30.259				
Pallet - kg	756.000	530.208	720.300				
Product standard	Alb	Alb	Alb	Alb	Alb		
Slip resistance	R10	R10	R10	R10			
Stress group	2 - 3	2 - 3	2 - 3	2 - 3			
	8823-B700HK	8823-B755HK	8823-B770HK	8823-B729HK	8823-B710HK		
rust	Price gr. A154 (m ²)	Price gr. A154 (m ²)	Price gr. A178 (m ²)	Price gr. A560 (pce.)	Price gr. A438 (pce.)		



¹  rectified

²  Make-to-order production: return and/or cancellation of ordered products not possible.

All products: Color Shade Variation V4

Studio photo / Architect: VSBL, Belgrade, Serbia / Series: Streetlife / Photo: Jochen Stüber





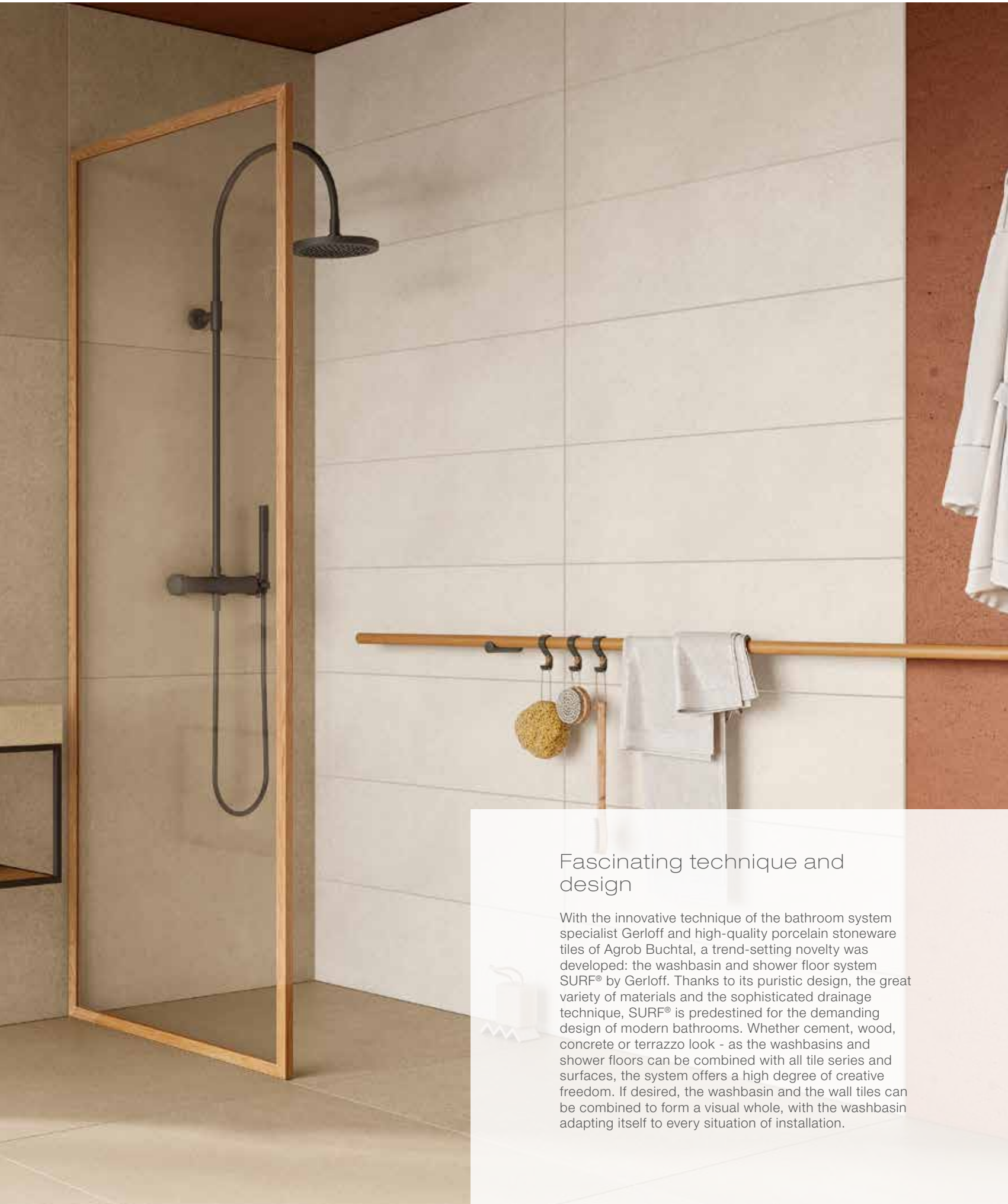

Fascinating technique and design

With the innovative technique of the bathroom system specialist Gerloff and high-quality porcelain stoneware tiles of Agrob Buchtal, a trend-setting novelty was developed: the washbasin and shower floor system SURF® by Gerloff. Thanks to its puristic design, the great variety of materials and the sophisticated drainage technique, SURF® is predestined for the demanding design of modern bathrooms. Whether cement, wood, concrete or terrazzo look - as the washbasins and shower floors can be combined with all tile series and surfaces, the system offers a high degree of creative freedom. If desired, the washbasin and the wall tiles can be combined to form a visual whole, with the washbasin adapting itself to every situation of installation.

The aesthetic tile washbasin

The washbasin is available in the three sizes SMALL (40 x 60 cm), MEDIUM (45 x 80 cm) and LARGE (55 x 120 cm). By the appropriate choice of the surfaces and the combination with matching large-size wall tiles, the washbasin and the wall can be designed as a visual whole.

Noble and versatile

- » Consistent puristic design
- » Different surfaces
- » Suitable for every situation of installation
- » Low-cost
- » Connection to all commercially available drain valves
- » Easy to clean
- » Jointless
- » Quick, simple installation





Washbasin SURF®

small	40 x 60 cm
medium	45 x 80 cm
large	55 x 120 cm

Note: The washbasin is supplied inclusive of the discharge cover, the matching drain outlet "Clou" and the appropriate support. The size and position of the tap hole have to be checked by the customer.



Double washbasin SURF®

large	55 x 120 cm
--------------	-------------

Note: The washbasin is supplied inclusive of the discharge cover, the matching drain outlet "Clou" and the appropriate support. The size and position of the tap hole have to be checked by the customer.



Washbasin with matching console SURF®

medium	45 x 80 cm
large	55 x 120 cm

Upon request, it is possible to combine the washbasin and the console from different series.

Ideal tiles for the design shower

The shower floor of the respective series is available in two versions: as SURF® Basic with metal discharge cover or SURF® Slot with the elegant, practically invisible tile discharge cover. The drainage technique is incorporated in the tile completely ready for laying.



Beautiful and functional

- » Minimalist design
- » Different surfaces
- » Jointless
- » Easy to clean
- » Syphon screwed to the tile in a watertight manner
- » Low-cost
- » Quick, simple installation

Supplied in the rigid foam block, with sealing material and discharge cover.

* Other versions also possible on request, see the following page.



Other versions available on request:

30 x 60 cm



Variant A



Variant B



Variant C



Variant D
Grooved tile without outlet



Variant E



Variant F
Grooved tile without outlet

60 x 60 cm



Variant A

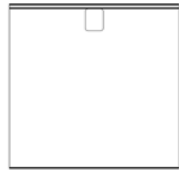

Variant B



Variant C



Variant D
Grooved tile without outlet

60 x 120 cm

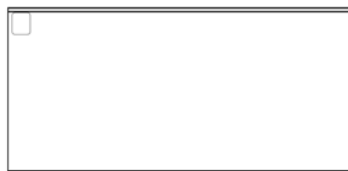

Variant A



Variant B



Variant C



Variant D
Grooved tile without outlet



Variant E



Variant F
Grooved tile without outlet



Shower floor system Basic with metal discharge cover



Shower floor system Slot with tile discharge cover

Washbasin and shower floor – the surfaces

Area Pro

WTS WTB WTL DTB DTL 



Nova

WTS WTB WTL DWT
KSM KSL DTB DTL 



Savona

WTS WTB WTL DWT
KSM KSL DTB DTL 



Streetlife

WTS WTB WTL DWT
KSM KSL DTB DTL 

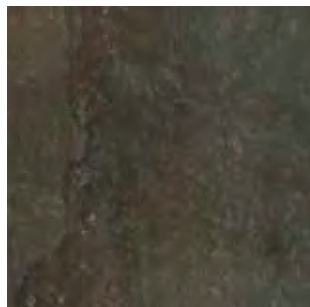

Unique

WTS WTB WTL DWT
KSM KSL DTB DTL 



Washbasin with matching console SURF^{®1/2}

Washbasin SURF^{®1/2}

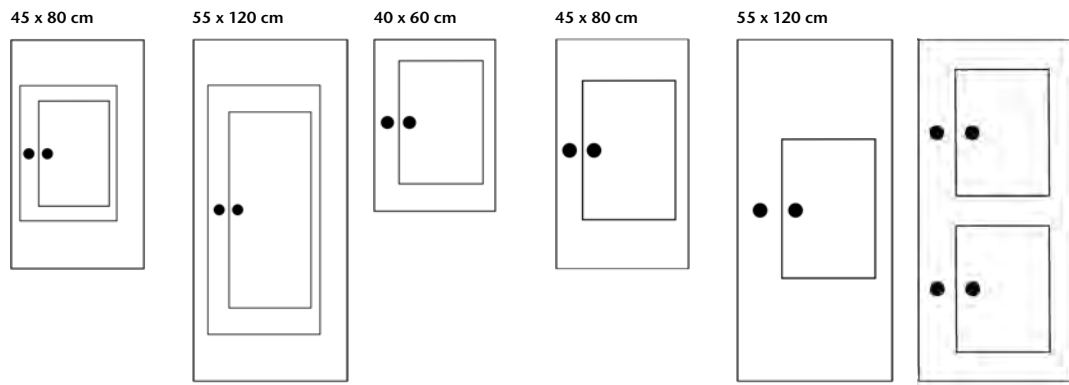

	Medium	Large	Small	Medium	Large	Large	
	45 x 80 / 16 x 32	55 x 120 / 22 x 48	40 x 60 / 18 x 24	45 x 80 / 16 x 32	55 x 120 / 22 x 48	55 x 120 / 22 x 48	Nom. dim. - cm/in
	450 x 800 x 160 mm	550 x 1197 x 160 mm	400 x 597 x 95 mm	450 x 800 x 95 mm	550 x 1197 x 95 mm	550 x 1197 x 95 mm	Work size
							Surface
							pieces
							- kg
	1	1	1	1	1	1	Bundle - pieces
							Bundle
	50.000	62.000	27.500	35.000	52.000	52.000	Bundle - kg
							Pallet
							Pallet
							Product standard
	430407HKSM Price gr. A853 (pce.)	430407HKSL Price gr. A854 (pce.)	430407HWTS Price gr. A847 (pce.)	430407HWTB Price gr. A849 (pce.)	430407HWTL Price gr. A852 (pce.)	430407HDWTL Price gr. A854 (pce.)	

¹  Make-to-order production: return and/or cancellation of ordered products not possible.

Drainage system SURF[®] by Gerloff

² The size and position of the tap hole have to be checked by the customer.



Shower floor SURF^{®1/2}

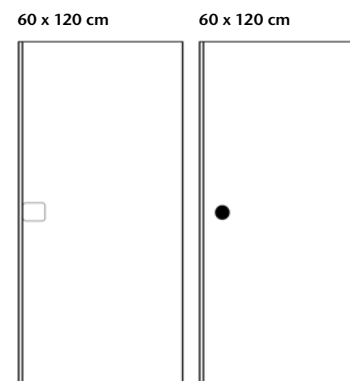

	Basic	Slot	
	60 x 120 / 24 x 48	60 x 120 / 24 x 48	Nom. dim. - cm/in
	597 x 1197 x 120 mm	597 x 1197 x 120 mm	Work size
			Surface
			pieces
			- kg
	1	1	Bundle - pieces
			Bundle
	17.635	17.889	Bundle - kg
			Pallet
			Pallet
			Product standard
	430407HDTB Price gr. A835 (pce.)	430407HDTL Price gr. A837 (pce.)	

¹  Make-to-order production: return and/or cancellation of ordered products not possible.

Drainage system SURF[®] by Gerloff

² Other versions also possible on request, refer to page 309

All products: Color Shade Variation V2



Studio photo / Architect: VSBL, Belgrade, Serbia / Series: Trias / Photo: Jochen Stüber





Elementary, modern, representative

With its clear, authentic look and the slip-resistance categories R10/A and R11/B, Trias is almost predestined for modern bathroom design for floors and walls. Numerous format variants are available in zinc-grey, iron ore, sand-yellow, earth-brown or calcite-white: from the decorative 5 cm mosaic to representative tiles. The Protecta-upgraded series Trias is suitable both for wet areas and for all living areas.



R10/A R11/B



calcit-white



zinc-grey

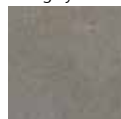

iron ore



sand-yellow



earth-brown



Floor/Wall tile 30 x 60 cm, 12 x 24 in, structured, R10/B
Floor/Wall tile 30 x 60 cm, 12 x 24 in, structured, R11/B



Floor/Wall tile 60 x 60 cm, 24 x 24 in, structured, R10/A



Treppenfliese 30 x 60 cm, 12 x 24 in (with grooves), structured, R10/A



Skirting, rounded 7 x 60 cm, 2 13/16 x 24 in, structured

Mosaic 5 x 5 cm, 2 x 2 in



Mosaic sheet 30 x 30 cm, 12 x 12 in structured, R11/B



Mosaic sheet 30 x 30 cm, 12 x 12 in structured, R11/B



Mosaic sheet 30 x 30 cm, 12 x 12 in structured, R11/B



Mosaic sheet 30 x 30 cm, 12 x 12 in structured, R11/B



Mosaic sheet 30 x 30 cm, 12 x 12 in structured, R11/B

Mosaic¹

5 x 5 cm



Floor Tiles¹

30 x 60 cm



30 x 60 cm



60 x 60 cm



Stair Tiles²

30 x 60 cm

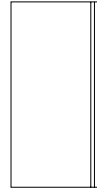

Skirting, rounded¹

7 x 60 cm



Mosaic, glass fibre net
on reverse side
Sheet: 297 x 297 mm

Nom. dim. - cm/in	5 x 5 / 2 x 2	30 x 60 / 12 x 24	30 x 60 / 12 x 24	60 x 60 / 24 x 24	30 x 60 / 12 x 24	7 x 60 / 2 13/16 x 24
Work size	47 x 47 x 10.0 mm	297 x 596 x 10.0 mm	297 x 596 x 10.0 mm	596 x 596 x 10.0 mm	297 x 596 x 10.0 mm	70 x 596 x 10.0 mm
Surface	structured, matt	structured, matt	structured, matt	structured, matt	structured, matt	structured, matt
m ² /m - pieces	11.111 sheets/m ²	5.556/m ²	5.556/m ²	2.778/m ²	1.667/m	1.667/m
m ² /m - kg	21.800/m ²	21.724/m ²	21.724/m ²	22.780/m ²	6.968/m	1.550/m
Bundle - pieces	11 sheets	6	6	3	6	22
Bundle - m ² /m	0.990/m ²	1.080/m ²	1.080/m ²	1.080/m ²	3.599/m	13.197/m
Bundle - kg	21.582	23.460	23.460	24.600	25.080	20.460
Pallet - m ²	29.700	43.197	43.197	43.197		
Pallet - kg	647.460	938.400	938.400	984.000		
Product standard	Bla	Bla	Bla	Bla	Bla	Bla
Slip resistance	R11/B	R10/A	R11/B	R10/A	R10/A	
Stress group	1 - 2	1 - 2	1 - 2	1 - 2	1 - 2	
	052265	052225	052230	052240	<i>052235</i>	052245
calcite-white	Price gr. A286 (m ²)	Price gr. A100 (m ²)	Price gr. A115 (m ²)	Price gr. A115 (m ²)	Price gr. A475 (pce.)	Price gr. A438 (pce.)
	052266	052226	052231	052241	<i>052236</i>	052246
zinc-grey	Price gr. A286 (m ²)	Price gr. A100 (m ²)	Price gr. A115 (m ²)	Price gr. A115 (m ²)	Price gr. A475 (pce.)	Price gr. A438 (pce.)
	052267	052227	052232	052242	<i>052237</i>	052247
iron ore	Price gr. A286 (m ²)	Price gr. A100 (m ²)	Price gr. A115 (m ²)	Price gr. A115 (m ²)	Price gr. A475 (pce.)	Price gr. A438 (pce.)
	052268	052228	052233	052243	<i>052238</i>	052248
sand-yellow	Price gr. A286 (m ²)	Price gr. A100 (m ²)	Price gr. A115 (m ²)	Price gr. A115 (m ²)	Price gr. A475 (pce.)	Price gr. A438 (pce.)
	052269	052229	052234	052244	<i>052239</i>	052249
earth-brown	Price gr. A286 (m ²)	Price gr. A100 (m ²)	Price gr. A115 (m ²)	Price gr. A115 (m ²)	Price gr. A475 (pce.)	Price gr. A438 (pce.)



¹ rectified

² Make-to-order production: return and/or cancellation of ordered products not possible.

All products: Color Shade Variation V3

Studio photo / Architect: VSBL, Belgrade, Serbia / Series: Trias / Photo: Jochen Stüber





Project: Head office of pbr Planungsbüro Rohling AG / Location: Osnabrück, Germany /
Architect: pbr Planungsbüro Rohling AG, Osnabrück / Series: Unique / Photo: Martin Lukas Kim Fotografie, Hamburg





Expressive and versatile

With eight formats, eight colors and three slip-resistance categories as well as a matching wall tile and a special steel strip as decoration, the Unique series is suitable for many areas of application. The color spectrum of the Protecta-upgraded porcelain stoneware floor tiles, which ranges from beige to basalt and through to anthracite, the slightly structured, discreet surface as well as the slip-resistance categories R10/A, R10/B and R11/B enable versatile use, also in wet areas.

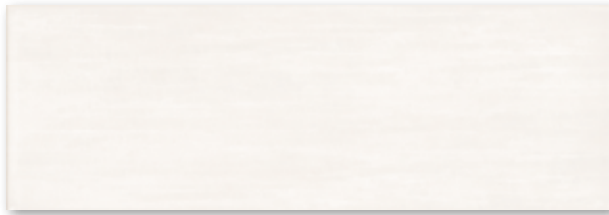

Wall tile 20 x 60 cm, 8 x 24 in, white, smooth



Special steel strips 5 x 60 cm, 2 x 24 in, smooth

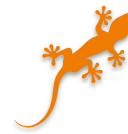

R10/A R10/B R11/B



anthracite



basalt



light-grey



beige

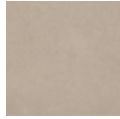

brown



mud-brown

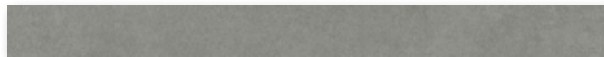

Oblong format 5 x 60 cm, 2 x 24 in, smooth, R10/A

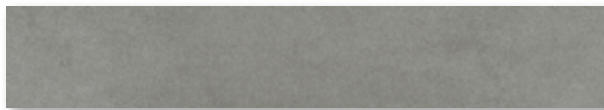

Oblong format 10 x 60 cm, 4 x 24 in, smooth, R10/A

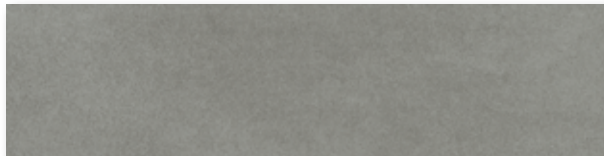

Oblong format 15 x 60 cm, 6 x 24 in, smooth, R10/A



Floor tile 30 x 30 cm, 12 x 12 in, smooth, R10/A



Floor tile 30 x 60 cm, 12 x 24 in, smooth, R10/A
Floor tile 30 x 60 cm, 12 x 24 in, smooth, R11/B

Mosaic 5 x 5 cm, 2 x 2 in

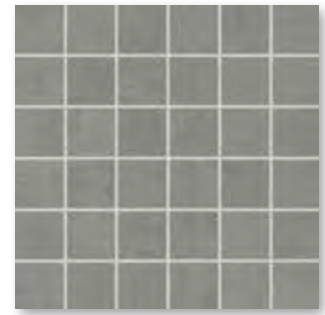

Mosaic sheet 30 x 30 cm, 12 x 12 in structured, R10/B



R10/A

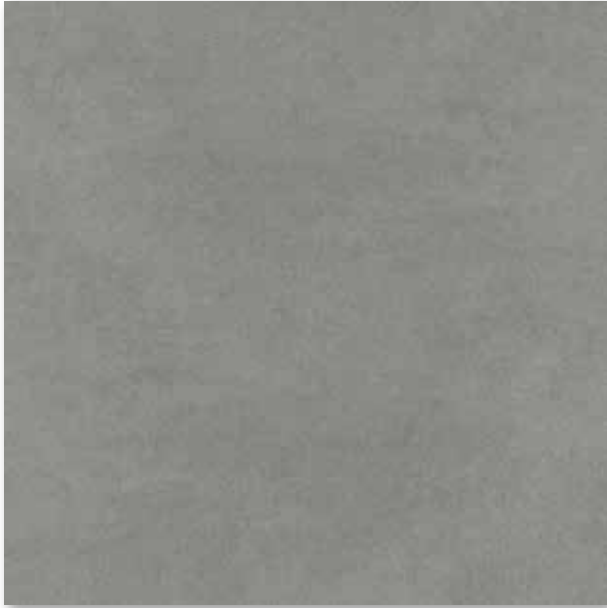

Floor tile 60 x 60 cm, 24 x 24 in, smooth, R10/A



Stair tile 30 x 60 cm, 12 x 24 in (with grooves), smooth, R10/A



Skirting, rounded 7 x 60 cm, 2 13/16 x 24 in, smooth

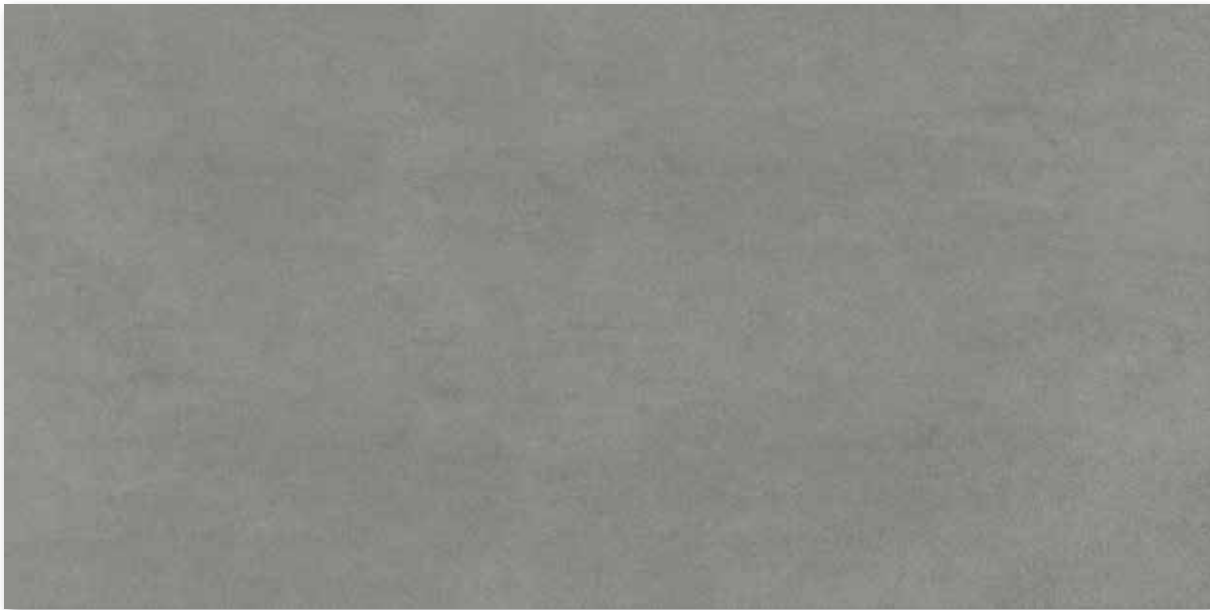

Floor tile 60 x 120 cm, 24 x 48 in, smooth, R10/A

Wall Tile

Special Steel Strip²

20 x 60 cm

5 x 60 cm



Nom. dim. - cm/in	20 x 60 / 8 x 24	5 x 60 / 2 x 24				
Work size	197 x 597 x 9 mm	47 x 597 x 10 mm				
Surface	smooth, matt	smooth, matt				
m ² /m - pieces	8.333/m ²	1.667/m				
m ² /m - kg	15.516/m ²	0.917/m				
Bundle - pieces	8	3				
Bundle - m ² /m	0.960 m ²	1.800 m				
Bundle - kg	14.896	1.650				
Pallet - m ²	61.442					
Pallet - kg	953.344					
Product standard	BIII					
	381799H					
white	Price gr. A64 (m ²)					
special steel		436698 Price gr. A519 (pce.)				

² without Hytect-coating

Mosaic¹

Floor Tiles¹

5 x 5 cm

5 x 60 cm²

10 x 60 cm²

15 x 60 cm²

30 x 30 cm

30 x 60 cm

30 x 60 cm



Mosaic, glass fibre net on reverse side

Sheet: 297x297 mm

Oblong format

Oblong format

Oblong format

Nom. dim. - cm/in	5 x 5 / 2 x 2	5 x 60 / 2 x 24	10 x 60 / 4 x 24	15 x 60 / 6 x 24	30 x 30 / 12 x 12	30 x 60 / 12 x 24	30 x 60 / 12 x 24
Work size	47 x 47 x 10.5 mm	47 x 597 x 10.5 mm	97 x 597 x 10.5 mm	147 x 597 x 10.5 mm	297 x 297 x 10.5 mm	297 x 597 x 10.5 mm	297 x 597 x 10.5 mm
Surface	structured, matt	smooth, matt	smooth, matt	smooth, matt	smooth, matt	smooth, matt	smooth, matt
m ² - pieces	11.111	33.333	16.667	11.111	11.111	5.556	5.556
m ² - kg	21.966	21.966	21.967	21.966	21.966	21.974	21.974
Bundle - pieces	11 sheets	33	15	11	11	6	6
Bundle - m ²	0.990	0.990	0.900	0.990	0.990	1.080	1.080
Bundle - kg	21.747	21.747	19.770	21.747	21.747	23.730	23.730
Pallet - m ²	29.700	39.600	35.999	39.600	41.580	43.197	43.197
Pallet - kg	652.410	869.880	790.800	869.880	913.374	949.200	949.200
Product standard	Alb	Alb	Alb	Alb	Alb	Alb	Alb
Slip resistance	R10/B	R10/A	R10/A	R10/A	R10/A	R10/A	R11/B
Stress group	1 - 2	2 - 3	2 - 3	2 - 3	2 - 3	2 - 3	2 - 3
	433793	433787	433770	433778	433841	433671	434414
anthracite	Price gr. A265 (m ²)	Price gr. A211 (m ²)	Price gr. A211 (m ²)	Price gr. A199 (m ²)	Price gr. A115 (m ²)	Price gr. A127 (m ²)	Price gr. A136 (m ²)
	433794	433786	433771	433779	433842	433672	434415
basalt	Price gr. A265 (m ²)	Price gr. A211 (m ²)	Price gr. A211 (m ²)	Price gr. A199 (m ²)	Price gr. A115 (m ²)	Price gr. A127 (m ²)	Price gr. A136 (m ²)
	433795	433789	433772	433780	433843	433673	434416
light grey	Price gr. A265 (m ²)	Price gr. A211 (m ²)	Price gr. A211 (m ²)	Price gr. A199 (m ²)	Price gr. A115 (m ²)	Price gr. A127 (m ²)	Price gr. A136 (m ²)
	433796	433891	433773	433781	433844	433674	434417
beige	Price gr. A265 (m ²)	Price gr. A211 (m ²)	Price gr. A211 (m ²)	Price gr. A199 (m ²)	Price gr. A115 (m ²)	Price gr. A127 (m ²)	Price gr. A136 (m ²)
	433797	433788	433774	433782	433846	433675	434418
mud	Price gr. A265 (m ²)	Price gr. A211 (m ²)	Price gr. A211 (m ²)	Price gr. A199 (m ²)	Price gr. A115 (m ²)	Price gr. A127 (m ²)	Price gr. A136 (m ²)
	433799	433893	433776	433784	433848	433677	434445
brown	Price gr. A265 (m ²)	Price gr. A211 (m ²)	Price gr. A211 (m ²)	Price gr. A199 (m ²)	Price gr. A115 (m ²)	Price gr. A127 (m ²)	Price gr. A136 (m ²)



¹ rectified



² Make-to-order production: return and/or cancellation of ordered products not possible.



All products: Color Shade Variation V2

Floor Tiles¹

Stair Tiles^{1/2}

Skirting, rounded¹

60 x 60 cm

60 x 120 cm

30 x 60 cm

7 x 60 cm



protected

	60 x 60 / 24 x 24	60 x 120 / 24 x 48	30 x 60 / 12 x 24	7 x 60 / 2 13/16 x 24	
	597 x 597 x 10.5 mm	597 x 1197 x 8 mm	297 x 597 x 10.5 mm	70 x 597 x 10.5 mm	Nom. dim. - cm/in
	smooth, matt	smooth, matt	smooth, matt	smooth, matt	Work size
	2.778/m ²	1.388/m ²	1.667/m	1.667/m	Surface
	21.996/m ²	17.489/m ²	6.593/m	1.554/m	m ² /m - pieces
	3	2	6	15	m ² /m - kg
	1.080 m ²	1.441 m ²	3.599 m	8.998 m	Bundle - pieces
	23.754	25.200	23.730	13.980	Bundle - m ² /m
	32.397	36.023			Bundle - kg
	712.620	630.000			Pallet - m ²
	Alb	Alb	Alb	Alb	Pallet - kg
	R10/A	R10/A	R10/A		Product standard
	2 - 3	2 - 3	2 - 3		Slip resistance
	433701	434432	433678	433685	Stress group
	Price gr. A142 (m ²)	Price gr. A169 (m ²)	Price gr. A465 (pce.)	Price gr. A441 (pce.)	anthracite
	433702	434433	433679	433686	basalt
	Price gr. A142 (m ²)	Price gr. A169 (m ²)	Price gr. A465 (pce.)	Price gr. A441 (pce.)	light grey
	433703	434434	433680	433687	beige
	Price gr. A142 (m ²)	Price gr. A169 (m ²)	Price gr. A465 (pce.)	Price gr. A441 (pce.)	mud
	433704	434435	433681	433688	brown
	Price gr. A142 (m ²)	Price gr. A169 (m ²)	Price gr. A465 (pce.)	Price gr. A441 (pce.)	
	433705	434436	433682	433689	
	Price gr. A142 (m ²)	Price gr. A169 (m ²)	Price gr. A465 (pce.)	Price gr. A441 (pce.)	
	433707	434438	433684	433691	
	Price gr. A142 (m ²)	Price gr. A169 (m ²)	Price gr. A465 (pce.)	Price gr. A441 (pce.)	

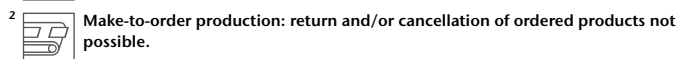

All products: Color Shade Variation V2





Natural and lively

The Valley porcelain stoneware series was inspired by the panorama of the distant landscape of a valley plain. Its earthy relief and its fine, grainy textures bear witness to this. Each color evokes different associations: of blue or clay slate, river pebbles, sand and earth. The effects of the weather, earth movements, water flows and metallic material deposits also create a lively surface with a typical "mountain-valley" effect. Produced with digital printing technology, Valley has up to 26 different tile patterns. The series is rounded off by an extra thick, frost-resistant patio tile in all four colors, which is also suitable for laying in sand or gravel.



R10/A R10/B R11/B



slate



pebble-grey



earth-brown



sand-beige



Oblong format 5 x 60 cm, 2 x 24 in, structured, R10/A



Oblong format 10 x 60 cm, 4 x 24 in, structured, R10/A



Oblong format 15 x 60 cm, 6 x 24 in, structured, R10/A



Oblong format 20 x 60 cm, 8 x 24 in, structured, R10/A

Mosaic 5 x 5 cm, 2 x 2 in



Mosaic sheet 30 x 30 cm, 12 x 12 in smooth, R11/B



Floor/wall tile 15 x 15 cm, 6 x 6 in structured, R10/B



Floor/wall tile 30 x 30 cm, 12 x 12 in structured, R11/B



Floor/wall tile 30 x 60 cm, 12 x 24 in, structured, R10/A
Floor/wall tile 30 x 60 cm, 12 x 24 in, structured, R11/B



Floor tile 60 x 60 cm, 24 x 24 in, structured, R10/A
Patio tile 60 x 60 cm, 24 x 24 in, structured, R11/B

Ceramic cover channel*,
25 x 50 cm, 10 x 20 in



Ceramic cover channel*,
corner solution 30 x 30 cm,
12 x 12 in



without illustration:
Gutter tile with outlet,
mitred pair, terminal piece

*For details, refer to the chapter Pool + Spa; Ceramic channel cover 2.0,
page 451 (make-to-order production).



Floor tile 60 x 120 cm, 24 x 48 in, structured, R10/A



Skirting, rounded 7 x 60 cm, 2 13/16 x 24 in



Stair tile 30 x 60 cm, 12 x 24 in (with grooves), structured, R10/A

Mosaic¹

Floor/Wall Tiles¹

5 x 5 cm



15 x 15 cm



5 x 60 cm²



10 x 60 cm²



15 x 60 cm²



20 x 60 cm²



Mosaic, glass fibre net on reverse side
Sheet: 297 x 297 mm

Oblong format

Oblong format

Oblong format

Oblong format

Nom. dim. - cm/in	5 x 5 / 2 x 2	15 x 15 / 6 x 6	5 x 60 / 2 x 24	10 x 60 / 4 x 24	15 x 60 / 6 x 24	20 x 60 / 8 x 24
Work size	47 x 47 x 10 mm	147 x 147 x 8 mm	46 x 596 x 10 mm	96 x 596 x 10 mm	146 x 596 x 10 mm	196 x 596 x 10 mm
Surface	structured, matt	structured, matt	structured, matt	structured, matt	structured, matt	structured, matt
m ² - pieces	11.111	44.444	33.333	16.667	11.111	8.333
m ² - kg	21.800	17.555	22.233	22.667	22.000	23.749
Bundle - pieces	11 sheets	35	33	15	11	8
Bundle - m ²	0.990	0.788	0.990	0.900	0.990	0.960
Bundle - kg	21.582	13.825	22.011	20.400	21.780	22.800
Pallet - m ²	29.700	63.001	39.600	35.999	39.600	40.322
Pallet - kg	647.460	1,106.000	880.440	816.000	871.200	957.600
Product standard	Bla	Bla	Bla	Bla	Bla	Bla
Slip resistance	R11/B	R10/B	R10/A	R10/A	R10/A	R10/A
Stress group	2 - 3	2	2 - 3	2 - 3	2 - 3	2 - 3
slate	052089 Price gr. A292 (m ²)	052477 Price gr. A142 (m ²)	<i>052044</i> Price gr. A217 (m ²)	<i>052048</i> Price gr. A217 (m ²)	<i>052052</i> Price gr. A211 (m ²)	<i>052461</i> Price gr. A211 (m ²)
pebble-grey	052090 Price gr. A292 (m ²)	052478 Price gr. A142 (m ²)	<i>052045</i> Price gr. A217 (m ²)	<i>052049</i> Price gr. A217 (m ²)	<i>052053</i> Price gr. A211 (m ²)	<i>052462</i> Price gr. A211 (m ²)
earth-brown	052091 Price gr. A292 (m ²)	052479 Price gr. A142 (m ²)	<i>052046</i> Price gr. A217 (m ²)	<i>052050</i> Price gr. A217 (m ²)	<i>052054</i> Price gr. A211 (m ²)	<i>052463</i> Price gr. A211 (m ²)
sand-beige	052092 Price gr. A292 (m ²)	052480 Price gr. A142 (m ²)	<i>052047</i> Price gr. A217 (m ²)	<i>052051</i> Price gr. A217 (m ²)	<i>052055</i> Price gr. A211 (m ²)	<i>052464</i> Price gr. A211 (m ²)



² Make-to-order production: return and/or cancellation of ordered products not possible.

All products: Color Shade Variation V2

Floor/Wall Tiles¹

30 x 30 cm



30 x 60 cm



30 x 60 cm



60 x 60 cm



60 x 120 cm^{2/3}



Nom. dim. - cm/in	30 x 30 / 12 x 12	30 x 60 / 12 x 24	30 x 60 / 12 x 24	60 x 60 / 24 x 24	60 x 120 / 24 x 48
Work size	297 x 297 x 10 mm	297 x 596 x 10 mm	297 x 596 x 10 mm	596 x 596 x 10 mm	596 x 1195 x 10.5 mm
Surface	structured, matt	structured, matt	structured, matt	structured, matt	structured, matt
m ² - pieces	11.111	5.556	5.556	2.778	1.388
m ² - kg	23.144	22.780	22.780	22.780	23.180
Bundle - pieces	11	6	6	3	2
Bundle - m ²	0.990	1.080	1.080	1.080	1.441
Bundle - kg	22.913	24.600	24.600	24.600	33.400
Pallet - m ²	41.580	43.197	43.197	43.197	21.614
Pallet - kg	962.346	984.000	984.000	984.000	501.000
Product standard	Bla	Bla	Bla	Bla	Bla
Slip resistance	R11/B	R10/A	R11/B	R10/A	R10/A
Stress group	2 - 3	2 - 3	2 - 3	2 - 3	2 - 3
slate	052032 Price gr. A121 (m ²)	052016 Price gr. A109 (m ²)	052036 Price gr. A121 (m ²)	052020 Price gr. A121 (m ²)	052024 Price gr. A154 (m ²)
pebble-grey	052033 Price gr. A121 (m ²)	052017 Price gr. A109 (m ²)	052037 Price gr. A121 (m ²)	052021 Price gr. A121 (m ²)	052025 Price gr. A154 (m ²)
earth-brown	052034 Price gr. A121 (m ²)	052018 Price gr. A109 (m ²)	052038 Price gr. A121 (m ²)	052022 Price gr. A121 (m ²)	052026 Price gr. A154 (m ²)
sand-beige	052035 Price gr. A121 (m ²)	052019 Price gr. A109 (m ²)	052039 Price gr. A121 (m ²)	052023 Price gr. A121 (m ²)	052027 Price gr. A154 (m ²)



All products: Color Shade Variation V2
Large formats are marketed in crates for an extra charge.

² High weight only to carry with two persons.
³ Please note: special pallet. No return, no exchange.

Patio Tile^{1/2}

Stair Tile^{1/3}

Skirting,
rounded¹

60 x 60 cm



30 x 60 cm



7 x 60 cm



protected

				60 x 60 / 24 x 24	30 x 60 / 12 x 24	7 x 60 / 2 13/16 x 24	Nom. dim. - cm/in
				596 x 596 x 20 mm	297 x 596 x 10 mm	70 x 596 x 10 mm	Work size
				structured, matt	structured, matt	structured, matt	Surface
				2.778/m ²	1.667/m	1.667/m	m ² /m - pieces
				46.948/m ²	6.968/m	1.550/m	m ² /m - kg
				2	6	22	Bundle - pieces
				0.720 m ²	3.599 m	13.197 m	Bundle - m ² /m
				33.800	25.080	20.460	Bundle - kg
				21.598			Pallet - m ²
				1,014.000			Pallet - kg
				Bla	Bla	Bla	Product standard
				R11/B	R10/A		Slip resistance
				4	2 - 3		Stress group
				052085	052068	052072	slate
				Price gr. A239 (m ²)	Price gr. A475 (pce.)	Price gr. A438 (pce.)	
				052086	052069	052073	pebble-grey
				Price gr. A239 (m ²)	Price gr. A475 (pce.)	Price gr. A438 (pce.)	
				052087	052070	052074	earth-brown
				Price gr. A239 (m ²)	Price gr. A475 (pce.)	Price gr. A438 (pce.)	
				052088	052071	052075	sand-beige
				Price gr. A239 (m ²)	Price gr. A475 (pce.)	Price gr. A438 (pce.)	

¹ rectified

² High weight only to carry with two persons.

³ Make-to-order production: return and/or cancellation of ordered products not possible.



All products: Color Shade Variation V2





Pool + Spa

Project: Paracelsus Bad & Kurhaus / Location: Salzburg, Austria / Architect: Berger + Parkkinen / Series: Pool edge system Wiesbaden, Savona / Photo: Christian Richters



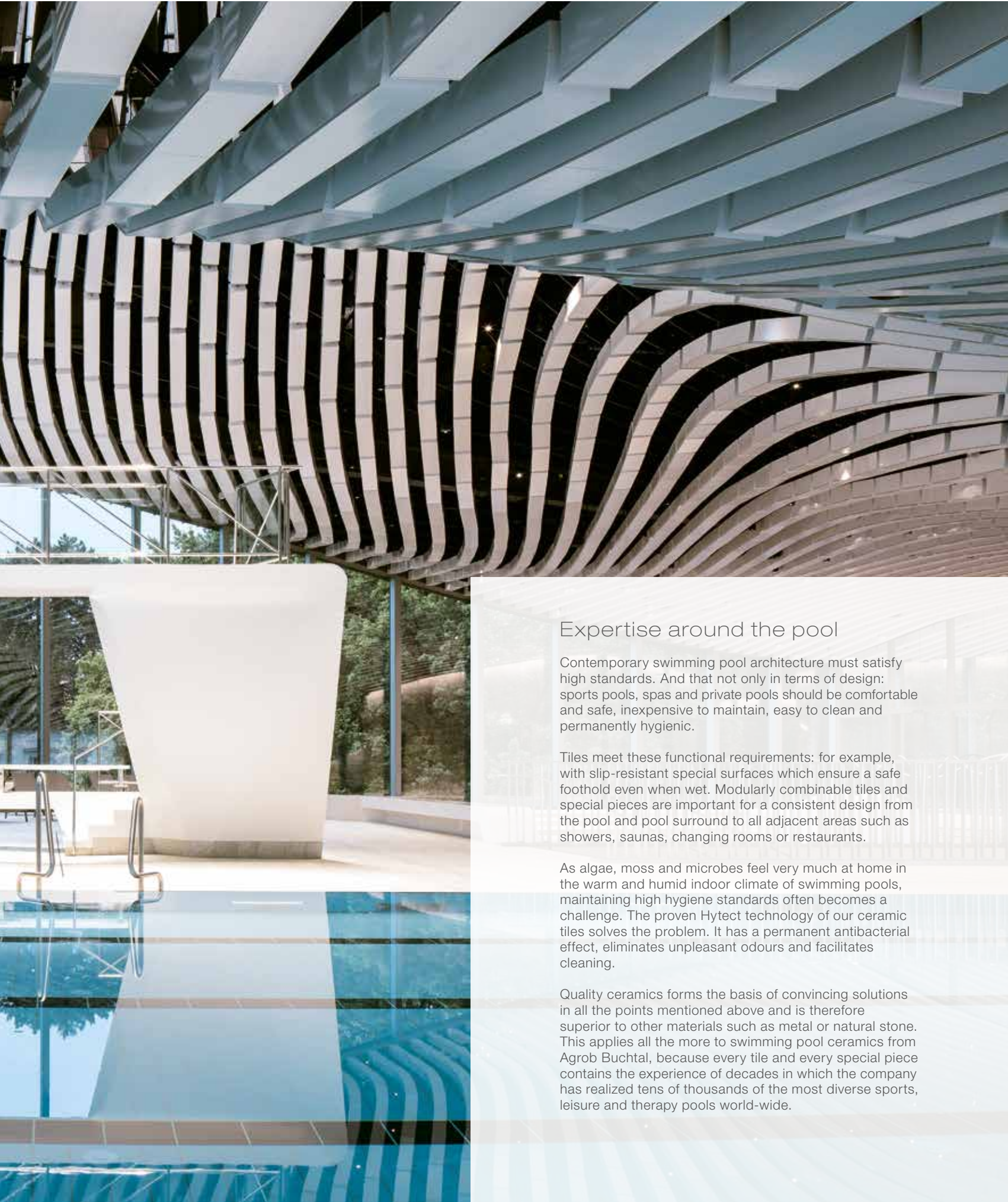

Expertise around the pool

Contemporary swimming pool architecture must satisfy high standards. And that not only in terms of design: sports pools, spas and private pools should be comfortable and safe, inexpensive to maintain, easy to clean and permanently hygienic.

Tiles meet these functional requirements: for example, with slip-resistant special surfaces which ensure a safe foothold even when wet. Modularly combinable tiles and special pieces are important for a consistent design from the pool and pool surround to all adjacent areas such as showers, saunas, changing rooms or restaurants.

As algae, moss and microbes feel very much at home in the warm and humid indoor climate of swimming pools, maintaining high hygiene standards often becomes a challenge. The proven Hytect technology of our ceramic tiles solves the problem. It has a permanent antibacterial effect, eliminates unpleasant odours and facilitates cleaning.

Quality ceramics forms the basis of convincing solutions in all the points mentioned above and is therefore superior to other materials such as metal or natural stone. This applies all the more to swimming pool ceramics from Agrob Buchtal, because every tile and every special piece contains the experience of decades in which the company has realized tens of thousands of the most diverse sports, leisure and therapy pools world-wide.

Pool + Pool surround

Perfect design and functionality.



Sports and competition pools

Project: Duna Aréna / Location: Budapest, Hungary /
Architect: NAPUR Architect Kft / Photo: Péter Molnár / Series: Plural



Open air swimming pools

Project: Aquapark Cikat / Location: Mali Losinji, Croatia /
Architect: Urbing d.o.o. / Photo: Michael Meschede / Series: Chroma



Leisure/adventure pools

Project: Havel-Therme / Location: Werder (Havel), Germany /
Architect: Geising & Böker GmbH Architekten BDA, Hamburg /
Photo: Jochen Stüber / Series: Savona, Plural



School/learners' pools

Project: City of London Freeman's School / Location: London, Great Britain /
Architect: Hawkins Brown Architects LLP / Photo: Jack Hobhouse
photography / Series: Chroma, pool edge system Finland



Thermal/therapeutic baths

Project: Chiemgau Thermen / Location: Bad Endorf, Germany /
 Architect: Architekturwerkstatt Zopf, Salzburg, Austria /
 Photo: Peters Fotodesign, Amerang / Series: Quarzit

Hotel pools

Project: Hotel aja Garmisch-Partenkirchen / Location: Garmisch-Partenkirchen, Germany /
 Architect: SMAP SEEGER MÜLLER Berlin and Korb office, Hamburg /
 Photo: Fotodesign Peters, Amerang / Series: Quarzit, Savona



Private pools

Project: Villa on the Costa Blanca, Spain / Location: Denia, Spain /
 Photo: Marcella Grassi, Barcelona / Series: Quarzit

Convincing arguments in favour of swimming pool ceramics from Agrob Buchtal

- Decades of experience with swimming pool ceramics for highest demands
- Advice regarding application techniques and relief of routine tasks by Agrob Buchtal's in-house planning department
- Hytect technology for easy cleaning, antibacterial effect and elimination of air pollutants
- Accident prevention thanks to graded slip resistance with the GRIP quality seal, absolutely easy to clean
- Greatest design freedom possible thanks to an enormous variety of colors and formats and the possibility of individual special productions
- Special pool edge systems for the most diverse types of use
- Perfectly matched accessories for solutions from one single source
- Cost-effective solutions for all types and sizes of swimming pools
- Maximum resistance of ceramics also in case of saline and sulphate thermal waters

Showers + Changing rooms

Freedom in color, decoration and format



The design of a swimming pool does not end at the pool edge. The aesthetic overall picture includes the consistent design of showers, changing rooms, foyers and also restaurants. There in particular, it is important to be able to freely combine different formats within a color system.

This is possible with the ChromaPlural modular color system. The range extends from mosaics, narrow strip tiles in various lengths to large formats. Rooms and surfaces can thus be scaled, elegantly proportioned and rhythmized. This makes it possible to design wall and floor surfaces across rooms.



Wellness + Spa

Natural wellness landscape
for highest demands



Spas and wellness oases are places of tranquillity and are designed for relaxing body and soul. With sweeping views of landscapes, analogies to pristine elements and natural materials, nature can be transferred to the room. Likewise with organic, original forms. They are reminiscent of soft formations or flowing movements of nature. Like that of water, for example. Smallest mosaic tiles, whether round or square, follow these forms and cover even the smallest curves like a skin.

In addition, the guests expect maximum hygiene and cleanliness in wellness and spa facilities. Ceramic tiles provided with Hytect help operators to achieve this goal in an environmentally friendly way. The surface of Hytect ceramics releases active oxygen naturally in interaction with light. This active oxygen inhibits the growth of mould and bacteria directly on the surface.





Project: Oasia Hotel / Location: Singapore / Architect: WOHA Architects + Patricia Urquiola / Series: Chroma non-slip, Chroma / Photo: Infitude





In its element: Chroma

Especially under water, the demands on the architectural raw material ceramics are great. Chroma bundles all the experience in swimming pool construction in a product series specially designed for underwater use for architects and planners. The standard joint width of 6 mm, which is widely used above all in pool construction, is used.

Stability in the pool: 6 mm joint



Physical stresses lead to high loads in the pool area, which make a specific joint width advisable. The laying of the tiles with a 6 mm joint ensures maximum safety.

Safety without compromises

Accident prevention has the highest priority in every swimming pool - especially in areas with a particularly high risk of slipping, such as stairs leading into the water or walk-through pools. That is why Chroma also offers the slip-resistance classes of category "C". In this way, the highest design and safety requirements can be implemented uniformly and without compromise.

- Chroma
- Chroma non-slip
- Chroma unglazed

COLOR SYSTEM UNICOLOR – A color sphere becomes a sphere of possibilities

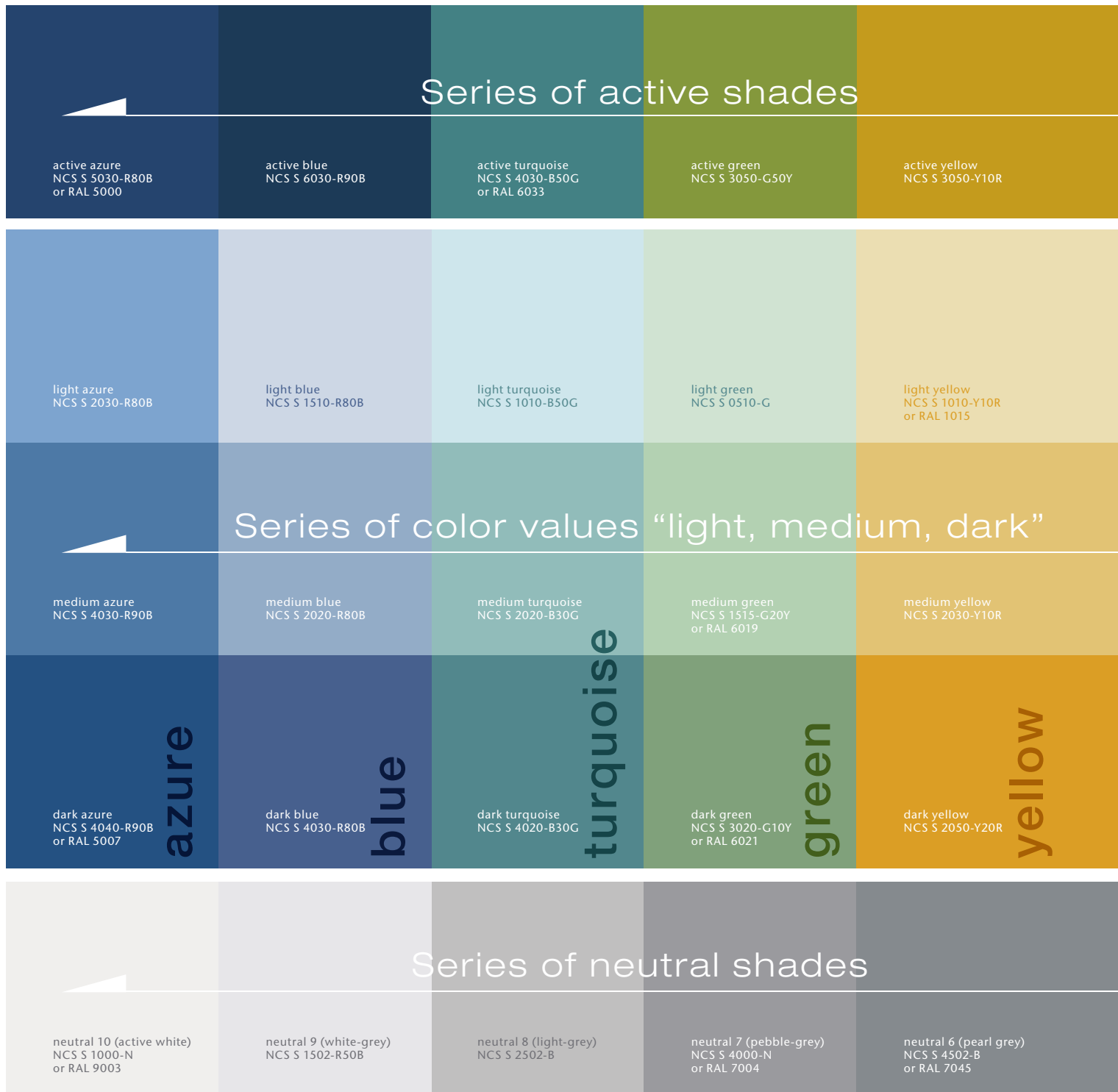

Contrasting colors (glossy)

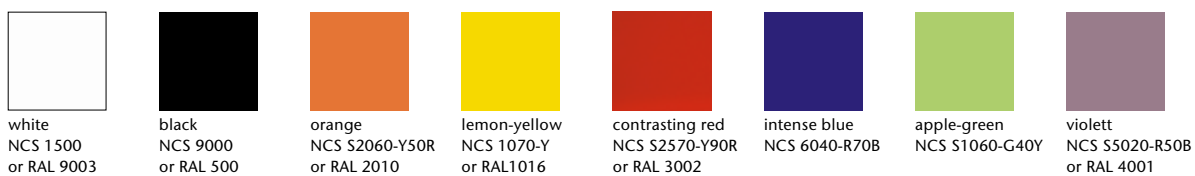

active ochre NCS S 3050-Y40R	active salmon NCS S 4040-Y70R	active oxide red NCS S 4050-Y90R	active stone grey NCS S 5030-Y90R	active sand grey NCS S 7010-Y90R
light ochre NCS S 2030-Y20R	light salmon NCS S 1515-Y50R	light oxide red NCS S 2010-Y80R	light stone grey NCS S 2502-R	light sand grey NCS S 1502-Y
medium ochre NCS S 3030-Y30R	medium salmon NCS S 2020-Y50R	medium oxide red NCS S 3020-Y80R	medium stone grey NCS S 3502-R or RAL 7036	medium sand grey NCS S 3005-Y50R
dark ochre NCS S 4030-Y50R	dark salmon NCS S 3040-Y60R	dark oxide red NCS S 5020-Y80R	dark stone grey NCS S 6005-Y80R	dark sand grey NCS S 6010-Y50R
ochre	salmon	oxide red	stone grey	sand grey
neutral 5 (basalt-grey) NCS S 5502-B or RAL 7046	neutral 4 (graphite-black) NCS S 6000-N or RAL 7037	neutral 3 (asphalt black) NCS S 6500-N	neutral 2 (anthracite) NCS S 7500-N or RAL 7015	neutral 1 (deep black) NCS S 9000-N or RAL 9017

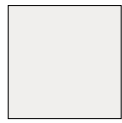

701
neutral 10 (active white)

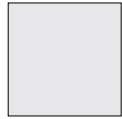

552119
neutral 9 (white-grey)



552118
neutral 8 (light-grey)



552117
neutral 7 (pebble-grey)



552116
neutral 6 (pearl-grey)



552115
neutral 5 (basalt-grey)



552114
neutral 4 (graphite-black)



552113
neutral 3 (asphalt black)



552112
neutral 2 (anthracite)



5716
neutral 1 (deep black)



552004
dark azure



552008
dark blue



552012
dark turquoise



552016
dark green



552020
dark yellow



552024
dark ochre



552028
dark salmon



552032
dark oxide red



552036
dark stone grey



552040
dark sand grey



552003
medium azure



552007
medium blue



552011
medium turquoise



552015
medium green



552019
medium yellow



552023
medium ochre



552027
medium salmon



552031
medium oxide red



552035
medium stone grey



552039
medium sand grey



552002
light azure



552006
light blue



552010
light turquoise



552014
light green



552018
light yellow



552022
light ochre



552026
light salmon



552030
light oxide red



552034
light stone grey



552038
light sand grey



552001
active azure



552005
active blue



552009
active turquoise



552013
active green



552017
active yellow



552021
active ochre



552025
active salmon



552029
active oxide red



552033
active stone grey



552037
active sand grey

Contrasting colors
(glossy)



700
white



717
black



151
orange



150
lemon-yellow



154
contrasting red



144
intense blue



152
apple-green



153
violett



Floor/wall tile
6.2 x 25 cm, 2 1/2 x 10 in

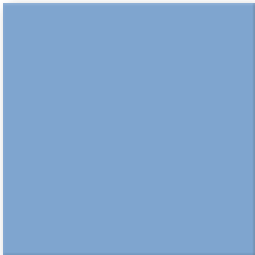

Floor/wall tile
25 x 25 cm, 10 x 10 in



Floor/wall tile
12.5 x 12.5 cm, 5 x 5 in

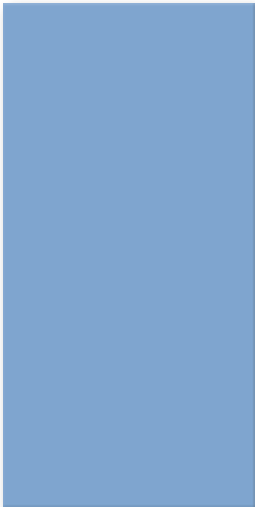

Floor/wall tile
25 x 50 cm, 10 x 20 in



Floor/wall tile
12.5 x 25 cm, 5 x 10 in



Floor/wall tile
12.5 x 50 cm, 5 x 20 in

Floor/Wall Tiles

6.2 x 25 cm^{2/6}



12.5 x 12.5 cm^{2/6}



12.5 x 25 cm²



12.5 x 50 cm¹

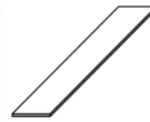

25 x 25 cm²



25 x 50 cm¹

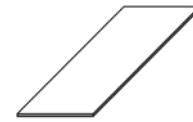

Model number	18210H	12020H	18120H	41550HK	12050H	42550HK
Nom. dim. - cm/in	6.2 x 25 / 2 1/2 x 10	12.5 x 12.5 / 5 x 5	12.5 x 25 / 5 x 10	12.5 x 50 / 5 x 20	25 x 25 / 10 x 10	25 x 50 / 10 x 20
Work size	56 x 244 x 6 mm	119 x 119 x 6 mm	119 x 244 x 6 mm	119 x 494 x 8 mm	244 x 244 x 6 mm	244 x 494 x 8 mm
Surface	smooth, silky-matt ⁵	smooth, silky-matt ⁵	smooth, silky-matt ⁵	smooth, silky-matt ⁵	smooth, silky-matt ⁵	smooth, silky-matt ⁵
m ² - pieces	64.000	64.000	32.000	16.000	16.000	8.000
m ² - kg	10.880	12.160	12.160	17.040	12.800	17.040
Bundle - pieces	88	88	44	8	18	9
Bundle - m ²	1.375	1.375	1.375	0.500	1.125	1.125
Bundle - kg	14.960	16.720	16.720	8.520	14.400	19.170
Pallet - m ²	132.000	115.500	115.500	55.000	91.125	40.500
Pallet - kg	1,436.160	1,404.480	1,404.480	937.200	1,166.400	690.120
Product standard	Alb	Alb	Alb	Alb	Alb	Alb
neutral 10 (active white glossy)	4 700i-18210H Price gr. A157 (m ²)	700i-12020H Price gr. A157 (m ²)	700i-18120H Price gr. A94 (m ²)	700i-41550HK Price gr. A178 (m ²)	700i-12050H Price gr. A157 (m ²)	700i-42550HK Price gr. A157 (m ²)
neutral 10 (active white matt)	4 701i-18210H Price gr. A157 (m ²)	701i-12020H Price gr. A157 (m ²)	701i-18120H Price gr. A94 (m ²)	701i-41550HK Price gr. A178 (m ²)	701i-12050H Price gr. A157 (m ²)	701i-42550HK Price gr. A157 (m ²)
neutral 1 (deep black)	1 5716i-18210H⁴ Price gr. A187 (m ²)	5716i-12020H⁴ Price gr. A208 (m ²)	5716i-18120H⁴ Price gr. A208 (m ²)	5716-41550HK⁴ Price gr. A208 (m ²)	5716i-12050H⁴ Price gr. A187 (m ²)	5716i-42550HK⁴ Price gr. A187 (m ²)
active azure	2 552001-18210H Price gr. A187 (m ²)	552001-12020H Price gr. A187 (m ²)	552001-18120H Price gr. A121 (m ²)	552001-41550HK Price gr. A208 (m ²)	552001-12050H Price gr. A187 (m ²)	552001-42550HK Price gr. A187 (m ²)
light azure	4 552002-18210H Price gr. A187 (m ²)	552002-12020H Price gr. A187 (m ²)	552002-18120H Price gr. A121 (m ²)	552002-41550HK Price gr. A208 (m ²)	552002-12050H Price gr. A187 (m ²)	552002-42550HK Price gr. A187 (m ²)
medium azure	3 552003-18210H Price gr. A187 (m ²)	552003-12020H Price gr. A187 (m ²)	552003-18120H Price gr. A121 (m ²)	552003-41550HK³ Price gr. A235 (m ²)	552003-12050H Price gr. A187 (m ²)	552003-42550HK Price gr. A187 (m ²)
dark azure	2 552004-18210H Price gr. A187 (m ²)	552004-12020H Price gr. A187 (m ²)	552004-18120H Price gr. A121 (m ²)	552004-41550HK³ Price gr. A235 (m ²)	552004-12050H³ Price gr. A217 (m ²)	552004-42550HK³ Price gr. A217 (m ²)
active blue	2 552005-18210H³ Price gr. A217 (m ²)	552005-12020H Price gr. A187 (m ²)	552005-18120H Price gr. A121 (m ²)	552005-41550HK³ Price gr. A235 (m ²)	552005-12050H Price gr. A187 (m ²)	552005-42550HK³ Price gr. A217 (m ²)
light blue	4 552006-18210H³ Price gr. A217 (m ²)	552006-12020H Price gr. A187 (m ²)	552006-18120H Price gr. A121 (m ²)	552006-41550HK³ Price gr. A235 (m ²)	552006-12050H Price gr. A187 (m ²)	552006-42550HK Price gr. A187 (m ²)
medium blue	3 552007-18210H Price gr. A187 (m ²)	552007-12020H Price gr. A187 (m ²)	552007-18120H Price gr. A121 (m ²)	552007-41550HK³ Price gr. A235 (m ²)	552007-12050H Price gr. A187 (m ²)	552007-42550HK Price gr. A187 (m ²)
dark blue	2 552008-18210H Price gr. A187 (m ²)	552008-12020H³ Price gr. A217 (m ²)	552008-18120H Price gr. A121 (m ²)	552008-41550HK³ Price gr. A235 (m ²)	552008-12050H³ Price gr. A217 (m ²)	552008-42550HK³ Price gr. A217 (m ²)
active turquoise	2 552009-18210H Price gr. A187 (m ²)	552009-12020H³ Price gr. A217 (m ²)	552009-18120H Price gr. A121 (m ²)	552009-41550HK³ Price gr. A235 (m ²)	552009-12050H³ Price gr. A217 (m ²)	552009-42550HK³ Price gr. A217 (m ²)
light turquoise	4 552010-18210H Price gr. A187 (m ²)	552010-12020H Price gr. A187 (m ²)	552010-18120H Price gr. A121 (m ²)	552010-41550HK³ Price gr. A235 (m ²)	552010-12050H³ Price gr. A217 (m ²)	552010-42550HK³ Price gr. A217 (m ²)
medium turquoise	3 552011-18210H Price gr. A187 (m ²)	552011-12020H Price gr. A187 (m ²)	552011-18120H Price gr. A121 (m ²)	552011-41550HK³ Price gr. A235 (m ²)	552011-12050H Price gr. A187 (m ²)	552011-42550HK³ Price gr. A217 (m ²)
dark turquoise	2 552012-18210H⁴ Price gr. A187 (m ²)	552012-12020H⁴ Price gr. A187 (m ²)	552012-18120H⁴ Price gr. A121 (m ²)	552012-41550HK^{3/4} Price gr. A235 (m ²)	552012-12050H^{3/4} Price gr. A217 (m ²)	552012-42550HK^{3/4} Price gr. A217 (m ²)
active green	2 552013-18210H Price gr. A187 (m ²)	552013-12020H Price gr. A187 (m ²)	552013-18120H Price gr. A121 (m ²)	552013-41550HK³ Price gr. A235 (m ²)	552013-12050H³ Price gr. A217 (m ²)	552013-42550HK³ Price gr. A217 (m ²)
light green	4 552014-18210H Price gr. A187 (m ²)	552014-12020H Price gr. A187 (m ²)	552014-18120H Price gr. A121 (m ²)	552014-41550HK³ Price gr. A235 (m ²)	552014-12050H Price gr. A187 (m ²)	552014-42550HK³ Price gr. A217 (m ²)
medium green	3 552015-18210H Price gr. A187 (m ²)	552015-12020H Price gr. A187 (m ²)	552015-18120H Price gr. A121 (m ²)	552015-41550HK³ Price gr. A235 (m ²)	552015-12050H Price gr. A187 (m ²)	552015-42550HK Price gr. A187 (m ²)
dark green	2 552016-18210H Price gr. A187 (m ²)	552016-12020H Price gr. A187 (m ²)	552016-18120H Price gr. A121 (m ²)	552016-41550HK³ Price gr. A235 (m ²)	552016-12050H Price gr. A187 (m ²)	552016-42550HK³ Price gr. A217 (m ²)
active yellow	2 552017-18210H^{3/4} Price gr. A217 (m ²)	552017-12020H^{3/4} Price gr. A217 (m ²)	552017-18120H⁴ Price gr. A121 (m ²)	552017-41550HK^{3/4} Price gr. A235 (m ²)	552017-12050H^{3/4} Price gr. A217 (m ²)	552017-42550HK^{3/4} Price gr. A217 (m ²)
light yellow	4 552018-18210H³ Price gr. A217 (m ²)	552018-12020H Price gr. A187 (m ²)	552018-18120H Price gr. A121 (m ²)	552018-41550HK³ Price gr. A235 (m ²)	552018-12050H Price gr. A187 (m ²)	552018-42550HK Price gr. A187 (m ²)
medium yellow	3 552019-18210H Price gr. A187 (m ²)	552019-12020H Price gr. A187 (m ²)	552019-18120H Price gr. A121 (m ²)	552019-41550HK³ Price gr. A235 (m ²)	552019-12050H Price gr. A187 (m ²)	552019-42550HK³ Price gr. A217 (m ²)
dark yellow	2 552020-18210H⁴ Price gr. A187 (m ²)	552020-12020H^{3/4} Price gr. A217 (m ²)	552020-18120H⁴ Price gr. A121 (m ²)	552020-41550HK^{3/4} Price gr. A235 (m ²)	552020-12050H^{3/4} Price gr. A217 (m ²)	552020-42550HK^{3/4} Price gr. A217 (m ²)



rectified

² **Overglazed edges / corners refer to page 347**

³ **Make-to-order production: return and/or cancellation of ordered products not possible.**



⁴ **Color deviations from the standard due to production reasons are possible.**

⁵ **Exception: active white glossy: smooth, glossy**

⁶ **Supplied as double-tiles; to be broken by customer**

All products: Color Shade Variation V0

Floor/Wall Tiles

6.2 x 25 cm^{2/5}



12.5 x 12.5 cm^{2/5}



12.5 x 25 cm²



12.5 x 50 cm¹

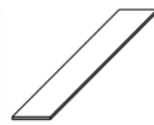

25 x 25 cm²



25 x 50 cm¹

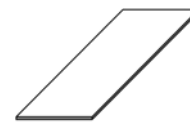

	18210H	12020H	18120H	41550HK	12050H	42550HK	Model number
	6.2 x 25 / 2 1/2 x 10	12.5 x 12.5 / 5 x 5	12.5 x 25 / 5 x 10	12.5 x 50 / 5 x 20	25 x 25 / 10 x 10	25 x 50 / 10 x 20	Nom. dim. - cm/in
	56 x 244 x 6 mm	119 x 119 x 6 mm	119 x 244 x 6 mm	119 x 494 x 8 mm	244 x 244 x 6 mm	244 x 494 x 8 mm	Work size
	smooth, silky-matt	smooth, silky-matt	smooth, silky-matt	smooth, silky-matt	smooth, silky-matt	smooth, silky-matt	Surface
	64.000	64.000	32.000	16.000	16.000	8.000	m ² - pieces
	10.880	12.160	12.160	17.040	12.800	17.040	m ² - kg
	88	88	44	8	18	9	Bundle - pieces
	1.375	1.375	1.375	0.500	1.125	1.125	Bundle - m ²
	14.960	16.720	16.720	8.520	14.400	19.170	Bundle - kg
	132.000	115.500	115.500	55.000	91.125	40.500	Pallet - m ²
	1,436.160	1,404.480	1,404.480	937.200	1,166.400	690.120	Pallet - kg
	Alb	Alb	Alb	Alb	Alb	Alb	Product standard
	552021-18210H^{3/4} Price gr. A217 (m ²)	552021-12020H^{3/4} Price gr. A217 (m ²)	552021-18120H^{3/4} Price gr. A151 (m ²)	552021-41550HK^{3/4} Price gr. A235 (m ²)	552021-12050H^{3/4} Price gr. A217 (m ²)	552021-42550HK^{3/4} Price gr. A217 (m ²)	2
	552022-18210H Price gr. A187 (m ²)	552022-12020H³ Price gr. A217 (m ²)	552022-18120H³ Price gr. A151 (m ²)	552022-41550HK³ Price gr. A235 (m ²)	552022-12050H³ Price gr. A217 (m ²)	552022-42550HK³ Price gr. A217 (m ²)	4
	552023-18210H³ Price gr. A217 (m ²)	552023-12020H³ Price gr. A217 (m ²)	552023-18120H Price gr. A121 (m ²)	552023-41550HK³ Price gr. A235 (m ²)	552023-12050H³ Price gr. A217 (m ²)	552023-42550HK³ Price gr. A217 (m ²)	3
	552024-18210H³ Price gr. A217 (m ²)	552024-12020H³ Price gr. A217 (m ²)	552024-18120H Price gr. A121 (m ²)	552024-41550HK³ Price gr. A235 (m ²)	552024-12050H³ Price gr. A217 (m ²)	552024-42550HK³ Price gr. A217 (m ²)	2
	552025-18210H⁴ Price gr. A187 (m ²)	552025-12020H^{3/4} Price gr. A217 (m ²)	552025-18120H^{3/4} Price gr. A151 (m ²)	552025-41550HK^{3/4} Price gr. A235 (m ²)	552025-12050H^{3/4} Price gr. A217 (m ²)	552025-42550HK^{3/4} Price gr. A217 (m ²)	2
	552026-18210H Price gr. A187 (m ²)	552026-12020H³ Price gr. A217 (m ²)	552026-18120H Price gr. A121 (m ²)	552026-41550HK³ Price gr. A235 (m ²)	552026-12050H³ Price gr. A217 (m ²)	552026-42550HK³ Price gr. A217 (m ²)	4
	552027-18210H Price gr. A187 (m ²)	552027-12020H³ Price gr. A217 (m ²)	552027-18120H³ Price gr. A151 (m ²)	552027-41550HK³ Price gr. A235 (m ²)	552027-12050H Price gr. A187 (m ²)	552027-42550HK³ Price gr. A217 (m ²)	3
	552028-18210H³ Price gr. A217 (m ²)	552028-12020H³ Price gr. A217 (m ²)	552028-18120H³ Price gr. A151 (m ²)	552028-41550HK³ Price gr. A235 (m ²)	552028-12050H³ Price gr. A217 (m ²)	552028-42550HK³ Price gr. A217 (m ²)	2
	552029-18210H Price gr. A187 (m ²)	552029-12020H³ Price gr. A217 (m ²)	552029-18120H Price gr. A121 (m ²)	552029-41550HK³ Price gr. A235 (m ²)	552029-12050H Price gr. A187 (m ²)	552029-42550HK³ Price gr. A217 (m ²)	2
	552030-18210H³ Price gr. A217 (m ²)	552030-12020H³ Price gr. A217 (m ²)	552030-18120H³ Price gr. A151 (m ²)	552030-41550HK³ Price gr. A235 (m ²)	552030-12050H Price gr. A187 (m ²)	552030-42550HK³ Price gr. A217 (m ²)	4
	552031-18210H Price gr. A187 (m ²)	552031-12020H³ Price gr. A217 (m ²)	552031-18120H³ Price gr. A151 (m ²)	552031-41550HK³ Price gr. A235 (m ²)	552031-12050H Price gr. A187 (m ²)	552031-42550HK³ Price gr. A217 (m ²)	3
	552032-18210H Price gr. A217 (m ²)	552032-12020H³ Price gr. A217 (m ²)	552032-18120H Price gr. A121 (m ²)	552032-41550HK³ Price gr. A235 (m ²)	552032-12050H³ Price gr. A217 (m ²)	552032-42550HK³ Price gr. A217 (m ²)	2
	552033-18210H Price gr. A187 (m ²)	552033-12020H³ Price gr. A217 (m ²)	552033-18120H Price gr. A121 (m ²)	552033-41550HK³ Price gr. A235 (m ²)	552033-12050H³ Price gr. A217 (m ²)	552033-42550HK³ Price gr. A217 (m ²)	2
	552034-18210H³ Price gr. A217 (m ²)	552034-12020H³ Price gr. A217 (m ²)	552034-18120H³ Price gr. A151 (m ²)	552034-41550HK³ Price gr. A235 (m ²)	552034-12050H³ Price gr. A217 (m ²)	552034-42550HK³ Price gr. A217 (m ²)	4
	552035-18210H Price gr. A187 (m ²)	552035-12020H Price gr. A187 (m ²)	552035-18120H Price gr. A121 (m ²)	552035-41550HK³ Price gr. A235 (m ²)	552035-12050H³ Price gr. A217 (m ²)	552035-42550HK³ Price gr. A217 (m ²)	3
	552036-18210H³ Price gr. A217 (m ²)	552036-12020H³ Price gr. A217 (m ²)	552036-18120H Price gr. A121 (m ²)	552036-41550HK³ Price gr. A235 (m ²)	552036-12050H³ Price gr. A217 (m ²)	552036-42550HK³ Price gr. A217 (m ²)	2
	552037-18210H³ Price gr. A217 (m ²)	552037-12020H³ Price gr. A217 (m ²)	552037-18120H Price gr. A121 (m ²)	552037-41550HK³ Price gr. A235 (m ²)	552037-12050H³ Price gr. A217 (m ²)	552037-42550HK³ Price gr. A217 (m ²)	2
	552038-18210H Price gr. A187 (m ²)	552038-12020H Price gr. A187 (m ²)	552038-18120H Price gr. A121 (m ²)	552038-41550HK³ Price gr. A235 (m ²)	552038-12050H Price gr. A187 (m ²)	552038-42550HK³ Price gr. A217 (m ²)	4
	552039-18210H³ Price gr. A217 (m ²)	552039-12020H³ Price gr. A217 (m ²)	552039-18120H Price gr. A121 (m ²)	552039-41550HK³ Price gr. A235 (m ²)	552039-12050H³ Price gr. A217 (m ²)	552039-42550HK³ Price gr. A217 (m ²)	3
	552040-18210H³ Price gr. A217 (m ²)	552040-12020H³ Price gr. A217 (m ²)	552040-18120H Price gr. A121 (m ²)	552040-41550HK³ Price gr. A235 (m ²)	552040-12050H³ Price gr. A217 (m ²)	552040-42550HK Price gr. A187 (m ²)	2
	552119-18210H³ Price gr. A217 (m ²)	552119-12020H³ Price gr. A217 (m ²)	552119-18120H Price gr. A121 (m ²)	552119-41550HK³ Price gr. A235 (m ²)	552119-12050H³ Price gr. A217 (m ²)	552119-42550HK³ Price gr. A217 (m ²)	4
	552118-18210H Price gr. A187 (m ²)	552118-12020H³ Price gr. A217 (m ²)	552118-18120H Price gr. A121 (m ²)	552118-41550HK³ Price gr. A235 (m ²)	552118-12050H³ Price gr. A217 (m ²)	552118-42550HK³ Price gr. A217 (m ²)	4
	552117-18210H Price gr. A187 (m ²)	552117-12020H³ Price gr. A217 (m ²)	552117-18120H Price gr. A121 (m ²)	552117-41550HK³ Price gr. A235 (m ²)	552117-12050H Price gr. A187 (m ²)	552117-42550HK³ Price gr. A217 (m ²)	4
							neutral 9 (white grey)
							neutral 8 (light grey)
							neutral 7 (pebble grey)



² Overglazed edges / corners refer to page 347

³ Make-to-order production: return and/or cancellation of ordered products not possible.

⁴ Color deviations from the standard due to production reasons are possible.

⁵ Supplied as double-tiles; to be broken by customer

All products: Color Shade Variation V0



Floor/Wall Tiles

6.2 x 25 cm^{2/7}



12.5 x 12.5 cm^{2/7}



12.5 x 25 cm²



12.5 x 50 cm¹

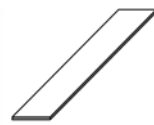

25 x 25 cm²



25 x 50 cm¹

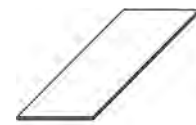

Model number	18210H	12020H	18120H	41550HK	12050H	42550HK	
Nom. dim. - cm/in	6.2 x 25 / 2 1/2 x 10	12.5 x 12.5 / 5 x 5	12.5 x 25 / 5 x 10	12.5 x 50 / 5 x 20	25 x 25 / 10 x 10	25 x 50 / 10 x 20	
Work size	56 x 244 x 6 mm	119 x 119 x 6 mm	119 x 244 x 6 mm	119 x 494 x 8 mm	244 x 244 x 6 mm	244 x 494 x 8 mm	
Surface	smooth, silky-matt ⁶	smooth, silky-matt ⁶	smooth, silky-matt ⁶	smooth, silky-matt ⁶	smooth, silky-matt ⁶	smooth, silky-matt ⁶	
m ² - pieces	64.000	64.000	32.000	16.000	16.000	8.000	
m ² - kg	10.880	12.160	12.160	17.040	12.800	17.040	
Bundle - pieces	88	88	44	8	18	9	
Bundle - m ²	1.375	1.375	1.375	0.500	1.125	1.125	
Bundle - kg	14.960	16.720	16.720	8.520	14.400	19.170	
Pallet - m ²	132.000	115.500	115.500	55.000	91.125	40.500	
Pallet - kg	1,436.160	1,404.480	1,404.480	937.200	1,166.400	690.120	
Product standard	Alb	Alb	Alb	Alb	Alb	Alb	
neutral 6 (pearl grey)	3 552116-18210H ³ Price gr. A217 (m ²)	552116-12020H ³ Price gr. A217 (m ²)	552116-18120H Price gr. A121 (m ²)	552116-41550HK ³ Price gr. A235 (m ²)	552116-12050H ³ Price gr. A217 (m ²)	552116-42550HK ³ Price gr. A217 (m ²)	
neutral 5 (basalt-grey)	3 552115-18210H ³ Price gr. A217 (m ²)	552115-12020H ³ Price gr. A217 (m ²)	552115-18120H ³ Price gr. A151 (m ²)	552115-41550HK ³ Price gr. A235 (m ²)	552115-12050H ³ Price gr. A217 (m ²)	552115-42550HK ³ Price gr. A217 (m ²)	
neutral 4 (graphite black)	3 552114-18210H ^{3/4} Price gr. A217 (m ²)	552114-12020H ^{3/4} Price gr. A217 (m ²)	552114-18120H ^{3/4} Price gr. A151 (m ²)	552114-41550HK ^{3/4} Price gr. A235 (m ²)	552114-12050H ^{3/4} Price gr. A217 (m ²)	552114-42550HK⁴ Price gr. A187 (m ²)	
neutral 3 (asphalt black)	3 552113-18210H ³ Price gr. A217 (m ²)	552113-12020H ³ Price gr. A217 (m ²)	552113-18120H Price gr. A121 (m ²)	552113-41550HK ³ Price gr. A235 (m ²)	552113-12050H ³ Price gr. A217 (m ²)	552113-42550HK ³ Price gr. A217 (m ²)	
neutral 2 (anthracite)	2 552112-18210H Price gr. A187 (m ²)	552112-12020H ³ Price gr. A217 (m ²)	552112-18120H Price gr. A121 (m ²)	552112-41550HK ³ Price gr. A235 (m ²)	552112-12050H Price gr. A187 (m ²)	552112-42550HK Price gr. A187 (m ²)	
black, glossy	1 717i-18210H ³ Price gr. A217 (m ²)	717i-12020H ³ Price gr. A217 (m ²)	717i-18120H ³ Price gr. A151 (m ²)	717i-41550HK ³ Price gr. A235 (m ²)	717i-12050H ³ Price gr. A217 (m ²)	717i-42550HK ³ Price gr. A217 (m ²)	
orange, glossy	1 151i-18210H ³ Price gr. A217 (m ²)	151i-12020H ³ Price gr. A217 (m ²)	151i-18120H ³ Price gr. A151 (m ²)	151i-41550HK ³ Price gr. A235 (m ²)	151i-12050H ³ Price gr. A217 (m ²)	151i-42550HK ³ Price gr. A217 (m ²)	
lemon-yellow glossy	2 150i-18210H ³ Price gr. A217 (m ²)	150i-12020H ³ Price gr. A217 (m ²)	150i-18120H ³ Price gr. A151 (m ²)	150i-41550HK ³ Price gr. A235 (m ²)	150i-12050H ³ Price gr. A217 (m ²)	150i-42550HK ³ Price gr. A217 (m ²)	
contrasting red glossy	1 154i-18210H ³ Price gr. A217 (m ²)	154i-12020H ³ Price gr. A217 (m ²)	154i-18120H ³ Price gr. A151 (m ²)	154i-41550HK ³ Price gr. A235 (m ²)	154i-12050H ³ Price gr. A217 (m ²)	154i-42550HK ³ Price gr. A217 (m ²)	
intense blue glossy	1 144-18210 ^{3/5} Price gr. A217 (m ²)	144-12020 ^{3/5} Price gr. A217 (m ²)	144-18120 ^{3/5} Price gr. A151 (m ²)	144-41550K ^{3/5} Price gr. A235 (m ²)	144-12050 ^{3/5} Price gr. A217 (m ²)	144-42550K ^{3/5} Price gr. A217 (m ²)	
apple-green, glossy	2 152i-18210H ³ Price gr. A217 (m ²)	152i-12020H ³ Price gr. A217 (m ²)	152i-18120H ³ Price gr. A151 (m ²)	152i-41550HK ³ Price gr. A235 (m ²)	152i-12050H ³ Price gr. A217 (m ²)	152i-42550HK ³ Price gr. A217 (m ²)	
violet, glossy	1 153i-18210H ³ Price gr. A217 (m ²)	153i-12020H ³ Price gr. A217 (m ²)	153i-18120H ³ Price gr. A151 (m ²)	153i-41550HK ³ Price gr. A235 (m ²)	153i-12050H ³ Price gr. A217 (m ²)	153i-42550HK ³ Price gr. A217 (m ²)	



¹ rectified

² Overglazed edges / corners refer to page 347



³ Make-to-order production: return and/or cancellation of ordered products not possible.

⁴ Production-related color deviations from the standard are possible.

⁵ without Hytect coating

⁶ Exception: contrasting colors black, orange, lemon-yellow, contrasting red, intense blue, apple-green, violet: smooth, glossy

⁷ Supplied as double-tiles; to be broken by customer

All products: Color Shade Variation V0

Overglazed edges/corners^{1/2} Floor/Wall Tiles

6.2 x 25 cm



6.2 x 25 cm



12.5 x 12.5 cm



12.5 x 25 cm



12.5 x 25 cm



25 x 25 cm



overglazed
corner left

overglazed
corner right

overglazed
corner left

overglazed
corner left

overglazed
corner right

overglazed
corner left

	18213H	18214H	12023H	18123H	18124H	12053H	Stress group	Model number
	6.2 x 25 / 2 1/2 x 10	6.2 x 25 / 2 1/2 x 10	12.5 x 12.5 / 5 x 5	12.5 x 25 / 5 x 10	12.5 x 25 / 5 x 10	25 x 25 / 10 x 10		
	56 x 244 x 6 mm	56 x 244 x 6 mm	119 x 119 x 6 mm	119 x 244 x 6 mm	119 x 244 x 6 mm	244 x 244 x 6 mm		Work size
	smooth, silky-matt ⁴	smooth, silky-matt ⁴	smooth, silky-matt ⁴	smooth, silky-matt ⁴	smooth, silky-matt ⁴	smooth, silky-matt ⁴		Surface
	64.000	64.000	64.000	32.000	32.000	16.000		m ² - pieces
	10.880	10.880	12.160	12.160	12.160	12.800		m ² - kg
	88	88	88	44	44	18		Bundle - pieces
	1.375	1.375	1.375	1.375	1.375	1.125		Bundle - m ²
	14.960	14.960	16.720	16.720	16.720	14.400		Bundle - kg
	132.000	132.000	115.500	115.500	115.500	91.125		Pallet - m ²
	1,436.160	1,436.160	1,404.480	1,404.480	1,404.480	1,166.400		Pallet - kg
	Alb	Alb	Alb	Alb	Alb	Alb		Product standard
	700i-18213H	700i-18214H	700i-12023H	700i-18123H	700i-18124H	700i-12053H	4	neutral 10
	Price gr. A157 (m ²)	Price gr. A157 (m ²)	Price gr. A157 (m ²)	Price gr. A109 (m ²)	Price gr. A109 (m ²)	Price gr. A157 (m ²)		(active white glossy)
	701i-18213H	701i-18214H	701i-12023H	701i-18123H	701i-18124H	701i-12053H	4	neutral 10
	Price gr. A157 (m ²)	Price gr. A157 (m ²)	Price gr. A157 (m ²)	Price gr. A109 (m ²)	Price gr. A109 (m ²)	Price gr. A157 (m ²)		(active white matt)
	5716i-18213H ³	5716i-18214H ³	5716i-12023H ³	5716i-18123H ³	5716i-18124H ³	5716i-12053H ³	1	neutral 1
	Price gr. A187 (m ²)	Price gr. A187 (m ²)	Price gr. A187 (m ²)	Price gr. A136 (m ²)	Price gr. A136 (m ²)	Price gr. A187 (m ²)		(deep black)
	552001-18213H	552001-18214H	552001-12023H	552001-18123H	552001-18124H	552001-12053H	2	active azure
	Price gr. A187 (m ²)	Price gr. A187 (m ²)	Price gr. A187 (m ²)	Price gr. A136 (m ²)	Price gr. A136 (m ²)	Price gr. A187 (m ²)		
	552002-18213H	552002-18214H	552002-12023H	552002-18123H	552002-18124H	552002-12053H	4	light azure
	Price gr. A187 (m ²)	Price gr. A187 (m ²)	Price gr. A187 (m ²)	Price gr. A136 (m ²)	Price gr. A136 (m ²)	Price gr. A187 (m ²)		

¹ Other colors available on request

²  Make-to-order production: return and/or cancellation of ordered products not possible.

³ Production-related color deviations from the standard are possible.

⁴ Exception: active white glossy: smooth, glossy

All products: Color Shade Variation V0



Overglazed edges
available on request:



Replace last figure 0 of
standard model no. by ...

... 3 = corner left

... 4 = corner right

overglazed edges

Example: Standard model no. 18120 = 119 x 244 x 6 mm,
Model no. 18123 = overglazed corner left

Slip resistance „B“

-/B



91 white / neutral 10 (active white)



553119 neutral 9 (white-grey)



553118 neutral 8 (light-grey)



553117 neutral 7 (pebble-grey)



553116 neutral 6 (pearl grey)



553115 neutral 5 (basalt grey)



553114 neutral 4 (graphite-black)



553113 neutral 3 (asphalt black)



553112 neutral 2 (anthracite)



340 black / neutral 1 (deep black)

-/B



553004 dark azure



553008 dark blue



553016 dark green



553023 medium ochre



553036 dark stone grey



553040 dark sand grey



553003 medium azure



553007 medium blue



553011 medium turquoise



553016 medium green



553019 medium yellow



553027 medium salmon



553031 medium oxide red



553035 medium stone grey



553039 medium sand grey



553002 light azure

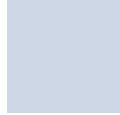

553006 light blue



553010 light turquoise



553014 light green



553018 light yellow



553026 light salmon



553034 light stone grey

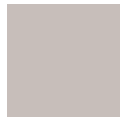

553038 light sand grey

-/B



553001 active azure



553033 active stone grey



553037 active sand grey

-/B



77 contrasting red



Floor tile
12.5 x 12.5 cm, 5 x 5 in



Floor tile
12.5 x 25 cm, 5 x 10 in



Floor tile
25 x 25 cm, 10 x 10 in

On request, other colors of the series Chroma are also available as non-slip glazes with a joint width of 6 mm.

Slip resistance „B“

Floor Tiles²

12.5 x 12.5 cm³



12.5 x 25 cm



25 x 25 cm



				32020H	38110H	32050H	Model number
				12.5 x 12.5 / 5 x 5	12.5 x 25 / 5 x 10	25 x 25 / 10 x 10	Nom. dim. - cm/in
				119 x 119 x 8 mm	119 x 244 x 8 mm	244 x 244 x 8 mm	Work size
				smooth, silky-matt	smooth, silky-matt	smooth, silky-matt	Surface
				64.000	32.000	16.000	m ² - pieces
				15.360	15.680	16.960	m ² - kg
				66	33	14	Bundle - pieces
				1.031	1.031	0.875	Bundle - m ²
				15.840	16.170	14.840	Bundle - kg
				86.625	86.625	70.875	Pallet - m ²
				1,330.560	1,358.280	1,202.040	Pallet - kg
				Alb	Alb	Alb	Product standard
				-/B	-/B	-/B	Slip resistance
				2	2	2	Stress group
				91i-32020H	91i-38110H	91i-32050H	neutral 10
				Price gr. A217 (m ²)	Price gr. A199 (m ²)	Price gr. A217 (m ²)	(active white)
				340i-32020H	340i-38110H	340i-32050H	neutral 1
				Price gr. A217 (m ²)	Price gr. A199 (m ²)	Price gr. A217 (m ²)	(deep black)
				553001-32020H	553001-38110H	553001-32050H	active azure
				Price gr. A217 (m ²)	Price gr. A199 (m ²)	Price gr. A217 (m ²)	
				553002-32020H	553002-38110H	553002-32050H	light azure
				Price gr. A217 (m ²)	Price gr. A199 (m ²)	Price gr. A217 (m ²)	
				553003-32020H	553003-38110H	553003-32050H	medium azure
				Price gr. A217 (m ²)	Price gr. A199 (m ²)	Price gr. A217 (m ²)	
				553004-32020H	553004-38110H	553004-32050H	dark azure
				Price gr. A217 (m ²)	Price gr. A199 (m ²)	Price gr. A217 (m ²)	
				553006-32020H	553006-38110H	553006-32050H	light blue
				Price gr. A217 (m ²)	Price gr. A199 (m ²)	Price gr. A217 (m ²)	
				553007-32020H	553007-38110H	553007-32050H	medium blue
				Price gr. A217 (m ²)	Price gr. A199 (m ²)	Price gr. A217 (m ²)	
				553008-32020H	<i>553008-38110H¹</i>	<i>553008-32050H¹</i>	dark blue
				Price gr. A217 (m ²)	Price gr. A199 (m ²)	Price gr. A217 (m ²)	
				553010-32020H	553010-38110H	<i>553010-32050H¹</i>	light turquoise
				Price gr. A217 (m ²)	Price gr. A199 (m ²)	Price gr. A217 (m ²)	
				553011-32020H	553011-38110H	553011-32050H	medium turquoise
				Price gr. A217 (m ²)	Price gr. A199 (m ²)	Price gr. A217 (m ²)	
				553014-32020H	<i>553014-38110H¹</i>	<i>553014-32050H¹</i>	light green
				Price gr. A217 (m ²)	Price gr. A199 (m ²)	Price gr. A217 (m ²)	
				553015-32020H	553015-38110H	553015-32050H	medium green
				Price gr. A217 (m ²)	Price gr. A199 (m ²)	Price gr. A217 (m ²)	
				553016-32020H	553016-38110H	553016-32050H	dark green
				Price gr. A217 (m ²)	Price gr. A199 (m ²)	Price gr. A217 (m ²)	
				<i>553018-32020H¹</i>	<i>553018-38110H¹</i>	<i>553018-32050H¹</i>	light yellow
				Price gr. A217 (m ²)	Price gr. A199 (m ²)	Price gr. A217 (m ²)	
				553019-32020H	553019-38110H	553019-32050H	medium yellow
				Price gr. A217 (m ²)	Price gr. A199 (m ²)	Price gr. A217 (m ²)	
				<i>553023-32020H¹</i>	553023-38110H	553023-32050H	medium ochre
				Price gr. A217 (m ²)	Price gr. A199 (m ²)	Price gr. A217 (m ²)	
				<i>553026-32020H¹</i>	<i>553026-38110H¹</i>	<i>553026-32050H¹</i>	light salmon
				Price gr. A217 (m ²)	Price gr. A199 (m ²)	Price gr. A217 (m ²)	
				<i>553027-32020H¹</i>	553027-38110H	553027-32050H	medium salmon
				Price gr. A217 (m ²)	Price gr. A199 (m ²)	Price gr. A217 (m ²)	
				553031-32020H	<i>553031-38110H¹</i>	<i>553031-32050H¹</i>	medium oxide red
				Price gr. A217 (m ²)	Price gr. A199 (m ²)	Price gr. A217 (m ²)	
				<i>553033-32020H¹</i>	<i>553033-38110H¹</i>	<i>553033-32050H¹</i>	active stone grey
				Price gr. A217 (m ²)	Price gr. A199 (m ²)	Price gr. A217 (m ²)	
				553034-32020H	<i>553034-38110H¹</i>	<i>553034-32050H¹</i>	light stone grey
				Price gr. A217 (m ²)	Price gr. A199 (m ²)	Price gr. A217 (m ²)	
				553035-32020H	553035-38110H	<i>553035-32050H¹</i>	medium stone grey
				Price gr. A217 (m ²)	Price gr. A199 (m ²)	Price gr. A217 (m ²)	
				553036-32020H	553036-38110H	<i>553036-32050H¹</i>	dark stone grey
				Price gr. A217 (m ²)	Price gr. A199 (m ²)	Price gr. A217 (m ²)	

¹ Make-to-order production: return and/or cancellation of ordered products not possible.



² Rounded edges / corners refer to page 351

³ Supplied as double-tiles; to be broken by customer

All products: Color Shade Variation V0

Slip resistance „B“

Floor Tiles²

12.5 x 12.5 cm³

12.5 x 25 cm

25 x 25 cm



Model number	32020H	38110H	32050H			
Nom. dim. - cm/in	12.5 x 12.5 / 5 x 5	12.5 x 25 / 5 x 10	25 x 25 / 10 x 10			
Work size	119 x 119 x 8 mm	119 x 244 x 8 mm	244 x 244 x 8 mm			
Surface	smooth, silky-matt	smooth, silky-matt	smooth, silky-matt			
m ² - pieces	64.000	32.000	16.000			
m ² - kg	15.360	15.680	16.960			
Bundle - pieces	66	33	14			
Bundle - m ²	1.031	1.031	0.875			
Bundle - kg	15.840	16.170	14.840			
Pallet - m ²	86.625	86.625	70.875			
Pallet - kg	1,330.500	1,358.280	1,202.040			
Product standard	Alb	Alb	Alb			
Slip resistance	-/B	-/B	-/B			
Stress group	2	2	2			
active sand grey	553037-32020H ¹ Price gr. A217 (m ²)	553037-38110H ¹ Price gr. A199 (m ²)	553037-32050H ¹ Price gr. A217 (m ²)			
light sand grey	553038-32020H Price gr. A217 (m ²)	553038-38110H Price gr. A199 (m ²)	553038-32050H ¹ Price gr. A217 (m ²)			
medium sand grey	553039-32020H Price gr. A217 (m ²)	553039-38110H ¹ Price gr. A199 (m ²)	553039-32050H ¹ Price gr. A217 (m ²)			
dark sand grey	553040-32020H Price gr. A217 (m ²)	553040-38110H ¹ Price gr. A199 (m ²)	553040-32050H ¹ Price gr. A217 (m ²)			
neutral 9 (white grey)	553119-32020H ¹ Price gr. A217 (m ²)	553119-38110H ¹ Price gr. A199 (m ²)	553119-32050H Price gr. A217 (m ²)			
neutral 8 (light grey)	553118-32020H Price gr. A217 (m ²)	553118-38110H ¹ Price gr. A199 (m ²)	553118-32050H Price gr. A217 (m ²)			
neutral 7 (pebble grey)	553117-32020H Price gr. A217 (m ²)	553117-38110H Price gr. A199 (m ²)	553117-32050H Price gr. A217 (m ²)			
neutral 6 (pearl grey)	553116-32020H ¹ Price gr. A217 (m ²)	553116-38110H Price gr. A199 (m ²)	553116-32050H ¹ Price gr. A217 (m ²)			
neutral 5 (basalt-grey)	553115-32020H ¹ Price gr. A217 (m ²)	553115-38110H ¹ Price gr. A199 (m ²)	553115-32050H ¹ Price gr. A217 (m ²)			
neutral 4 (graphite black)	553114-32020H ¹ Price gr. A217 (m ²)	553114-38110H ¹ Price gr. A199 (m ²)	553114-32050H Price gr. A217 (m ²)			
neutral 3 (asphalt black)	553113-32020H Price gr. A217 (m ²)	553113-38110H Price gr. A199 (m ²)	553113-32050H Price gr. A217 (m ²)			
neutral 2 (anthracite)	553112-32020H Price gr. A217 (m ²)	553112-38110H Price gr. A199 (m ²)	553112-32050H Price gr. A217 (m ²)			
contrasting red	77i-32020H Price gr. A217 (m ²)	77i-38110H Price gr. A199 (m ²)	77i-32050H Price gr. A217 (m ²)			



¹ Make-to-order production: return and/or cancellation of ordered products not possible.

² Rounded edges / corners refer to page 351

³ Supplied as double-tiles; to be broken by customer

All products: Color Shade Variation V0

Slip resistance „B“ – rounded edges/corners^{1/2}
Floor Tiles

12.5 x 12.5 cm



12.5 x 12.5 cm



12.5 x 25 cm



12.5 x 25 cm



12.5 x 25 cm



12.5 x 25 cm



	rounded edge	rounded corner	short side rounded	long side rounded	rounded corner left	rounded corner right	
	32025H	32027H	38115H	38116H	38117H	38118H	Model number
	12.5 x 12.5 / 5 x 5	12.5 x 12.5 / 5 x 5	12.5 x 25 / 5 x 10	12.5 x 25 / 5 x 10	12.5 x 25 / 5 x 10	12.5 x 25 / 5 x 10	Nom. dim. - cm/in
	119 x 119 x 8 mm	119 x 119 x 8 mm	119 x 244 x 8 mm	119 x 244 x 8 mm	119 x 244 x 8 mm	119 x 244 x 8 mm	Work size
	smooth, silky-matt	smooth, silky-matt	smooth, silky-matt	smooth, silky-matt	smooth, silky-matt	smooth, silky-matt	Surface
	0.240	0.240	0.490	0.490	0.490	0.490	m ² - pieces
	66	66	33	33	33	33	Pieces - kg
	15.840	15.840	16.170	16.170	16.170	16.170	Bundle - pieces
							Bundle - m ²
							Bundle - kg
							Pallet - m ²
							Pallet - kg
	Alb	Alb	Alb	Alb	Alb	Alb	Product standard
	-/B	-/B	-/B	-/B	-/B	-/B	Slip resistance
	2	2	2	2	2	2	Stress group
	91i-32025H	91i-32027H	91i-38115H	91i-38116H	91i-38117H	91i-38118H	neutral 10
	Price gr. A410 (pce.)	Price gr. A410 (pce.)	Price gr. A416 (pce.)	Price gr. A416 (pce.)	Price gr. A416 (pce.)	Price gr. A416 (pce.)	(active white)
	340i-32025H	340i-32027H	340i-38115H	340i-38116H	340i-38117H	340i-38118H	neutral 1
	Price gr. A410 (pce.)	Price gr. A410 (pce.)	Price gr. A416 (pce.)	Price gr. A416 (pce.)	Price gr. A416 (pce.)	Price gr. A416 (pce.)	(deep black)
	553001-32025H	553001-32027H	553001-38115H	553001-38116H	553001-38117H	553001-38118H	
	Price gr. A410 (pce.)	Price gr. A410 (pce.)	Price gr. A416 (pce.)	Price gr. A416 (pce.)	Price gr. A416 (pce.)	Price gr. A416 (pce.)	active azure
	553002-32025H	553002-32027H	553002-38115H	553002-38116H	553002-38117H	553002-38118H	
	Price gr. A410 (pce.)	Price gr. A410 (pce.)	Price gr. A416 (pce.)	Price gr. A416 (pce.)	Price gr. A416 (pce.)	Price gr. A416 (pce.)	light azure



25 x 25 cm



25 x 25 cm



	rounded edge	rounded corner	
	32055H	32057H	Model number
	25 x 25 / 10 x 10	25 x 25 / 10 x 10	Nom. dim. - cm/in
	244 x 244 x 8 mm	244 x 244 x 8 mm	Work size
	smooth, silky-matt	smooth, silky-matt	Surface
	1.060/piece	1.060/m ²	m ² - pieces
	14	14	pce./m ² - kg
			Bundle - pieces
			Bundle - m ²
			Bundle - kg
			Pallet - m ²
			Pallet - kg
	Alb	Alb	Product standard
	-/B	-/B	Slip resistance
	2	2	Stress group
	91i-32055H	91i-32057H	neutral 10
	Price gr. A434 (pce.)	Price gr. A434 (pce.)	(active white)
	340i-32055H	340i-32057H	neutral 1
	Price gr. A434 (pce.)	Price gr. A434 (pce.)	(deep black)
	553001-32055H	553001-32057H	
	Price gr. A434 (pce.)	Price gr. A434 (pce.)	active azure
	553002-32055H	553002-32057H	
	Price gr. A434 (pce.)	Price gr. A434 (pce.)	light azure

¹ Other colors available on request
² Make-to-order production: return and/or cancellation of ordered products not possible.



All products: Color Shade Variation V0

Rounded Edges				
Replace last figure 0 of standard model no. by 7 = corner left	... 8 = corner right	rounded edges	Example: Standard model no. 38110 = 119 x 244 x 6 mm, Model no. 38117 = rounded corner left

Slip resistance „C“

-/C



81 white / neutral 10 (active white)



554119 neutral 9 (white-grey)



554118 neutral 8 (light-grey)



554117 neutral 7 (pebble-grey)



554113 neutral 3 (asphalt black)



554111 black / neutral 1 (deep black)

-/C



554004 dark azure



554008 dark blue



554016 dark green



554036 dark stone grey



554040 dark sand grey



554003 medium azure



554007 medium blue



554011 medium turquoise



554015 medium green



554019 medium yellow



554023 medium ochre



554027 medium salmon



554031 medium oxide red



554035 medium stone grey



554039 medium sand grey



554002 light azure



554006 light blue



554010 light turquoise



554014 light green



554026 light salmon



554038 light sand grey

-/C



554001 active azure

-/C



78 contrasting red



Floor tile
12.5 x 12.5 cm, 5 x 5 in



Floor tile
12.5 x 25 cm, 5 x 10 in



Floor tile
25 x 25 cm, 10 x 10 in

On request, other colors of the series Chroma are also available as non-slip glazes with a joint width of 6 mm.

Slip resistance „C“
Floor Tiles²

12.5 x 12.5 cm³



12.5 x 25 cm



25 x 25 cm



				32020H	38110H	32050H	Model number
				12.5 x 12.5 / 5 x 5	12.5 x 25 / 5 x 10	25 x 25 / 10 x 10	Nom. dim. - cm/in
				119 x 119 x 8 mm	119 x 244 x 8 mm	244 x 244 x 8 mm	Work size
				structured, silky-matt	structured, silky-matt	structured, silky-matt	Surface
				64.000	32.000	16.000	m ² - pieces
				15.360	15.680	16.960	m ² - kg
				66	33	14	Bundle - pieces
				1.031	1.031	0.875	Bundle - m ²
				15.840	16.170	14.840	Bundle - kg
				86.625	86.625	70.875	Pallet - m ²
				1,330.560	1,358.280	1,202.040	Pallet - kg
				Alb	Alb	Alb	Product standard
				-/C	-/C	-/C	Slip resistance
				2	2	2	Stress group
				81i-32020H	81i-38110H	81i-32050H	neutral 10
				Price gr. A217 (m ²)	Price gr. A199 (m ²)	Price gr. A217 (m ²)	(active white)
				554111-32020H	554111-38110H	554111-32050H¹	neutral 1
				Price gr. A217 (m ²)	Price gr. A199 (m ²)	Price gr. A217 (m ²)	(deep black)
				554001-32020H	554001-38110H	554001-32050H¹	active azure
				Price gr. A217 (m ²)	Price gr. A199 (m ²)	Price gr. A217 (m ²)	
				554002-32020H	554002-38110H	554002-32050H	light azure
				Price gr. A217 (m ²)	Price gr. A199 (m ²)	Price gr. A217 (m ²)	
				554003-32020H	554003-38110H	554003-32050H	medium azure
				Price gr. A217 (m ²)	Price gr. A199 (m ²)	Price gr. A217 (m ²)	
				554004-32020H	554004-38110H	554004-32050H¹	dark azure
				Price gr. A217 (m ²)	Price gr. A199 (m ²)	Price gr. A217 (m ²)	
				554006-32020H	554006-38110H	554006-32050H¹	light blue
				Price gr. A217 (m ²)	Price gr. A199 (m ²)	Price gr. A217 (m ²)	
				554007-32020H	554007-38110H	554007-32050H¹	medium blue
				Price gr. A217 (m ²)	Price gr. A199 (m ²)	Price gr. A217 (m ²)	
				554008-32020H	554008-38110H	554008-32050H¹	dark blue
				Price gr. A217 (m ²)	Price gr. A199 (m ²)	Price gr. A217 (m ²)	
				554010-32020H	554010-38110H	554010-32050H¹	light turquoise
				Price gr. A217 (m ²)	Price gr. A199 (m ²)	Price gr. A217 (m ²)	
				554011-32020H	554011-38110H	554011-32050H¹	medium turquoise
				Price gr. A217 (m ²)	Price gr. A199 (m ²)	Price gr. A217 (m ²)	
				554014-32020H	554014-38110H¹	554014-32050H¹	light green
				Price gr. A217 (m ²)	Price gr. A199 (m ²)	Price gr. A217 (m ²)	
				554015-32020H	554015-38110H¹	554015-32050H¹	medium green
				Price gr. A217 (m ²)	Price gr. A199 (m ²)	Price gr. A217 (m ²)	
				554016-32020H	554016-38110H	554016-32050H	dark green
				Price gr. A217 (m ²)	Price gr. A199 (m ²)	Price gr. A217 (m ²)	
				554019-32020H	554019-38110H	554019-32050H¹	medium yellow
				Price gr. A217 (m ²)	Price gr. A199 (m ²)	Price gr. A217 (m ²)	
				554023-32020H	554023-38110H	554023-32050H	medium ochre
				Price gr. A217 (m ²)	Price gr. A199 (m ²)	Price gr. A217 (m ²)	
				554026-32020H¹	554026-38110H¹	554026-32050H¹	light salmon
				Price gr. A217 (m ²)	Price gr. A199 (m ²)	Price gr. A217 (m ²)	
				554027-32020H	554027-38110H	554027-32050H¹	medium salmon
				Price gr. A217 (m ²)	Price gr. A199 (m ²)	Price gr. A217 (m ²)	
				554031-32020H	554031-38110H	554031-32050H¹	medium oxide red
				Price gr. A217 (m ²)	Price gr. A199 (m ²)	Price gr. A217 (m ²)	
				554035-32020H	554035-38110H	554035-32050H¹	medium stone grey
				Price gr. A217 (m ²)	Price gr. A199 (m ²)	Price gr. A217 (m ²)	
				554036-32020H	554036-38110H	554036-32050H¹	dark stone grey
				Price gr. A217 (m ²)	Price gr. A199 (m ²)	Price gr. A217 (m ²)	
				554038-32020H	554038-38110H	554038-32050H	light sand grey
				Price gr. A217 (m ²)	Price gr. A199 (m ²)	Price gr. A217 (m ²)	
				554039-32020H	554039-38110H	554039-32050H¹	medium sand grey
				Price gr. A217 (m ²)	Price gr. A199 (m ²)	Price gr. A217 (m ²)	
				554040-32020H	554040-38110H	554040-32050H¹	dark sand grey
				Price gr. A217 (m ²)	Price gr. A199 (m ²)	Price gr. A217 (m ²)	
				554119-32020H¹	554119-38110H	554119-32050H¹	neutral 9
				Price gr. A217 (m ²)	Price gr. A199 (m ²)	Price gr. A217 (m ²)	(white grey)
				554118-32020H	554118-38110H	554118-32050H¹	neutral 8
				Price gr. A217 (m ²)	Price gr. A199 (m ²)	Price gr. A217 (m ²)	(light grey)
				554117-32020H	554117-38110H	554117-32050H	neutral 7
				Price gr. A217 (m ²)	Price gr. A199 (m ²)	Price gr. A217 (m ²)	(pebble grey)
				554113-32020H	554113-38110H	554113-32050H	neutral 3
				Price gr. A217 (m ²)	Price gr. A199 (m ²)	Price gr. A217 (m ²)	(asphalt black)
				78i-32020H	78i-38110H	78i-32050H¹	contrasting red
				Price gr. A217 (m ²)	Price gr. A199 (m ²)	Price gr. A217 (m ²)	

¹ Make-to-order production: return and/or cancellation of ordered products not possible.

² Rounded edges / corners refer to page 354

³ Supplied as double-tiles; to be broken by customer



Slip resistance „C“ – rounded edges / corners^{1/2}

Floor Tiles

12.5 x 12.5 cm



12.5 x 12.5 cm



12.5 x 25 cm



12.5 x 25 cm



12.5 x 25 cm



12.5 x 25 cm



rounded edge

rounded corner

short side rounded

long side rounded

rounded corner left

rounded corner right

Model number	32025H	32027H	38115H	38116H	38117H	38118H
Nom. dim. - cm/in	12.5 x 12.5 / 5 x 5	12.5 x 12.5 / 5 x 5	12.5 x 25 / 5 x 10	12.5 x 25 / 5 x 10	12.5 x 25 / 5 x 10	12.5 x 25 / 5 x 10
Work size	119 x 119 x 8 mm	119 x 119 x 8 mm	119 x 244 x 8 mm	119 x 244 x 8 mm	119 x 244 x 8 mm	119 x 244 x 8 mm
Surface	structured, silky-matt	structured, silky-matt	structured, silky-matt	structured, silky-matt	structured, silky-matt	structured, silky-matt
m ² - pieces						
Pieces - kg	0.240	0.240	0.490	0.490	0.490	0.490
Bundle - pieces	66	66	33	33	33	33
Bundle - m ²						
Bundle - kg	15.840	15.840	16.170	16.170	16.170	16.170
Pallet - m ²						
Pallet - kg						
Product standard	Alb	Alb	Alb	Alb	Alb	Alb
Slip resistance	-/C ☒	-/C ☒	-/C ☒	-/C ☒	-/C ☒	-/C ☒
Stress group	2	2	2	2	2	2
neutral 10	81i-32025H	81i-32027H	81i-38115H	81i-38116H	81i-38117H	81i-38118H
(active white)	Price gr. A410 (pce.)	Price gr. A410 (pce.)	Price gr. A416 (pce.)	Price gr. A416 (pce.)	Price gr. A416 (pce.)	Price gr. A416 (pce.)
neutral 1	554111-32025H	554111-32027H	554111-38115H	554111-38116H	554111-38117H	554111-38118H
(deep black)	Price gr. A410 (pce.)	Price gr. A410 (pce.)	Price gr. A416 (pce.)	Price gr. A416 (pce.)	Price gr. A416 (pce.)	Price gr. A416 (pce.)
	554001-32025H	554001-32027H	554001-38115H	554001-38116H	554001-38117H	554001-38118H
active azure	Price gr. A410 (pce.)	Price gr. A410 (pce.)	Price gr. A416 (pce.)	Price gr. A416 (pce.)	Price gr. A416 (pce.)	Price gr. A416 (pce.)
	554002-32025H	554002-32027H	554002-38115H	554002-38116H	554002-38117H	554002-38118H
light azure	Price gr. A410 (pce.)	Price gr. A410 (pce.)	Price gr. A416 (pce.)	Price gr. A416 (pce.)	Price gr. A416 (pce.)	Price gr. A416 (pce.)



25 x 25 cm



25 x 25 cm

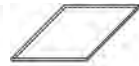

rounded edge

rounded corner

Model number	32055H	32057H			
Nom. dim. - cm/in	25 x 25 / 10 x 10	25 x 25 / 10 x 10			
Work size	244 x 244 x 8 mm	244 x 244 x 8 mm			
Surface	structured, silky-matt	structured, silky-matt			
m ² - pieces					
Pieces - kg	1.060	1.060			
Bundle - pieces	14	14			
Bundle - m ²					
Bundle - kg	14.840	14.840			
Pallet - m ²					
Pallet - kg					
Product standard	Alb	Alb			
Slip resistance	-/C ☒	-/C ☒			
Stress group	2	2			
neutral 10	81i-32055H	81i-32057H			
(active white)	Price gr. A434 (pce.)	Price gr. A434 (pce.)			
neutral 1	554111-32055H	554111-32057H			
(deep black)	Price gr. A434 (pce.)	Price gr. A434 (pce.)			
	554001-32055H	554001-32057H			
active azure	Price gr. A434 (pce.)	Price gr. A434 (pce.)			
	554002-32055H	554002-32057H			
light azure	Price gr. A434 (pce.)	Price gr. A434 (pce.)			



¹ Other colors available on request

² Make-to-order production: return and/or cancellation of ordered products not possible.

All products: Color Shade Variation V0



Rounded Edges

Replace last figure 0 of standard model no. by ...

... 7 = corner left

... 8 = corner right

rounded edges

Example: Standard model no. 38110 = 119 x 244 x 6 mm, Model no. 38117 = rounded corner left



Project: Oasia Hotel / Location: Singapore / Architect: WOHA Architects + Patricia Urquiola / Series: Chroma non-slip, Chroma / Photo: Infitude





Quantum



926
white / neutral 10 (active white)



555023
medium ochre

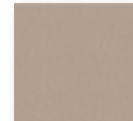

Floor/wall tile
12.5 x 12.5 cm, 5 x 5 in



555118
neutral 8 (white-grey)



555036
dark stone grey



555035
medium stone grey

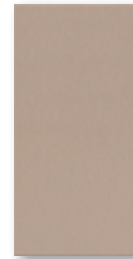

Floor/wall tile
12.5 x 25 cm, 5 x 10 in



555117
neutral 7 (pebble-grey)



555040
dark sand grey



555039
medium sand grey



555038
light sand grey



555113
neutral 3 (asphalt black)



918
black / neutral 1 (deep black)

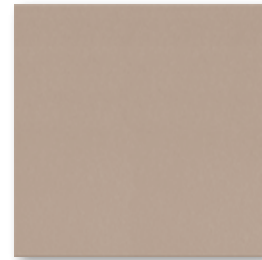

Floor/wall tile
25 x 25 cm, 10 x 10 in

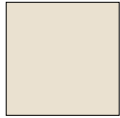

901
natural-white

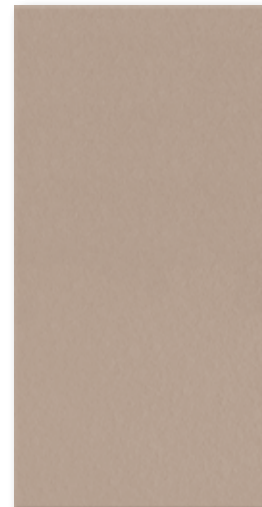

Floor/wall tile
25 x 50 cm, 10 x 20 in

Grid profile

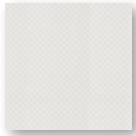

Grid profile tile
12.5 x 12.5 cm, 5 x 5 in

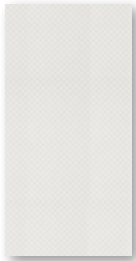

Grid profile tile
12.5 x 25 cm, 5 x 10 in

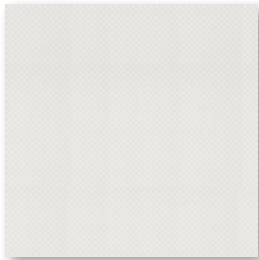

Grid profile tile
25 x 25 cm, 10 x 10 in

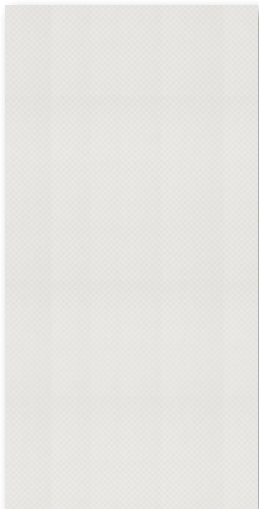

Grid profile tile
25 x 50 cm, 10 x 20 in

Shower Tub System

Shower tub system
Corner (one piece)
12.5 x 12.5 cm, 5 x 5 in



Shower tub system
Strip
12.5 x 12.5 cm
5 x 5 in

Shower tub system
Strip
25 x 12.5 cm, 10 x 5 in

Cove skirting, r = 12 mm,
25 x 12.5 cm, 10 x 5 in



External angle,
mitred pair

Internal angle,
mitred pair

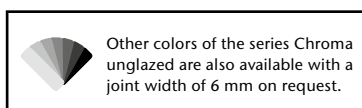

Other colors of the series Chroma unglazed are also available with a joint width of 6 mm on request.

Quantum

Floor/Wall Tiles

12.5 x 12.5 cm³



12.5 x 25 cm



25 x 25 cm



25 x 50 cm^{1/2}

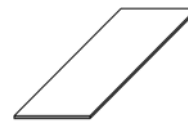

Model number	32020H	38110H	32050H	42550HK		
Nom. dim. - cm/in	12.5 x 12.5 / 5 x 5	12.5 x 25 / 5 x 10	25 x 25 / 10 x 10	25 x 50 / 10 x 20		
Work size	119 x 119 x 8 mm	119 x 244 x 8 mm	244 x 244 x 8 mm	244 x 494 x 8 mm		
Surface	smooth, silky-matt	smooth, silky-matt	smooth, silky-matt	smooth, silky-matt		
m ² - pieces	64.000	32.000	16.000	8.000		
m ² - kg	15.360	15.680	16.960	17.040		
Bundle - pieces	66	33	14	9		
Bundle - m ²	1.031	1.031	0.875	1.125		
Bundle - kg	15.840	16.170	14.840	19.170		
Pallet - m ²	86.625	86.625	70.875	40.500		
Pallet - kg	1,330.560	1,358.280	1,202.040	690.120		
Product standard	Alb	Alb	Alb	Alb		
Slip resistance	R10/A	R10/A	R10/A	R10/A		
Stress group	2	2	2	2		
neutral 10 (active white)	926i-32020H Price gr. A166 (m ²)	926i-38110H Price gr. A166 (m ²)	926i-32050H Price gr. A166 (m ²)	926i-42550HK Price gr. A178 (m ²)		
neutral 1 (deep black)	918i-32020H Price gr. A166 (m ²)	918i-38110H Price gr. A166 (m ²)	918i-32050H Price gr. A166 (m ²)	918i-42550HK Price gr. A178 (m ²)		
medium ochre	555023-32020H¹ Price gr. A166 (m ²)	555023-38110H¹ Price gr. A166 (m ²)	555023-32050H¹ Price gr. A166 (m ²)	555023-42550HK Price gr. A178 (m ²)		
medium stone grey	555035-32020H¹ Price gr. A166 (m ²)	555035-38110H¹ Price gr. A166 (m ²)	555035-32050H¹ Price gr. A166 (m ²)	555035-42550HK Price gr. A178 (m ²)		
dark stone grey	555036-32020H¹ Price gr. A166 (m ²)	555036-38110H¹ Price gr. A166 (m ²)	555036-32050H¹ Price gr. A166 (m ²)	555036-42550HK Price gr. A178 (m ²)		
light sand grey	555038-32020H¹ Price gr. A166 (m ²)	555038-38110H¹ Price gr. A166 (m ²)	555038-32050H¹ Price gr. A166 (m ²)	555038-42550HK Price gr. A178 (m ²)		
medium sand grey	555039-32020H¹ Price gr. A166 (m ²)	555039-38110H¹ Price gr. A166 (m ²)	555039-32050H¹ Price gr. A166 (m ²)	555039-42550HK Price gr. A178 (m ²)		
dark sand grey	555040-32020H¹ Price gr. A166 (m ²)	555040-38110H¹ Price gr. A166 (m ²)	555040-32050H¹ Price gr. A166 (m ²)	555040-42550HK Price gr. A178 (m ²)		
neutral 3 (asphalt black)	555113-32020H¹ Price gr. A166 (m ²)	555113-38110H¹ Price gr. A166 (m ²)	555113-32050H¹ Price gr. A166 (m ²)	555113-42550HK Price gr. A178 (m ²)		
neutral 7 (pebble grey)	555117-32020H¹ Price gr. A166 (m ²)	555117-38110H¹ Price gr. A166 (m ²)	555117-32050H¹ Price gr. A166 (m ²)	555117-42550HK Price gr. A178 (m ²)		
neutral 8 (light grey)	555118-32020H¹ Price gr. A166 (m ²)	555118-38110H¹ Price gr. A166 (m ²)	555118-32050H¹ Price gr. A166 (m ²)	555118-42550HK Price gr. A178 (m ²)		
natural-white	901i-32020H Price gr. A166 (m ²)	901i-38110H Price gr. A166 (m ²)	901i-32050H Price gr. A166 (m ²)	901i-42550HK Price gr. A178 (m ²)		



¹  Make-to-order production: return and/or cancellation of ordered products not possible.
Minimum order quantity: 200 m²

²  rectified

³ Supplied as double-tiles; to be broken by customer

All products: Color Shade Variation V0

Quantum

Floor Tiles

12.5 x 12.5 cm³



12.5 x 25 cm



25 x 25 cm



25 x 50 cm^{1/2}



			Grid profile tile	Grid profile tile	Grid profile tile	Grid profile tile	
			32100H	34090H	32080H	42580HK	Model number
			12.5 x 12.5 / 5 x 5	12.5 x 25 / 5 x 10	25 x 25 / 10 x 10	25 x 50 / 10 x 20	Nom. dim. - cm/in
			119 x 119 x 8 mm	119 x 244 x 8 mm	244 x 244 x 8 mm	244 x 494 x 8 mm	Work size
			relief, silky-matt	relief, silky-matt	relief, silky-matt	relief, silky-matt	Surface
			64.000	32.000	16.000	8.000	m ² - pieces
			15.360	15.360	16.800	17.040	m ² - kg
			66	33	14	9	Bundle - pieces
			1.031	1.031	0.875	1.125	Bundle - m ²
			15.840	15.840	14.700	19.170	Bundle - kg
			86.625	86.625	70.875	40.500	Pallet - m ²
			1,330.560	1,330.560	1,190.700	690.120	Pallet - kg
			Alb	Alb	Alb	Alb	Product standard
			R11/B	R11/B	R11/B	R11/B	Slip resistance
			2	2	2	2	Stress group
			926i-32100H	926i-34090H	926i-32080H	926i-42580HK	neutral 10
			Price gr. A178 (m ²)	Price gr. A178 (m ²)	Price gr. A178 (m ²)	Price gr. A196 (m ²)	(active white)
			918i-32100H	918i-34090H	918i-32080H	918i-42580HK	neutral 1
			Price gr. A178 (m ²)	Price gr. A178 (m ²)	Price gr. A178 (m ²)	Price gr. A196 (m ²)	(deep black)
			555023-32100H¹	555023-34090H¹	555023-32080H¹	555023-42580HK	
			Price gr. A178 (m ²)	Price gr. A178 (m ²)	Price gr. A178 (m ²)	Price gr. A196 (m ²)	medium ochre
			555035-32100H¹	555035-34090H¹	555035-32080H¹	555035-42580HK	
			Price gr. A178 (m ²)	Price gr. A178 (m ²)	Price gr. A178 (m ²)	Price gr. A196 (m ²)	medium stone grey
			555036-32100H¹	555036-34090H¹	555036-32080H¹	555036-42580HK	
			Price gr. A178 (m ²)	Price gr. A178 (m ²)	Price gr. A178 (m ²)	Price gr. A196 (m ²)	dark stone grey
			555038-32100H¹	555038-34090H¹	555038-32080H¹	555038-42580HK	
			Price gr. A178 (m ²)	Price gr. A178 (m ²)	Price gr. A178 (m ²)	Price gr. A196 (m ²)	light sand grey
			555039-32100H¹	555039-34090H¹	555039-32080H¹	555039-42580HK	
			Price gr. A178 (m ²)	Price gr. A178 (m ²)	Price gr. A178 (m ²)	Price gr. A196 (m ²)	medium sand grey
			555040-32100H¹	555040-34090H¹	555040-32080H¹	555040-42580HK	
			Price gr. A178 (m ²)	Price gr. A178 (m ²)	Price gr. A178 (m ²)	Price gr. A196 (m ²)	dark sand grey
			555113-32100H¹	555113-34090H¹	555113-32080H¹	555113-42580HK	neutral 3
			Price gr. A178 (m ²)	Price gr. A178 (m ²)	Price gr. A178 (m ²)	Price gr. A196 (m ²)	(asphalt black)
			555117-32100H¹	555117-34090H¹	555117-32080H¹	555117-42580HK	neutral 7
			Price gr. A178 (m ²)	Price gr. A178 (m ²)	Price gr. A178 (m ²)	Price gr. A196 (m ²)	(pebble grey)
			555118-32100H¹	555118-34090H¹	555118-32080H¹	555118-42580HK	neutral 8
			Price gr. A178 (m ²)	Price gr. A178 (m ²)	Price gr. A178 (m ²)	Price gr. A196 (m ²)	(light grey)
			901i-32100H	901i-34090H	901i-32080H	901i-42580HK	
			Price gr. A178 (m ²)	Price gr. A178 (m ²)	Price gr. A178 (m ²)	Price gr. A196 (m ²)	natural-white

¹ Make-to-order production: return and/or cancellation of ordered products not possible. Minimum order quantity: 200 m²

² rectified

³ Supplied as double-tiles; to be broken by customer

All products: Color Shade Variation V0



Quantum

Shower Tub System¹

12.5 x 25 cm



Lip 10 mm

12.5 x 12.5 cm



Lip 10 mm

12.5 x 12.5 cm



Strip

Strip

Corner

Model number	27182H	27180H	27181H
Nom. dim. - cm/in	12.5 x 25 / 5 x 10	12.5 x 12.5 / 5 x 5	12.5 x 12.5 / 5 x 5
Work size	119 x 244 x 18/8 mm	119 x 119 x 18/8 mm	119 x 119 x 18/8 mm
Surface	smooth, silky-matt	smooth, silky-matt	smooth, silky-matt
m - pieces	4.000	8.000	
m/St. - kg	2.720/m	2.720/m	0.500/piece
Bundle - pieces	22	44	12
Bundle - m	5.500	5.500	
Bundle - kg	14.960	14.960	6.000
Pallet - m			
Pallet - kg			
Product standard	Alb	Alb	Alb
Slip resistance	R10/B	R10/B	R10/B
neutral 10 (active white)	926i-27182H Price gr. A506 (pce.)	926i-27180H Price gr. A455 (pce.)	926i-27181H Price gr. A489 (pce.)
neutral 1 (deep black)	918i-27182H Price gr. A506 (pce.)	918i-27180H Price gr. A455 (pce.)	918i-27181H Price gr. A489 (pce.)
medium ochre	555023-27182H ² Price gr. A506 (pce.)	555023-27180H ² Price gr. A455 (pce.)	555023-27181H ² Price gr. A489 (pce.)
medium stone grey	555035-27182H ² Price gr. A506 (pce.)	555035-27180H ² Price gr. A455 (pce.)	555035-27181H ² Price gr. A489 (pce.)
dark stone grey	555036-27182H ² Price gr. A506 (pce.)	555036-27180H ² Price gr. A455 (pce.)	555036-27181H ² Price gr. A489 (pce.)
light sand grey	555038-27182H ² Price gr. A506 (pce.)	555038-27180H ² Price gr. A455 (pce.)	555038-27181H ² Price gr. A489 (pce.)
medium sand grey	555039-27182H ² Price gr. A506 (pce.)	555039-27180H ² Price gr. A455 (pce.)	555039-27181H ² Price gr. A489 (pce.)
dark sand grey	555040-27182H ² Price gr. A506 (pce.)	555040-27180H ² Price gr. A455 (pce.)	555040-27181H ² Price gr. A489 (pce.)
neutral 3 (asphalt black)	555113-27182H ² Price gr. A506 (pce.)	555113-27180H ² Price gr. A455 (pce.)	555113-27181H ² Price gr. A489 (pce.)
neutral 7 (pebble grey)	555117-27182H ² Price gr. A506 (pce.)	555117-27180H ² Price gr. A455 (pce.)	555117-27181H ² Price gr. A489 (pce.)
neutral 8 (light grey)	555118-27182H ² Price gr. A506 (pce.)	555118-27180H ² Price gr. A455 (pce.)	555118-27181H ² Price gr. A489 (pce.)
natural-white	901i-27182H Price gr. A506 (pce.)	901i-27180H Price gr. A455 (pce.)	901i-27181H Price gr. A489 (pce.)

¹ For details, refer to page 715

² Make-to-order production: return and/or cancellation of ordered products not possible.

All products: Color Shade Variation V0

Quantum

Safety Strip Tile^{1/2}

6.2 x 25 cm



Grooved, rounded
long edge

Skirtings²

7.9 x 25 cm



Skirting

12.5 x 25 cm³



Skirting
r = 12 mm



External angle
mitred pair



Internal angle
mitred pair



Model number	Nom. dim. - cm/in	Work size	Surface	m - pieces	m/pair - kg	Bundle - pce./pair	Bundle - m	Bundle - kg	Pallet - m	Pallet - kg	Product standard	Slip resistance
34306H	6.2 x 25 / 2 1/2 x 10	56 x 244 x 8 mm	smooth, silky-matt	4.000	0.800/m	66 pieces	16.500	13.200				neutral 10
Alb	-/C											(active white)
918i-34306H												neutral 1
	Price gr. A434 (pce.)											(deep black)
												natural-white
34020H	7.9 x 25 / 3 1/8 x 10	73 x 244 x 8 mm	smooth, silky-matt	4.000	1.160/m	33 pieces	8.250	9.570				
Alb												
926i-34020H												
	Price gr. A410 (pce.)											
918i-34020H												
	Price gr. A410 (pce.)											
901i-34020H												
	Price gr. A410 (pce.)											
37080	12.5 x 25 / 5 x 10	125 x 244/12 x 8 mm	smooth, silky-matt	4.000	2.520/m	20 pieces	5.000	12.600				
Alb												
926-37080												
	Price gr. A423 (pce.)											
918-37080												
	Price gr. A423 (pce.)											
901-37080												
	Price gr. A423 (pce.)											
37081	(2x) 131 x 125/12 x 8 mm	(2x) 119 x 125/12 x 8 mm	smooth, silky-matt	0.600/pair	10 pairs							
Alb												
926-37081												
	Price gr. A455 (pair)											
918-37081												
	Price gr. A455 (pair)											
901-37081												
	Price gr. A455 (pair)											
37082	(2x) 119 x 125/12 x 8 mm	(2x) 119 x 125/12 x 8 mm	smooth, silky-matt	0.400/pair	10 pairs							
Alb												
926-37082												
	Price gr. A455 (pair)											
918-37082												
	Price gr. A455 (pair)											
901-37082												
	Price gr. A455 (pair)											

¹ Especially suitable for non-slip and clearly visible (stair) edge design.

² Other colors available on request

³ The cove skirting complies with DIN EN 14411, group Al_b, glazed (GL)

All products: Color Shade Variation V0



362 POOL EDGE SYSTEMS

Project: BLU Sports and leisure pool / Location: Potsdam, Germany / Architect: GMP Gerkan, Marg und Partner, Berlin / Series: Chroma, Pool edge system Wiesbaden, Plural / Photo: Jochen Stüber

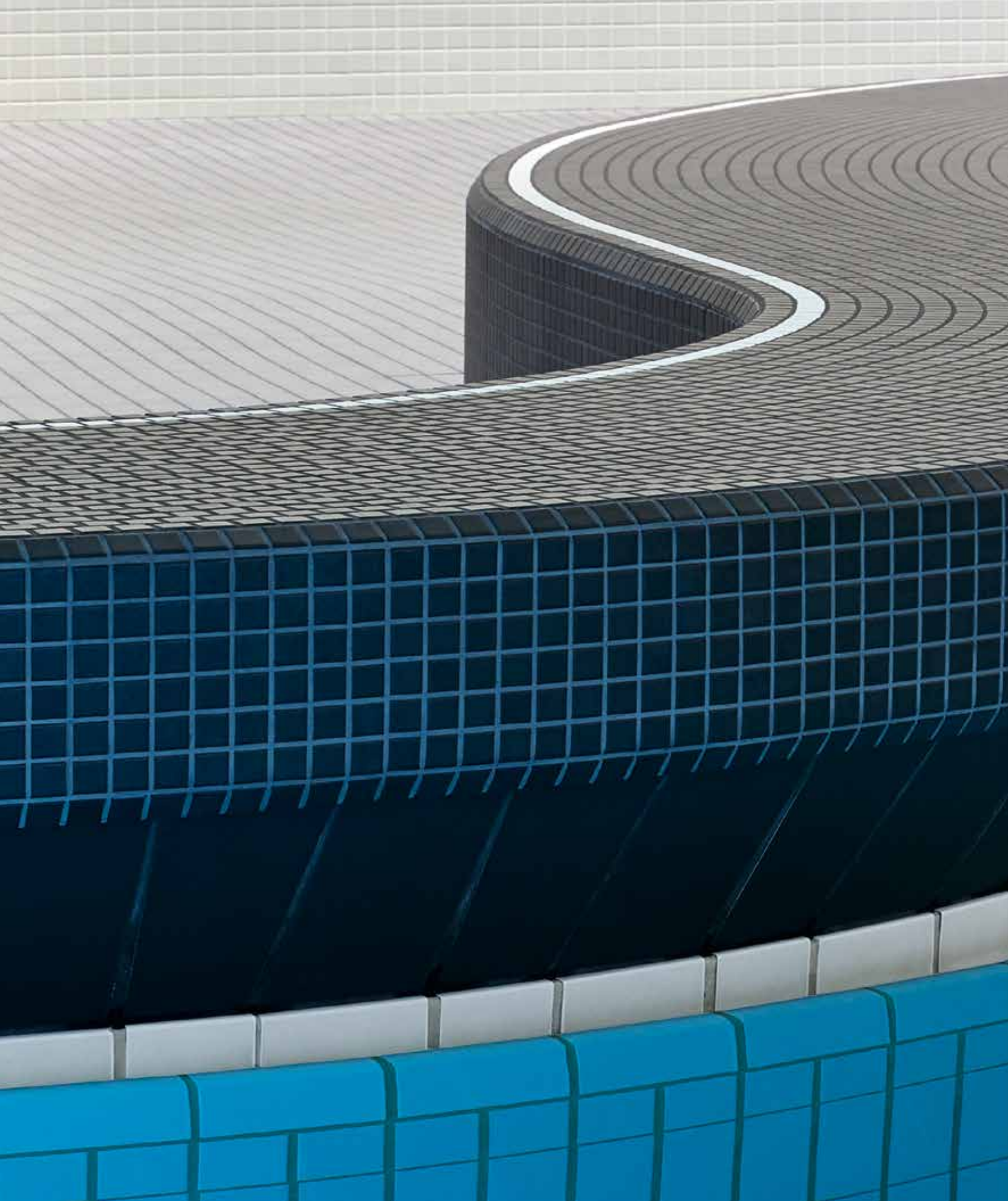



The right edge for every pool

Not all baths are the same: different types of use of sports, leisure and adventure pools, therapy baths, private and hotel pools or sports and competition pools require different pool planning concepts. They all demand a sophisticated design of the pool and its surround. This works with modularly combinable components. In addition to tiles for the surfaces, this also applies to ceramic pool edge systems. They are made of solid stoneware without cavities and are therefore particularly robust. Besides proven classics, the range also includes innovations such as the energy-saving Bamberg system.

- System Finland I + II
- System Wiesbaden
- System Bamberg
- System St. Moritz
- System Berlin
- System Zürich
- System Skimmer

The pool edge systems at a glance

System
Finnland

System
Finnland II

System
Wiesbaden



Sloping, beach-like pool edge with handhold-piece; covered channel with covered gutter tile and outlet valve SILENT 100.

Sloping, beach-like pool edge with handhold-piece and inclined grooved tile; covered channel with covered gutter tile and outlet valve SILENT 100.

Large overflow channel with handhold-piece, cover grating and outlet valve SILENT W 2000.

Type of pool

Sports and competition pools, leisure and adventure pools, open-air swimming pools.

Sports and competition pools, leisure and adventure pools, open-air swimming pools.

Leisure and adventure pools, thermal baths, open-air swimming pools.

Advantages for users and operators

Minimal wave rebound thanks to beach-like pool edge; different channel volumes (as required) are possible, easy exit due to elevated water level.

Minimal wave rebound thanks to beach-like pool edge; different channel volumes (as required) are possible, easy exit due to elevated water level.

Rational design thanks to large overflow channel, which combines all requirements (overflow edge, handhold-piece, channel, support for cover grating).

Variants *

Thanks to 150 mm and 119 mm wide special pieces and arrangement in several rows, different widths can be realized, also applicable in areas of radii. With the internal corner, the water circulation in corner areas can be optimized. In the case of this version, the corners are easier to clean. When used in private pools, also possible with ceramic channel cover.

Inclined grooved tile for simplified concrete construction, reduction of the number of joints in case of 50 cm long special pieces.

Large channel with mosaic recess, "low-noise channel" Wiesbaden Silent, small channel.

Available accessories

Outlet valve Silent 100, Agrob Buchtal plastic cover gratings.

Outlet valve Silent 100, Agrob Buchtal plastic cover gratings.

Outlet valve Silent W 2000, transverse grating in light-grey and white, special colors possible. "Inclined gratings" for the reduction of differences in height in areas of stairs and ramps.

* Special colors on request.

System
Wiesbaden Stil

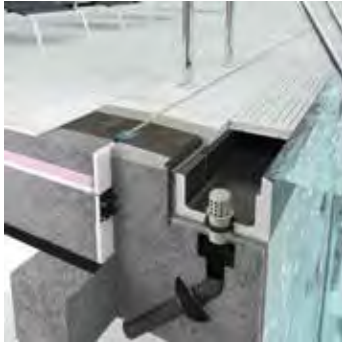

Large overflow channel with handhold-piece, ceramic channel cover and outlet valve SILENT W 2000.

Private and hotel pools.

Particularly aesthetic: channel cover made of ceramics in the same look as the covering of the pool surround. Aesthetically appealing design of the handhold-piece.

On request, also available with mosaic recess.

Outlet valve Silent W 2000.
Ceramic channel cover 2.0.

System
Wiesbaden
decreased water level



Large overflow channel with handhold-piece.

Private and hotel pools.

Particularly aesthetic: the version with decreased water level permits an additional "accumulation height" which is desired above all for the use of water attractions. Thus, this system is optimally suitable, for example, for pools with water slides.

Different channel cross-sections and dimensions expand the application possibilities, among other things, in case of elevated pool walls in flow channels.

Outlet valve Silent W 2000.

System
Wiesbaden,
therapy pools



Small overflow channel (without cover grating) with outlet valve SILENT W 2000.

Therapy pools,
pools with water slides etc.

In case of therapeutic applications, the system allows back-friendly working with the patient.

In case of therapeutic applications, the system allows back-friendly working with the patient.

Outlet valve Silent W 2000.

The pool edge systems at a glance

System Bamberg

System St. Moritz

System Berlin



Large overflow channel with handhold-piece, outlet (Ø 75 mm), without cover grating.



Elevated pool edge system with handhold-piece; overflow via the outside walls into a channel with cover grating.



Elevated overflow edge as an ideal handhold; covered channel with "smooth" water inflow.

Type of pool

Leisure and adventure pools, thermal baths, private and hotel pools.

Leisure and adventure pools, private and hotel pools.

Leisure and adventure pools.

Advantages for users and operators

Consistent look through to the pool edge, as there are no cover gratings; low water consumption and considerably lower energy requirement; low noise level; rational design thanks to large overflow channel.

Lower foundation depth required, "elevated" pool, special "view" (Infinity Pool), different channel volumes (as required) are possible.

Overflow channel (cover grating) directly borders the pool; therefore, an alternative to the Wiesbaden channel; however, different channel volumes (as required) are possible.

Variants *

Different colors for handhold-piece and channel are possible; special colors are possible after a check.

Any pool edge widths and edge covers can be realized.

Different channel variants (width, depth) are possible.

Available accessories

Outlet valve Silent W 2000.

Outlet valve Silent 100, Agrob Buchtal plastic cover gratings.

Outlet valve Silent 100, Agrob Buchtal plastic cover gratings.

* Special colors on request.

System Zürich

System Skimmer

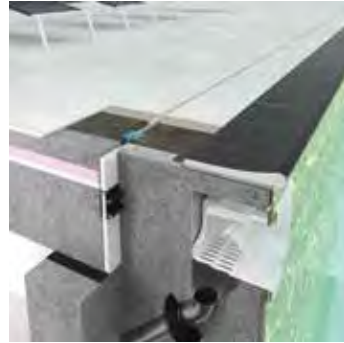

Elevated overflow edge as an ideal handhold; covered channel with covered gutter tile and outlet valve SILENT 100.

With pool edging tile Residence.

Leisure and adventure pools.

Private pools.

Different channel volumes (as required) are possible.

“Simple” rough concrete body, minimal effort for water technology (number of pipes).

Different pool edging tiles and channel variants are possible.

Pool edge designs with different special pieces are possible.

Outlet valve Silent 100, Agrob Buchtal plastic cover gratings.





All-rounder with beach effect

The Finland system and its variant Finland II are characterized by great versatility: both are ideally suited for sports and competition pools, adventure and open-air swimming pools. The sloping, beach-like pool edge reduces wave rebound and, in combination with the outlet valve Silent 100, helps to reduce the noise level in indoor swimming pools.

System Finland (classic)

The pool edge system with the sloping pool edge, which has been tried and tested for decades in a wide variety of pools, has an integrated handhold-piece and can also be used in radial areas. The elevated water level makes it easier for pool users to get out of the pool. Different channel volumes are possible depending on requirements.

Finnland (classic)

Thanks to 150 and 119 mm wide special pieces and arrangement in several rows, different widths can be realized. The outlet valve Silent 100 and plastic cover gratings are available as accessories. If used in private pools, a ceramic channel cover can also be used.

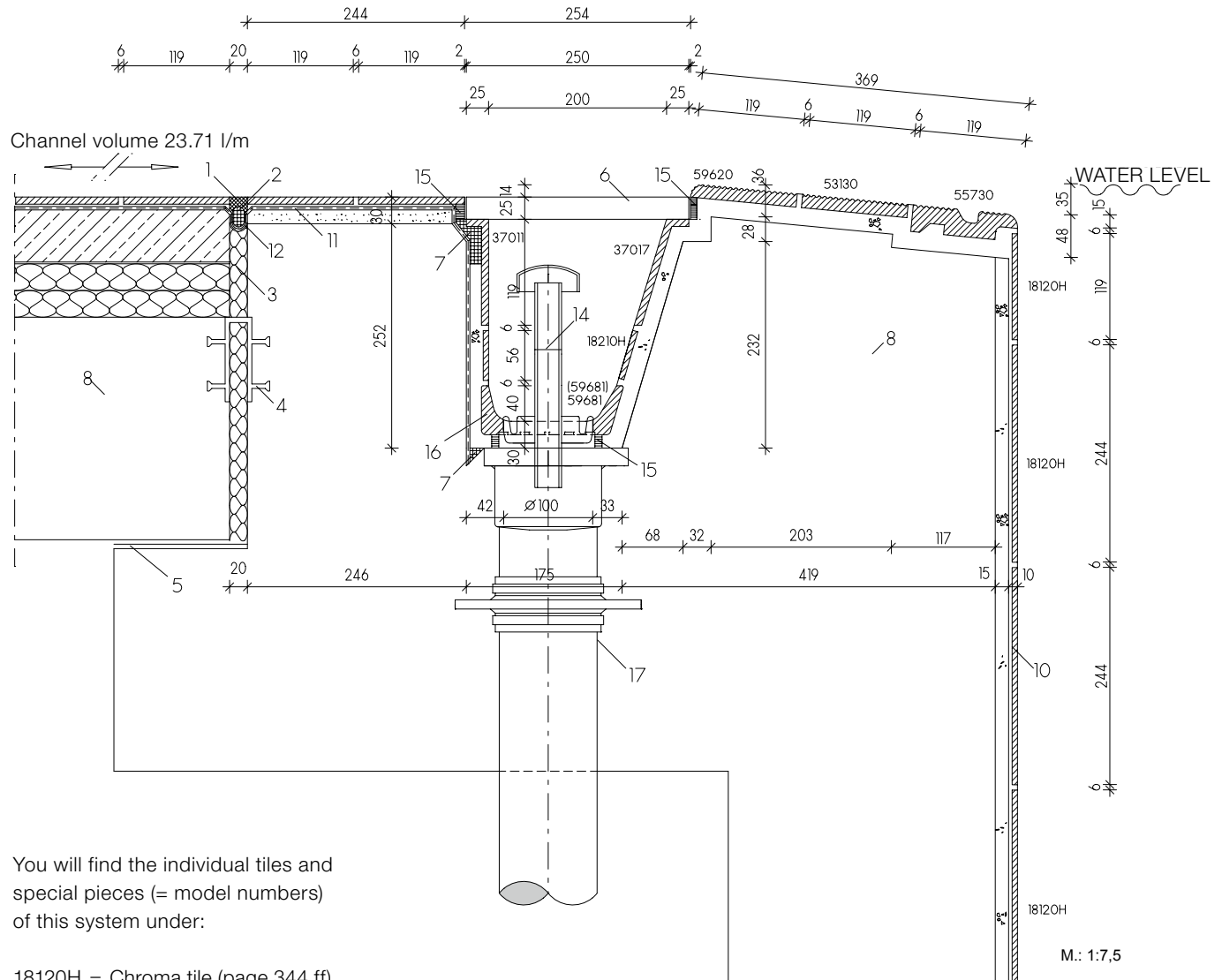

You will find the individual tiles and special pieces (= model numbers) of this system under:

- 18120H = Chroma tile (page 344 ff)
- 55730 = Handhold-piece (page 371)
- 53130 = Grooved tile (page 436)
- 59620 = Grooved tile (page 437)
- 37017 = inclined shank-tile (page 443)
- 18210H = Chroma strip tile (page 344 ff)
- 59681 = Covered gutter tile with outlet (page 443)
- 37011 = Shank-tile (page 443)
- Cover grating (page 454)
- Outlet valve Silent 100 (page 456)

Legend:

- 01 UW-Silicone
- 02 Closed-cell polyethylene foam round lace
- 03 Elastic water-resistant filling material
- 04 Joint band
- 05 Slide bearing
- 06 Agrob Buchtal plastic cover grating

- 07 Capillary barrier/grouting (reaction resin filler)
- 08 Waterproof concrete (according to DIN EN 206/DIN 1045/DAfStB WU Guideline)
- 09 Conventional thick-bed laying
- 10 Thin-bed laying on cement render (P III, CS IV without added lime)
- 11 Sealing layer
- 12 Sealing tape
- 13 Outlet valve „Silent W 2000“ of Agrob Buchtal
- 14 Air inlet pipe for outlet „Silent 100“
- 15 Epoxi for joints (for the projekt sector)
- 16 Agrob Buchtal section stoneware pipe
- 17 Casing for water inlet/ outlet pipe and brazing collar

Handhold-piece (119 mm wide) with non-slip safety marking



Handhold-piece	"Half-size" handhold-piece	Terminal piece left Corner radius 30 mm	Terminal piece right Corner radius 30 mm	Internal corner (mitred pair)	External angle (mitred pair) Corner radius 30 mm	Art. no. 55730
55730	55735	55737	55738	55732	55736	Model number
244 x 119 x 15/30 mm	119 x 119 x 15/30	244 x 119 x 15/30	244 x 119 x 15/30	(2x) 112 x 112 x 15/30	(2x) 236 x 119 x 15/30	Nom. dim. - cm
4.000	8.000					Work size mm
1.450/piece	0.700/piece	1.400/piece	1.400/piece	0.700/pair	2.000/pair	m - pieces
12 pieces	24 pieces	12 pieces	12 pieces	24 pairs	6 pairs	Pce./pair - kg
3.000	3.000					Bundle - pce./pair
17.400	16.800	16.800	16.800	16.800	12.000	Bundle - m
						Bundle - kg
						Pallet - m
						Pallet - kg
Alb	Alb	Alb	Alb	Alb	Alb	Product standard
-/C	-/C	-/C	-/C	-/C	-/C	Slip resistance
553001-55730	553001-55735	553001-55737	553001-55738	553001-55732	553001-55736	900 grey-beige
Price gr. A487 (pce.)	Price gr. A452 (pce.)	Price gr. A506 (pce.)	Price gr. A506 (pce.)	Price gr. A547 (pair)	Price gr. A615 (pair)	553001 active azure
553002-55730	553002-55735	553002-55737	553002-55738	553002-55732	553002-55736	900 grey-beige
Price gr. A487 (pce.)	Price gr. A452 (pce.)	Price gr. A506 (pce.)	Price gr. A506 (pce.)	Price gr. A547 (pair)	Price gr. A615 (pair)	553002 light azure
340-55730	340-55735	340-55737	340-55738	340-55732	340-55736	900 grey-beige
Price gr. A487 (pce.)	Price gr. A452 (pce.)	Price gr. A506 (pce.)	Price gr. A506 (pce.)	Price gr. A547 (pair)	Price gr. A615 (pair)	340 n1/black
900567-55730	900567-55735	900567-55737	900567-55738	900567-55732	900567-55736	91 n10/white
Price gr. A511 (pce.)	Price gr. A467 (pce.)	Price gr. A528 (pce.)	Price gr. A528 (pce.)	Price gr. A587 (pair)	Price gr. A645 (pair)	553001 active azure
900588-55730	900588-55735	900588-55737	900588-55738	900588-55732	900588-55736	91 n10/white
Price gr. A511 (pce.)	Price gr. A467 (pce.)	Price gr. A528 (pce.)	Price gr. A528 (pce.)	Price gr. A587 (pair)	Price gr. A645 (pair)	553002 light azure
900044-55730	900044-55735	900044-55737	900044-55738	900044-55732	900044-55736	91 n10/white
Price gr. A511 (pce.)	Price gr. A467 (pce.)	Price gr. A528 (pce.)	Price gr. A528 (pce.)	Price gr. A587 (pair)	Price gr. A645 (pair)	340 n1/black



Handhold-piece (150 mm wide) with non-slip safety marking



Handhold-piece	"Half-size" handhold-piece	Terminal piece left Corner radius 30 mm	Terminal piece right Corner radius 30 mm	Internal corner (mitred pair)	External angle (mitred pair) Corner radius 30 mm	Art. no. 59420
59420	59425	59427	59428	59422	59426	Model number
244 x 150 x 15/30	119 x 150 x 15/30	244 x 150 x 15/30	244 x 150 x 15/30	(2x) 143 x 143 x 15/30	(2x) 236 x 150 x 15/30	Nom. dim. - cm
4.000	8.000					Work size mm
1.600/piece	0.790/piece	1.600/piece	1.600/piece	1.000/pair	2.100/pair	m - pieces
12 pieces	24 pieces	12 pieces	12 pieces	12 pairs	6 pairs	Pce./pair - kg
3.000	3.000					Bundle - pce./pair
19.200	18.960	19.200	19.200	12.000	12.600	Bundle - m
						Bundle - kg
						Pallet - m
						Pallet - kg
Alb	Alb	Alb	Alb	Alb	Alb	Product standard
-/C	-/C	-/C	-/C	-/C	-/C	Slip resistance
553001-59420	553001-59425	553001-59427	553001-59428	553001-59422	553001-59426	900 grey-beige
Price gr. A511 (pce.)	Price gr. A467 (pce.)	Price gr. A528 (pce.)	Price gr. A528 (pce.)	Price gr. A587 (pair)	Price gr. A645 (pair)	553001 active azure
553002-59420	553002-59425	553002-59427	553002-59428	553002-59422	553002-59426	900 grey-beige
Price gr. A511 (pce.)	Price gr. A467 (pce.)	Price gr. A528 (pce.)	Price gr. A528 (pce.)	Price gr. A587 (pair)	Price gr. A645 (pair)	553002 light azure
340-59420	340-59425	340-59427	340-59428	340-59422	340-59426	900 grey-beige
Price gr. A511 (pce.)	Price gr. A467 (pce.)	Price gr. A528 (pce.)	Price gr. A528 (pce.)	Price gr. A587 (pair)	Price gr. A645 (pair)	340 n1/black
900567-59420	900567-59425	900567-59427	900567-59428	900567-59422	900567-59426	91 n10/white
Price gr. A533 (pce.)	Price gr. A487 (pce.)	Price gr. A560 (pce.)	Price gr. A560 (pce.)	Price gr. A618 (pair)	Price gr. A668 (pair)	553001 active azure
900588-59420	900588-59425	900588-59427	900588-59428	900588-59422	900588-59426	91 n10/white
Price gr. A533 (pce.)	Price gr. A487 (pce.)	Price gr. A560 (pce.)	Price gr. A560 (pce.)	Price gr. A618 (pair)	Price gr. A668 (pair)	553002 light azure
900044-59420	900044-59425	900044-59427	900044-59428	900044-59422	900044-59426	91 n10/white
Price gr. A533 (pce.)	Price gr. A487 (pce.)	Price gr. A560 (pce.)	Price gr. A560 (pce.)	Price gr. A618 (pair)	Price gr. A668 (pair)	340 n1/black

¹ For cover gratings, refer to page 454, coved gutter tiles refer to page 443

No pallet rebate is granted for the products shown on this page.

All products: Color Shade Variation V0

The products shown on this page can also be produced in other colors of the series Chroma non-slip. We will be pleased to check the possibility of such a special production upon request.



Handhold-piece and edging tile (140 mm wide) with grating support and non-slip safety marking

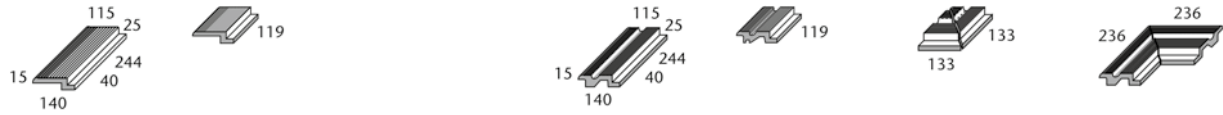

	Edging tile for art. 55760	Edging tile for art. 55765		Handhold-piece	"Half-size" handhold-piece	Internal corner (mitred pair)	External angle (mitred pair) Corner radius 30 mm
Model number	55770	55775		55760	55765	55762	55766
Nom. dim. - cm							
Work size mm	244 x 140 x 15/40	119 x 140 x 15/40		244 x 140 x 15/40	119 x 140 x 15/40	(2x) 133 x 133 x 15/40	(2x) 236 x 140 x 15/40
m - pieces	4.000	8.000		4.000	8.000		
Pce./pair - kg	1.300/piece	0.780/piece		1.550/piece	0.780/piece	1.000/pair	2.300/pair
Bundle - pce./pair	12 pieces	24 pieces		9 pieces	18 pieces	2 pairs	4 pairs
Bundle - m	3.000	3.000		2.250	2.250		
Bundle - kg	15.600	16.720		13.950	14.040	2.000	9.200
Pallet - m							
Pallet - kg							
Product standard	Alb	Alb		Alb	Alb	Alb	Alb
Slip resistance	-/C	-/C		-/C	-/C	-/C	-/C
900 grey-beige	553001-55770	553001-55775		553001-55760	553001-55765	553001-55762	553001-55766
553001 active azure	Price gr. A489 (pce.)	Price gr. A452 (pce.)		Price gr. A556 (pce.)	Price gr. A452 (pce.)	Price gr. A645 (pair)	Price gr. A683 (pair)
900 grey-beige	553002-55770	553002-55775		553002-55760	553002-55765	553002-55762	553002-55766
553002 light azure	Price gr. A489 (pce.)	Price gr. A452 (pce.)		Price gr. A556 (pce.)	Price gr. A452 (pce.)	Price gr. A645 (pair)	Price gr. A683 (pair)
900 grey-beige	340-55770	340-55775		340-55760	340-55765	340-55762	340-55766
340 n1/black	Price gr. A489 (pce.)	Price gr. A452 (pce.)		Price gr. A556 (pce.)	Price gr. A452 (pce.)	Price gr. A645 (pair)	Price gr. A683 (pair)
91 n10/white	900567-55770	900567-55775		900567-55760	900567-55765	900567-55762	900567-55766
553001 active azure	Price gr. A506 (pce.)	Price gr. A463 (pce.)		Price gr. A577 (pce.)	Price gr. A463 (pce.)	Price gr. A668 (pair)	Price gr. A705 (pair)
91 n10/white	900588-55770	900588-55775		900588-55760	900588-55765	900588-55762	900588-55766
553002 light azure	Price gr. A506 (pce.)	Price gr. A463 (pce.)		Price gr. A577 (pce.)	Price gr. A463 (pce.)	Price gr. A668 (pair)	Price gr. A705 (pair)
91 n10/white	900044-55770	900044-55775		900044-55760	900044-55765	900044-55762	900044-55766
340 n1/black	Price gr. A506 (pce.)	Price gr. A463 (pce.)		Price gr. A577 (pce.)	Price gr. A463 (pce.)	Price gr. A668 (pair)	Price gr. A705 (pair)



Edging Tile with non-slip safety marking

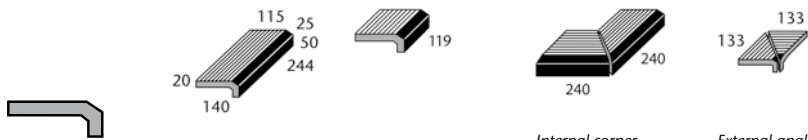

Art. no. 55720

	Edging tile	"Half-size" edging tile	Internal corner (mitred pair)	External angle (mitred pair)			
Model number	55720	55725	55722	55729			
Nom. dim. - cm							
Work size mm	244 x 140 x 20/50	119 x 140 x 20/50	(2x) 240 x 140 x 20/50	(2x) 133 x 133 x 20/50			
m - pieces	4.000	8.000					
Pce./pair - kg	1.500/piece	0.730/piece	2.200/pair	0.700/pair			
Bundle - pce./pair	10 pieces	20 pieces	5 pairs	4 pairs			
Bundle - m	2.500	2.500					
Bundle - kg	15.000	14.600	11.000	2.800			
Pallet - m							
Pallet - kg							
Product standard	Alb	Alb	Alb	Alb			
Slip resistance	-/C	-/C	-/C	-/C			
900 grey-beige	553001-55720	553001-55725	553001-55722	553001-55729			
553001 active azure	Price gr. A528 (pce.)	Price gr. A480 (pce.)	Price gr. A668 (pair)	Price gr. A604 (pair)			
900 grey-beige	553002-55720	553002-55725	553002-55722	553002-55729			
553002 light azure	Price gr. A528 (pce.)	Price gr. A480 (pce.)	Price gr. A668 (pair)	Price gr. A604 (pair)			
900 grey-beige	340-55720	340-55725	340-55722	340-55729			
340 n1/black	Price gr. A528 (pce.)	Price gr. A480 (pce.)	Price gr. A668 (pair)	Price gr. A604 (pair)			
91 n10/white	900567-55720	900567-55725	900567-55722	900567-55729			
553001 active azure	Price gr. A556 (pce.)	Price gr. A506 (pce.)	Price gr. A708 (pair)	Price gr. A636 (pair)			
91 n10/white	900588-55720	900588-55725	900588-55722	900588-55729			
553002 light azure	Price gr. A556 (pce.)	Price gr. A506 (pce.)	Price gr. A708 (pair)	Price gr. A636 (pair)			
91 n10/white	900044-55720	900044-55725	900044-55722	900044-55729			
340 n1/black	Price gr. A556 (pce.)	Price gr. A506 (pce.)	Price gr. A708 (pair)	Price gr. A636 (pair)			



¹ For cover gratings, refer to page 454
No pallet rebate is granted for the products shown on this page.

All products: Color Shade Variation V0

The products shown on this page can also be produced in other colors of the series Chroma non-slip. We will be pleased to check the possibility of such a special production upon request.

Edging tile with grating support and non-slip safety marking

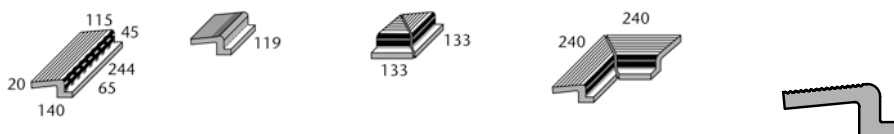

Edging tile	"Half-size" edging tile	Internal corner (mitred pair)	External angle (mitred pair)	Art. no. 55740
55740	55745	55742	55749	Model number
244 x 140 x 20/65	119 x 140 x 20/65	(2x) 133 x 133 x 20/65	(2x) 240 x 140 x 20/65	Nom. dim. - cm
4.000	8.000			Work size mm
1.850/piece	0.900/piece	0.900/pair	2.700/pair	m - pieces
6 pieces	12 pieces	4 pairs	3 pairs	Pce./pair - kg
1.500	1.500			Bundle - pce./pair
11.100	10.800	3.600	8.100	Bundle - m
				Bundle - kg
				Pallet - m
				Pallet - kg
Alb	Alb	Alb	Alb	Product standard
-/C	-/C	-/C	-/C	Slip resistance
553001-55740	553001-55745	553001-55742	553001-55749	900 grey-beige
Price gr. A556 (pce.)	Price gr. A506 (pce.)	Price gr. A645 (pair)	Price gr. A683 (pair)	553001 active azure
553002-55740	553002-55745	553002-55742	553002-55749	900 grey-beige
Price gr. A556 (pce.)	Price gr. A506 (pce.)	Price gr. A645 (pair)	Price gr. A683 (pair)	553002 light azure
340-55740	340-55745	340-55742	340-55749	900 grey-beige
Price gr. A556 (pce.)	Price gr. A506 (pce.)	Price gr. A645 (pair)	Price gr. A683 (pair)	340 n1/black
900567-55740	900567-55745	900567-55742	900567-55749	91 n10/white
Price gr. A577 (pce.)	Price gr. A511 (pce.)	Price gr. A668 (pair)	Price gr. A708 (pair)	553001 active azure
900588-55740	900588-55745	900588-55742	900588-55749	91 n10/white
Price gr. A577 (pce.)	Price gr. A511 (pce.)	Price gr. A668 (pair)	Price gr. A708 (pair)	553002 light azure
900044-55740	900044-55745	900044-55742	900044-55749	91 n10/white
Price gr. A577 (pce.)	Price gr. A511 (pce.)	Price gr. A668 (pair)	Price gr. A708 (pair)	340 n1/black



Edging tile with grating support

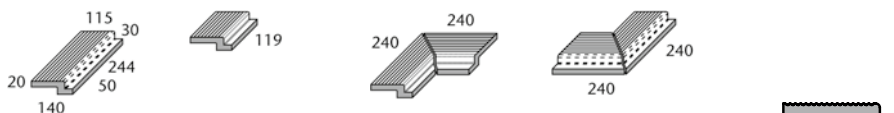

Edging tile	"Half-size" edging tile	Internal corner (mitred pair)	External angle (mitred pair)	Art. no. 55750
55750	55755	55752	55759	Model number
244 x 140 x 20/50	119 x 140 x 20/50	(2x) 240 x 140 x 20/50	(2x) 240 x 140 x 20/50	Nom. dim. - cm
4.000	8.000			Work size mm
1.780/piece	0.880/piece	2.600/pair	2.600/pair	m - pieces
8 pieces	16 pieces	4 pairs	4 pairs	Pce./pair - kg
2.000	2.000			Bundle - pce./pair
14.240	14.080	10.400	10.400	Bundle - m
				Bundle - kg
				Pallet - m
				Pallet - kg
Alb	Alb	Alb	Alb	Product standard
-/C	-/C	-/C	-/C	Slip resistance
900-55750	900-55755	900-55752	900-55759	grey-beige
Price gr. A539 (pce.)	Price gr. A487 (pce.)	Price gr. A663 (pair)	Price gr. A663 (pair)	neutral 10
91-55750	91-55755	91-55752	91-55759	(active white)
Price gr. A560 (pce.)	Price gr. A506 (pce.)	Price gr. A689 (pair)	Price gr. A689 (pair)	

¹ For cover gratings, refer to page 454

No pallet rebate is granted for the products shown on this page.

All products: Color Shade Variation V0



The products shown on this page can also be produced in other colors of the series Chroma non-slip. We will be pleased to check the possibility of such a special production upon request.

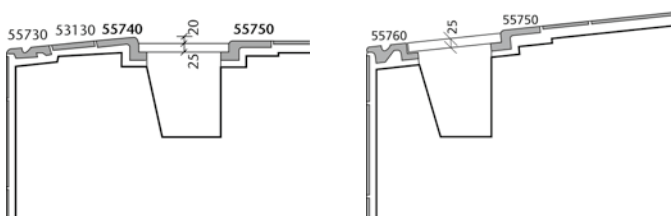





A classic rethought

The further development of the world-wide popular classic Finland (cf. p. 360 ff) is just as universally applicable. An important difference in detail is the inclined grooved tile. Its wedge-shaped longitudinal section decisively facilitates the construction of the concrete structure: the upper side of the pool wall can be executed horizontally. The grooved tile then provides the necessary slope towards the pool. Reduced wave action and the elevated water level ensure increased comfort during swimming and when leaving the pool here, too. The 500 mm long special pieces, which reduce the number of joints, also speak in favour of Finland II. Instead of the standard plastic cover gratings, the use of ceramic channel covers is also possible for private pools (see system Wiesbaden Stil on p. 380 ff).

Finnland II (inclined grooved tile)

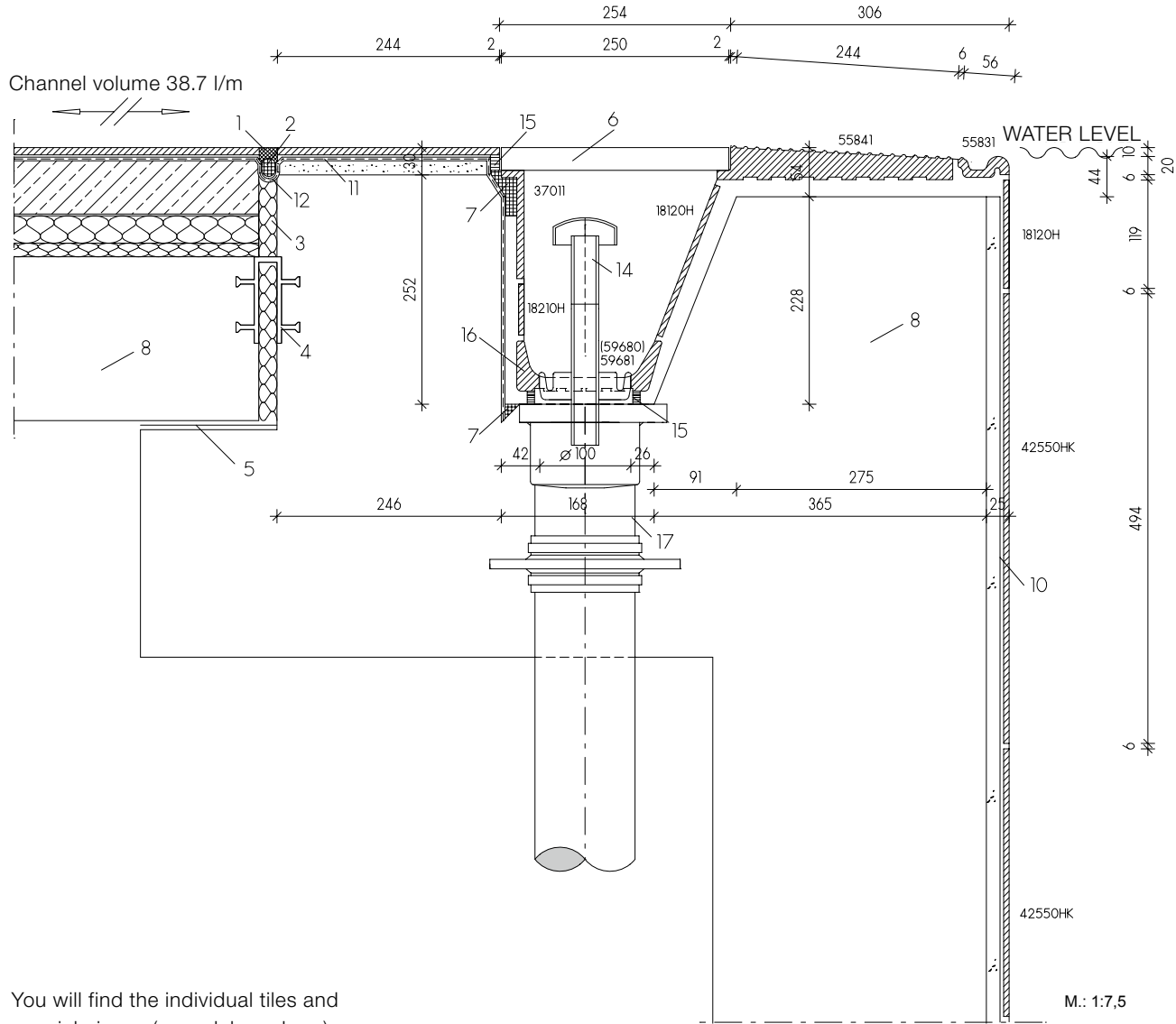

You will find the individual tiles and special pieces (= model numbers) of this system under:

- 42550HK = Chroma tile (page 344 ff)
- 55831 = Handhold-piece (page 377)
- 55841 = inclined overflow channel (page 378)
- 18120H = Chroma tile (page 344 ff)
- 59681 = Coved gutter tile with outlet (page 443)
- 18210H = Chroma strip tile (page 344 ff)
- 37011 = Shank-tile (page 443)
- Cover grating (page 454)
- Outlet valve Silent 100 (page 456)

Legend:

- 01 UW-Silicone
- 02 Closed-cell polyethylene foam round lace
- 03 Elastic water-resistant filling material
- 04 Joint band
- 05 Slide bearing

- 06 Agrob Buchtal plastic cover grating
- 07 Capillary barrier/grouting (reaction resin filler)
- 08 Waterproof concrete (according to DIN EN 206/DIN 1045/DAfStB WU Guideline)
- 09 Conventional thick-bed laying
- 10 Thin-bed laying on cement render (P III, CS IV without added lime)
- 11 Sealing layer
- 12 Sealing tape
- 13 Outlet valve „Silent W 2000“ of Agrob Buchtal
- 14 Air inlet pipe for outlet „Silent 100“
- 15 Epoxi for joints (for the projekt sector)
- 16 Agrob Buchtal section stoneware pipe
- 17 Casing for water inlet/ outlet pipe and brazing collar

Handhold-piece



	Handhold-piece 50 cm	Handhold-piece 25 cm	Handhold-piece 12.5 cm	Internal corner (mitred pair)	External angle (mitred pair) Corner radius 30 mm	Art. no. 55830
	55831	55830	55835	55832	55836	Model number
	494 x 56 x 20/12.5	244 x 56 x 20/12.5	119 x 56 x 20/12.5	(2x) 49 x 49 x 20/12.5	(2x) 236 x 56 x 20/12.5	Nom. dim. - cm
	2.000	4.000	8.000			Work size mm
	0.910/piece	0.450/piece	0.220/piece	0.080/pair	0.790/pair	m - pieces
	8 pieces	28 pieces	56 pieces	18 pairs	14 pairs	Pce./pair - kg
	4.000	7.000	7.000			Bundle - pce./pair
	7.280	12.600	12.320	1.440	11.060	Bundle - m
	Alb	Alb	Alb	Alb	Alb	Bundle - kg
	-/C	-/C	-/C	-/C	-/C	Pallet - m
	553001-55831	553001-55830	553001-55835	553001-55832	553001-55836	Pallet - kg
	Price gr. A514 (pce.)	Price gr. A471 (pce.)	Price gr. A441 (pce.)	Price gr. A519 (pair)	Price gr. A581 (pair)	Product standard
	553002-55831	553002-55830	553002-55835	553002-55832	553002-55836	Slip resistance
	Price gr. A514 (pce.)	Price gr. A471 (pce.)	Price gr. A441 (pce.)	Price gr. A519 (pair)	Price gr. A581 (pair)	
	340-55831	340-55830	340-55835	340-55832	340-55836	active azure
	Price gr. A514 (pce.)	Price gr. A471 (pce.)	Price gr. A441 (pce.)	Price gr. A519 (pair)	Price gr. A581 (pair)	light azure
						neutral 1
						(deep black)



Edging tile, Stair tread

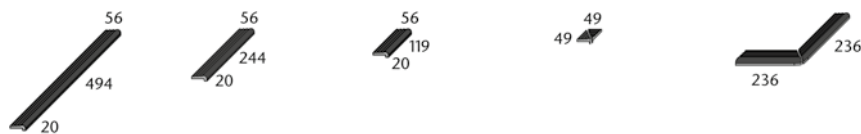

	Edging tile 50 cm	Edging tile 25 cm	Edging tile 12.5 cm	Internal corner (mitred pair)	External angle (mitred pair) Corner radius 30 mm	Art. no. 55820
	55821	55820	55825	55822	55826	Model number
	494 x 56 x 20/12.5	244 x 56 x 20/12.5	119 x 56 x 20/12.5	(2x) 49 x 49 x 20/12.5	(2x) 236 x 56 x 20/12.5	Nom. dim. - cm
	2.000	4.000	8.000			Work size mm
	0.770/piece	0.380/piece	0.190/piece	0.100/pair	0.620/pair	m - pieces
	12 pieces	42 pieces	84 pieces	18 pairs	14 pairs	Pce./pair - kg
	6.000	10.500	10.500			Bundle - pce./pair
	9.240	15.960	15.960	1.440	11.060	Bundle - m
	Alb	Alb	Alb	Alb	Alb	Bundle - kg
	-/C	-/C	-/C	-/C	-/C	Pallet - m
	553001-55821	553001-55820	553001-55825	553001-55822	553001-55826	Pallet - kg
	Price gr. A475 (pce.)	Price gr. A441 (pce.)	Price gr. A425 (pce.)	Price gr. A484 (pair)	Price gr. A528 (pair)	Product standard
	553002-55821	553002-55820	553002-55825	553002-55822	553002-55826	Slip resistance
	Price gr. A475 (pce.)	Price gr. A441 (pce.)	Price gr. A425 (pce.)	Price gr. A484 (pair)	Price gr. A528 (pair)	
	340-55821	340-55820	340-55825	340-55822	340-55826	active azure
	Price gr. A475 (pce.)	Price gr. A441 (pce.)	Price gr. A425 (pce.)	Price gr. A484 (pair)	Price gr. A528 (pair)	light azure
						neutral 1
						(deep black)



¹ For cover gratings, refer to page 454, for the coved gutter tiles refer to page 443

No pallet rebate is granted for the products shown on this page.

All products: Color Shade Variation V0

 The products shown on this page can also be produced in other colors of the series Chroma non-slip. We will be pleased to check the possibility of such a special production upon request.

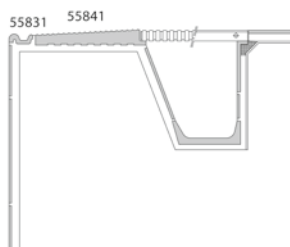

Inclined grooved tile for continuing the Pool Edge System "Finland II"²

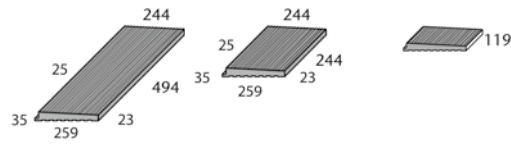

Grooved Tiles 12.5 mm thick, for continuing the Pool Edge System "Finland II"²

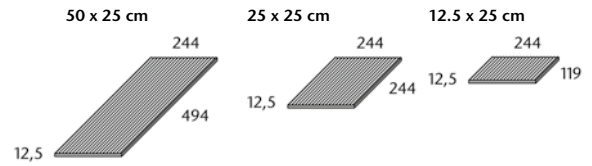

	grooved 50 cm	grooved 25 cm	grooved 12.5 cm	grooved	grooved	grooved
Model number	55841	55840	55845	53151	53150	53159
Nom. dim. - cm/in				50 x 25 / 20 x 10	25 x 25 / 10 x 10	12.5 x 25 / 5 x 10
Work size mm	494 x 244 x 23/35	244 x 244 x 23/35	119 x 244 x 23/35	494 x 244 x 12.5	244 x 244 x 12.5	119 x 244 x 12.5
m - pieces	2.000	4.000	8.000	2.000	4.000	8.000
Pieces - kg	8.100	3.950	1.930	3.550	1.775	0.888
Bundle - pieces	2	6	12	6	9	21
Bundle - m	1.000	1.500	1.500	3.000	2.250	2.625
Bundle - kg	16.200	23.700	37.306	21.300	15.975	18.648
Product standard	Alb	Alb	Alb	Alb	Alb	Alb
Slip resistance	-/C	-/C	-/C	see below	see below	see below
grey-beige ⁵	900-55841⁴ Price gr. A638 (pce.)	900-55840⁴ Price gr. A556 (pce.)	900-55845⁴ Price gr. A506 (pce.)	-/C 900-53151⁴ Price gr. A463 (pce.)	-/C 900-53150⁴ Price gr. A430 (pce.)	-/C 900-53159⁴ Price gr. A410 (pce.)
neutral 10 (active white) ⁵	91-55841 Price gr. A663 (pce.)	91-55840 Price gr. A573 (pce.)	91-55845 Price gr. A511 (pce.)	-/C 91-53151 Price gr. A528 (pce.)	-/C 91-53150 Price gr. A465 (pce.)	-/C 91-53159 Price gr. A423 (pce.)
active azure ⁵	553001-55841 Price gr. A683 (pce.)	553001-55840 Price gr. A587 (pce.)	553001-55845 Price gr. A519 (pce.)	-/C 553001-53151 Price gr. A545 (pce.)	-/C 553001-53150 Price gr. A471 (pce.)	-/C 553001-53159 Price gr. A426 (pce.)
light azure ⁵	553002-55841 Price gr. A683 (pce.)	553002-55840 Price gr. A587 (pce.)	553002-55845 Price gr. A519 (pce.)	-/C 553002-53151 Price gr. A545 (pce.)	-/C 553002-53150 Price gr. A471 (pce.)	-/C 553002-53159 Price gr. A426 (pce.)
neutral 1 (deep black) ⁵	340-55841 Price gr. A683 (pce.)	340-55840 Price gr. A587 (pce.)	340-55845 Price gr. A519 (pce.)	-/C 340-53151 Price gr. A545 (pce.)	-/C 340-53150 Price gr. A471 (pce.)	-/C 340-53159 Price gr. A426 (pce.)
Area Pro anthracite ⁶ NEW				R11/C 435601H^{3/4} Price gr. A560 (pce.)	R11/C 435613H^{3/4} Price gr. A480 (pce.)	R11/C 435625H^{3/4} Price gr. A430 (pce.)
Area Pro basalt ⁶ NEW				R11/C 435602H^{3/4} Price gr. A560 (pce.)	R11/C 435614H^{3/4} Price gr. A480 (pce.)	R11/C 435626H^{3/4} Price gr. A430 (pce.)
Area Pro pebble ⁶ NEW				R11/C 435603H^{3/4} Price gr. A560 (pce.)	R11/C 435615H^{3/4} Price gr. A480 (pce.)	R11/C 435627H^{3/4} Price gr. A430 (pce.)
Area Pro stone ⁶ NEW				R11/C 435604H^{3/4} Price gr. A560 (pce.)	R11/C 435616H^{3/4} Price gr. A480 (pce.)	R11/C 435628H^{3/4} Price gr. A430 (pce.)
Area Pro sand-white ⁶ NEW				R11/C 435605H^{3/4} Price gr. A560 (pce.)	R11/C 435617H^{3/4} Price gr. A480 (pce.)	R11/C 435629H^{3/4} Price gr. A430 (pce.)
Area Pro sand-grey ⁶ NEW				R11/C 435606H^{3/4} Price gr. A560 (pce.)	R11/C 435618H^{3/4} Price gr. A480 (pce.)	R11/C 435630H^{3/4} Price gr. A430 (pce.)
Area Pro sand ⁶ NEW				R11/C 435607H^{3/4} Price gr. A560 (pce.)	R11/C 435619H^{3/4} Price gr. A480 (pce.)	R11/C 435631H^{3/4} Price gr. A430 (pce.)
Area Pro nutmeg ⁶ NEW				R11/C 435608H^{3/4} Price gr. A560 (pce.)	R11/C 435620H^{3/4} Price gr. A480 (pce.)	R11/C 435632H^{3/4} Price gr. A430 (pce.)
Area Pro platinum ⁶ NEW				R11/C 435609H^{3/4} Price gr. A560 (pce.)	R11/C 435621H^{3/4} Price gr. A480 (pce.)	R11/C 435633H^{3/4} Price gr. A430 (pce.)
Area Pro sand-beige ⁶ NEW				R11/C 435610H^{3/4} Price gr. A560 (pce.)	R11/C 435622H^{3/4} Price gr. A480 (pce.)	R11/C 435634H^{3/4} Price gr. A430 (pce.)
Area Pro brick ⁶ NEW				R11/C 435611H^{3/4} Price gr. A560 (pce.)	R11/C 435623H^{3/4} Price gr. A480 (pce.)	R11/C 435635H^{3/4} Price gr. A430 (pce.)
Area Pro clay ⁶ NEW				R11/C 435612H^{3/4} Price gr. A560 (pce.)	R11/C 435624H^{3/4} Price gr. A480 (pce.)	R11/C 435636H^{3/4} Price gr. A430 (pce.)

 The products shown on this page can also be produced in other colors of the series Chroma non-slip. We will be pleased to check the possibility of such a special production upon request.



¹ For cover gratings, refer to page 454, covered gutter tiles refer to page 443

² Short edge rectified 



³ Make-to-order production: return and/or cancellation of ordered products not possible.

⁴ These articles comply with DIN EN 14411, group Al_b, unglazed (UGL)

⁵ Color Shade Variation: V0

⁶ All products of the series Area Pro: Color Shade Variation V2

No pallet rebate is granted for the products shown on this page.

Grooved Tiles 12.5 mm thick,
for continuing the Pool Edge System
"Finland II"^{2/3}

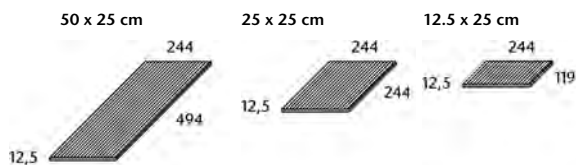

	grooved	grooved	grooved	
	53151	53150	53159	Model number
	50 x 25 / 20 x 10	25 x 25 / 10 x 10	12.5 x 25 / 5 x 10	Nom. dim. - cm/in
	494 x 244 x 12.5	244 x 244 x 12.5	119 x 244 x 12.5	Work size mm
	2.000	4.000	8.000	m - pieces
	3.550	1.775	0.888	Pieces - kg
	6	9	21	Bundle - pieces
	3.000	2.250	2.625	Bundle - m
	21.300	15.975	18.648	Bundle - kg
				Pallet - m
				Pallet - kg
	Alb	Alb	Alb	Product standard
	R11/C	R11/C	R11/C	Slip resistance
	430789H	430793H	430802H	Ascona
	Price gr. A560 (pce.)	Price gr. A480 (pce.)	Price gr. A430 (pce.)	pearl ⁴
	430790H	430794H	430803H	Ascona
	Price gr. A560 (pce.)	Price gr. A480 (pce.)	Price gr. A430 (pce.)	mud ⁴
	430791H	430795H	430804H	Ascona
	Price gr. A560 (pce.)	Price gr. A480 (pce.)	Price gr. A430 (pce.)	stone ⁴
	430792H	430796H	430805H	Ascona
	Price gr. A560 (pce.)	Price gr. A480 (pce.)	Price gr. A430 (pce.)	graphite ⁴
	431551H	431553H	431555H	Ascona
	Price gr. A560 (pce.)	Price gr. A480 (pce.)	Price gr. A430 (pce.)	shell ⁴
	431552H	431554H	431556H	Ascona
	Price gr. A560 (pce.)	Price gr. A480 (pce.)	Price gr. A430 (pce.)	sand ⁴
	8460-53151	8460-53150	8460-53159	Quarzit
	Price gr. A560 (pce.)	Price gr. A480 (pce.)	Price gr. A430 (pce.)	basalt-grey ⁵
	8461-53151	8461-53150	8461-53159	Quarzit
	Price gr. A560 (pce.)	Price gr. A480 (pce.)	Price gr. A430 (pce.)	quartz-grey ⁵
	8462-53151	8462-53150	8462-53159	Quarzit
	Price gr. A560 (pce.)	Price gr. A480 (pce.)	Price gr. A430 (pce.)	sand-beige ⁵
	8463-53151	8463-53150	8463-53159	Quarzit
	Price gr. A560 (pce.)	Price gr. A480 (pce.)	Price gr. A430 (pce.)	sepia-brown ⁵
	8464-53151	8464-53150	8464-53159	Quarzit
	Price gr. A560 (pce.)	Price gr. A480 (pce.)	Price gr. A430 (pce.)	white-grey ⁵

¹ For cover gratings, refer to page 454, coved gutter tiles refer to page 443

²  Short edge rectified

³  Make-to-order production: return and/or cancellation of ordered products not possible.

⁴ All products of the series Ascona: Color Shade Variation V3

⁵ All products of the series Quarzit: Color Shade Variation V4

No pallet rebate is granted for the products shown on this page.



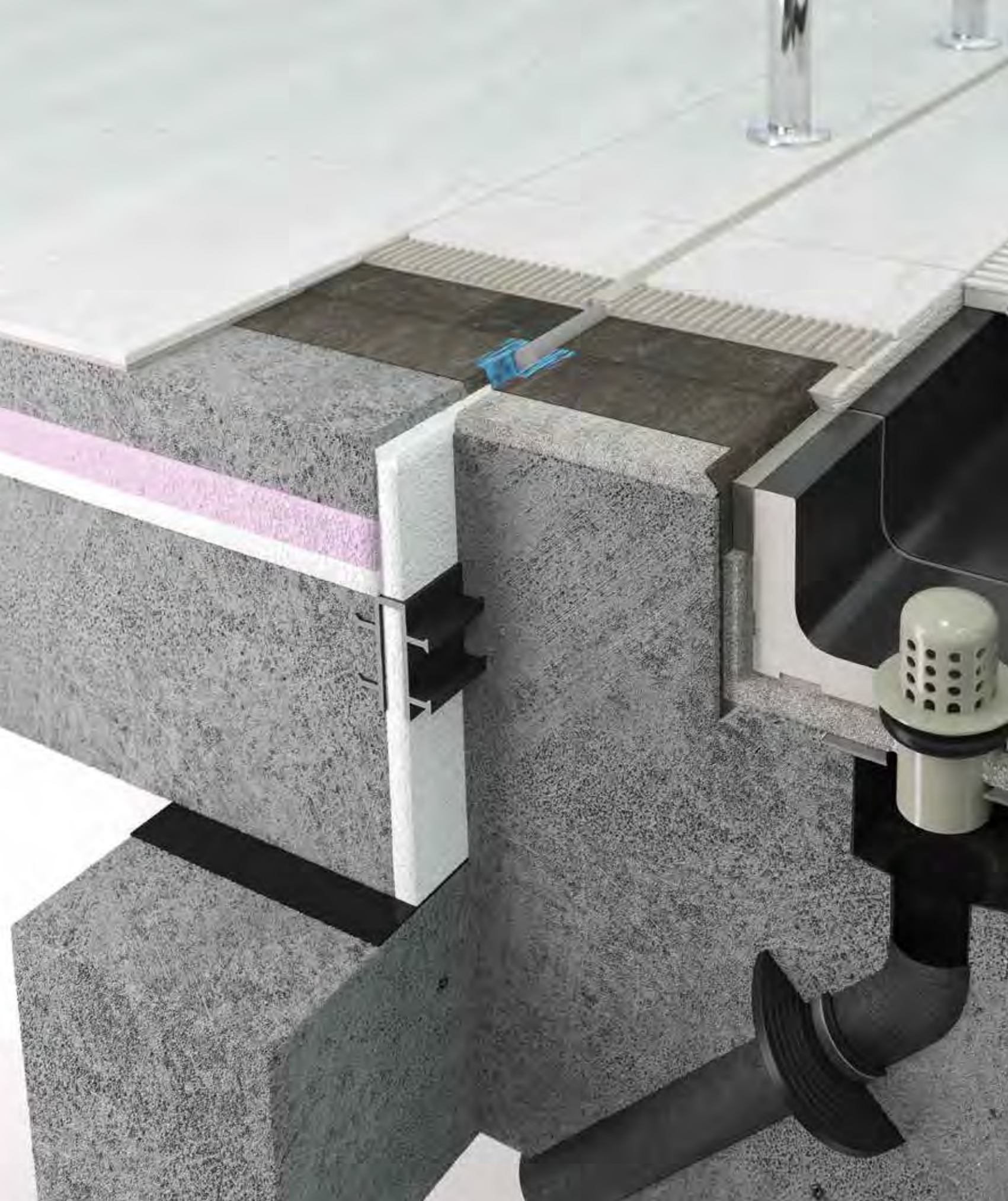

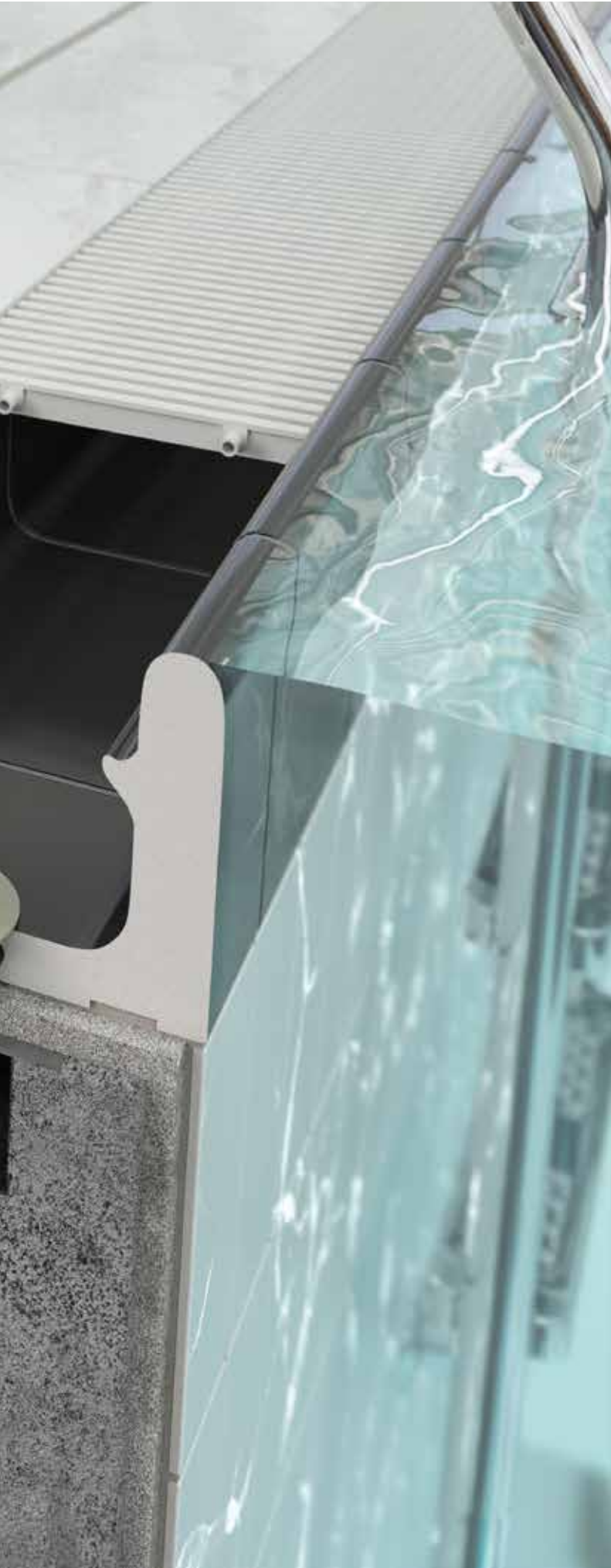

Whispering specialists

With four different versions, the Wiesbaden system also meets special requirements, for example for therapy pools or flow channels. Equipped with the outlet valve Silent W 2000, Wiesbaden audibly reduces the noise level in indoor swimming pools.

Pool edge system Wiesbaden with elevated water level

Proven in leisure and adventure pools as well as in thermal and open-air pools, this system is convincing, among other things, because of its rational design. The large overflow channel combines all requirements in a single construction element: overflow edge, handhold-piece and channel. This saves time and money in pool construction. Like all Agrob Buchtal pool edge systems, the Wiesbaden overflow channel is manufactured without cavities and is therefore particularly robust.

Wiesbaden with elevated water level

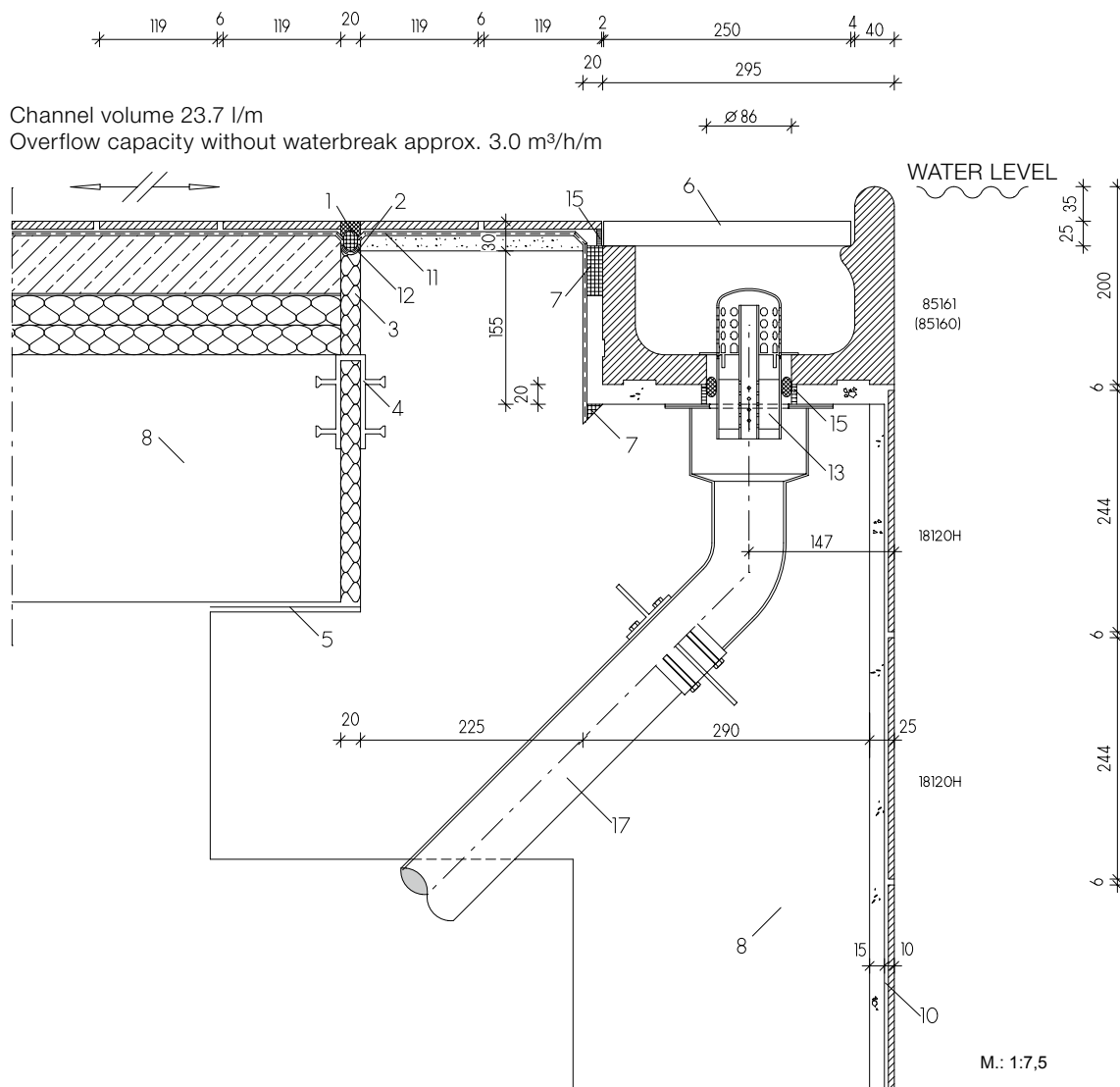

You will find the individual tiles and special pieces (= model numbers) of this system under:

18120H = Chroma tile (page 344 ff)
85160 = Overflow channel (page 383)
85161 = Overflow channel with outlet (page 383)
Cover grating (page 454)
Outlet valve Silent W 2000 (page 456)

Legend:

01 UW-Silicone
02 Closed-cell polyethylene foam round lace
03 Elastic water-resistant filling material
04 Joint band
05 Slide bearing
06 Agrob Buchtal plastic cover grating

07 Capillary barrier/grouting (reaction resin filler)
08 Waterproof concrete (according to DIN EN 206/DIN 1045/DAfStB WU Guideline)
09 Conventional thick-bed laying
10 Thin-bed laying on cement render (P III, CS IV without added lime)
11 Sealing layer
12 Sealing tape
13 Outlet valve „Silent W 2000“ of Agrob Buchtal
14 Air inlet pipe for outlet „Silent 100“
15 Epoxi for joints (for the projekt sector)
16 Agrob Buchtal section stoneware pipe
17 Casing for water inlet/ outlet pipe and brazing collar

Large Channel

(Cover grating width 250 mm, see page 454)



Overflow channel ¹	"Half-size" overflow channel	Outlet (Ø 86 mm) ^{2/3}	Outlet (Ø 86 mm) ²	Terminal inlay left/terminal inlay right	Internal corner (mitred pair, 4 parts)	External angle (mitred pair, 4 parts) Corner radius 30 mm	Art. no. 85160
85160	85165	85161	85163	85167/85168	S85162	85166	Model number
244 x 295 x 200/140	119 x 295 x 200/140	244 x 295 x 200/140	119 x 295 x 200/140	dim. as channel	(2x)414/119x295x200/140	(2x) 486 x 295 x 200/140	Nom. dim. - cm
4.000	8.000						Work size mm
10.300/piece	5.000/piece	10.000/piece	4.700/piece	0.300/piece	20.500/pair	30.000/pair	m - pieces
1 piece	2 pieces	1 piece	2 pieces		1 pair	1 pair	Pce./pair - kg
0.250	0.250						Bundle - pce./pair
10.300	10.000	10.000	9.400		20.500	30.000	Bundle - m
							Bundle - kg
							Pallet - m
							Pallet - kg
Alb	Alb	Alb	Alb	Alb	Alb	Alb	Product standard
700-85160	700-85165	700-85161	700-85163	700-85167/68	700-S85162	700-85166	neutral 10
Price gr. A649 (pce.)	Price gr. A581 (pce.)	Price gr. A668 (pce.)	Price gr. A625 (pce.)	Price gr. A484 (pce.)	Price gr. A792 (pair)	Price gr. A792 (pair)	(active white glossy)
701-85160	701-85165	701-85161	701-85163	701-85167/68	701-S85162	701-85166	neutral 10
Price gr. A649 (pce.)	Price gr. A581 (pce.)	Price gr. A668 (pce.)	Price gr. A625 (pce.)	Price gr. A484 (pce.)	Price gr. A792 (pair)	Price gr. A792 (pair)	(active white matt)
552001-85160	552001-85165	552001-85161	552001-85163	552001-85167/68	552001-S85162	552001-85166	active azure
Price gr. A654 (pce.)	Price gr. A683 (pce.)	Price gr. A683 (pce.)	Price gr. A629 (pce.)	Price gr. A489 (pce.)	Price gr. A800 (pair)	Price gr. A800 (pair)	
552002-85160	552002-85165	552002-85161	552002-85163	552002-85167/68	552002-S85162	552002-85166	light azure
Price gr. A654 (pce.)	Price gr. A587 (pce.)	Price gr. A683 (pce.)	Price gr. A629 (pce.)	Price gr. A489 (pce.)	Price gr. A800 (pair)	Price gr. A800 (pair)	neutral 1
5716-85160⁴	5716-85165⁴	5716-85161⁴	5716-85163⁴	5716-85167/68⁴	5716-S85162⁴	5716-85166⁴	neutral 1
Price gr. A654 (pce.)	Price gr. A587 (pce.)	Price gr. A683 (pce.)	Price gr. A629 (pce.)	Price gr. A489 (pce.)	Price gr. A800 (pair)	Price gr. A800 (pair)	(deep black)

¹ Also available with rounded front edge for areas provided for ladders.

² For the matching outlet valve "Silent W 2000", refer to page 456

³ Model 85161 also available with outlet Ø 100 mm (=model 551312)

⁴ For reasons of production, differences in color between special pieces and standard tiles can occur.



Small Channel

(Cover grating width 191 mm, see page 454)

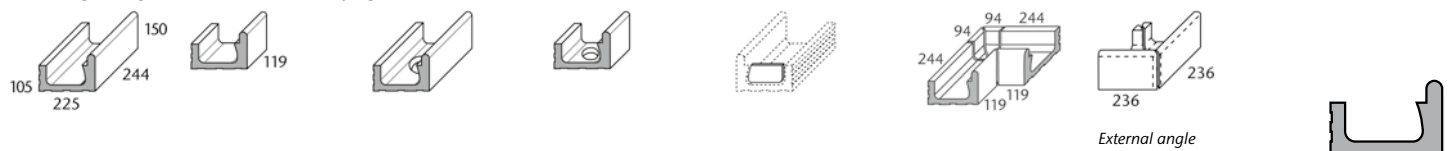

Overflow channel	"Half-size" overflow channel	Outlet (Ø 86 mm) ²	Outlet (Ø 86 mm) ²	Terminal inlay left/terminal inlay right	Internal corner (mitred pair, 4 parts)	External angle (mitred pair) Corner radius 30 mm	Art. no. 55180
55180	55185	55181	S50044	55187/55188	S55182	55186	Model number
244 x 225 x 150/105	119 x 225 x 150/105	244 x 225 x 150/105	119 x 225 x 150/105	dim. as channel	(2x)344/119x225x150/105	(2x) 236x225x150/105	Nom. dim. - cm
4.000	8.000						Work size mm
7.000/piece	3.425/piece	6.600/piece	3.100/piece	0.200/piece	11.800/pair	8.300/pair	m - pieces
1 piece	2 pieces	1 piece	2 pieces		1 pair	1 pair	Pce./pair - kg
0.250	0.250						Bundle - pce./pair
7.000	6.860	6.600	6.200		11.800	8.300	Bundle - m
							Bundle - kg
							Pallet - m
							Pallet - kg
Alb	Alb	Alb	Alb	Alb	Alb	Alb	Product standard
700-55180	700-55185	700-55181	700-S50044	700-55187/88	700-S55182	700-55186	neutral 10
Price gr. A615 (pce.)	Price gr. A547 (pce.)	Price gr. A645 (pce.)	Price gr. A601 (pce.)	Price gr. A487 (pce.)	Price gr. A723 (pair)	Price gr. A723 (pair)	(active white glossy)
701-55180	701-55185	701-55181	701-S50044	701-55187/88	701-S55182	701-55186	neutral 10
Price gr. A615 (pce.)	Price gr. A547 (pce.)	Price gr. A645 (pce.)	Price gr. A601 (pce.)	Price gr. A487 (pce.)	Price gr. A723 (pair)	Price gr. A723 (pair)	(active white matt)
552001-55180	552001-55185	552001-55181	552001-S50044	552001-55187/88	552001-S55182	552001-55186	active azure
Price gr. A618 (pce.)	Price gr. A556 (pce.)	Price gr. A654 (pce.)	Price gr. A608 (pce.)	Price gr. A489 (pce.)	Price gr. A731 (pair)	Price gr. A731 (pair)	
552002-55180	552002-55185	552002-55181	552002-S50044	552002-55187/88	552002-S55182	552002-55186	light azure
Price gr. A618 (pce.)	Price gr. A556 (pce.)	Price gr. A654 (pce.)	Price gr. A608 (pce.)	Price gr. A489 (pce.)	Price gr. A731 (pair)	Price gr. A731 (pair)	neutral 1
5716-55180⁴	5716-55185⁴	5716-55181⁴	5716-S50044⁴	5716-55187/88⁴	5716-S55182⁴	5716-55186⁴	neutral 1
Price gr. A618 (pce.)	Price gr. A556 (pce.)	Price gr. A654 (pce.)	Price gr. A608 (pce.)	Price gr. A489 (pce.)	Price gr. A731 (pair)	Price gr. A731 (pair)	(deep black)

² For the matching outlet valve "Silent W 2000", refer to page 456

⁴ For reasons of production, differences in color between special pieces and standard tiles can occur.



The products shown on this page can also be produced in other colors of the series Chroma. We will be pleased to check the possibility of such a special production upon request.

Conic cuts for the products shown on this page are possible upon request. No pallet rebate is granted for the products shown on this page.

All products: Color Shade Variation V0

Wiesbaden Silent

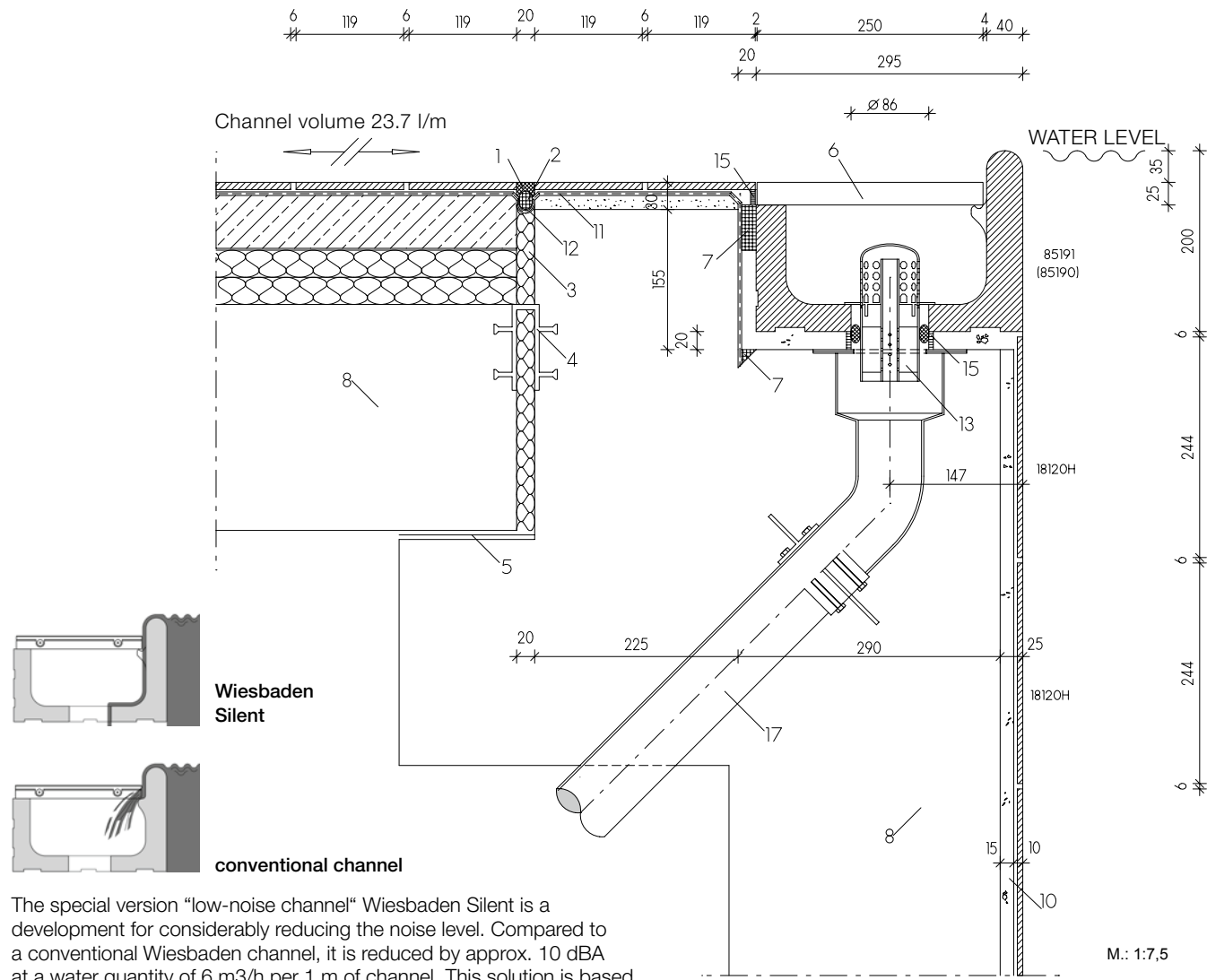

The special version "low-noise channel" Wiesbaden Silent is a development for considerably reducing the noise level. Compared to a conventional Wiesbaden channel, it is reduced by approx. 10 dBA at a water quantity of 6 m³/h per 1 m of channel. This solution is based on a complex combination of channel shape, arrangement of cover gratings and specially designed supporting strip for the gratings.

You will find the individual tiles and special pieces (= model numbers) of this system under:

- 18120H = Chroma tile (page 344 ff)
- 85160 = Overflow channel (page 383)
- 85161 = Overflow channel with outlet (page 383)
- Cover grating (page 454)
- Outlet valve Silent W 2000 (page 456)

Legend:

- 01 UW-Silicone
- 02 Closed-cell polyethylene foam round lace
- 03 Elastic water-resistant filling material
- 04 Joint band
- 05 Slide bearing
- 06 Agrob Buchtal plastic cover grating

- 07 Capillary barrier/grouting (reaction resin filler)
- 08 Waterproof concrete (according to DIN EN 206/DIN 1045/DAfStB WU Guideline)
- 09 Conventional thick-bed laying
- 10 Thin-bed laying on cement render (P III, CS IV without added lime)
- 11 Sealing layer
- 12 Sealing tape
- 13 Outlet valve „Silent W 2000“ of Agrob Buchtal
- 14 Air inlet pipe for outlet „Silent 100“
- 15 Epoxi for joints (for the projekt sector)
- 16 Agrob Buchtal section stoneware pipe
- 17 Casing for water inlet/ outlet pipe and brazing collar

Large “Low-Noise Channel”

(only transverse gratings with a width of 250 mm can be used, see page 454)



Overflow channel ¹	“Half-size” overflow channel	Outlet (Ø 86 mm) ^{2/3}	Outlet (Ø 86 mm) ²	Terminal inlay left/ terminal inlay right	Internal corner (mitred pair, 4 parts)	External angle (mitred pair, 4 parts) Corner radius 30 mm	Art. no. 85190
85190	85195	85191	85193	85197/85198	S85192	85196	Model number
244 x 295 x 200/140	119 x 295 x 200/140	244 x 295 x 200/140	119 x 295 x 200/140	dim. as channel	(2x)414/119x295x200/140	(2x) 486 x 295 x 200/140	Nom. dim. - cm
4.000	8.000						Work size mm
10.400/piece	5.100/piece	10.100/piece	4.800/piece	0.300/piece	20.800/pair	30.400/pair	m - pieces
1 piece	2 pieces	1 piece	2 pieces		1 pair	1 pair	Pce./pair - kg
0.250	0.250						Bundle - pce./pair
10.400	10.200	10.100	9.600		20.800	30.400	Bundle - m
							Bundle - kg
							Pallet - m
							Pallet - kg
Alb	Alb	Alb	Alb	Alb	Alb	Alb	Product standard
700-85190	700-85195	700-85191	700-85193	700-85197/98	700-S85192	700-85196	neutral 10
Price gr. A715 (pce.)	Price gr. A638 (pce.)	Price gr. A734 (pce.)	Price gr. A689 (pce.)	Price gr. A539 (pce.)	Price gr. A814 (pair)	Price gr. A814 (pair)	(active white glossy)
701-85190	701-85195	701-85191	701-85193	701-85197/98	701-S85192	701-85196	neutral 10
Price gr. A715 (pce.)	Price gr. A638 (pce.)	Price gr. A734 (pce.)	Price gr. A689 (pce.)	Price gr. A539 (pce.)	Price gr. A814 (pair)	Price gr. A814 (pair)	(active white matt)
552001-85190	552001-85195	552001-85191	552001-85193	552001-85197/98	552001-S85192	552001-85196	active azure
Price gr. A716 (pce.)	Price gr. A645 (pce.)	Price gr. A741 (pce.)	Price gr. A698 (pce.)	Price gr. A545 (pce.)	Price gr. A816 (pair)	Price gr. A816 (pair)	
552002-85190	552002-85195	552002-85191	552002-85193	552002-85197/98	552002-S85192	552002-85196	light azure
Price gr. A716 (pce.)	Price gr. A645 (pce.)	Price gr. A741 (pce.)	Price gr. A698 (pce.)	Price gr. A545 (pce.)	Price gr. A816 (pair)	Price gr. A816 (pair)	neutral 1
5716-85190⁴	5716-85195⁴	5716-85191⁴	5716-85193⁴	5716-85197/98⁴	5716-S85192⁴	5716-85196⁴	(deep black)
Price gr. A716 (pce.)	Price gr. A645 (pce.)	Price gr. A741 (pce.)	Price gr. A698 (pce.)	Price gr. A545 (pce.)	Price gr. A816 (pair)	Price gr. A816 (pair)	

¹ Also available with rounded front edge for areas provided for ladders.

² For the matching outlet valve “Silent W 2000”, refer to page 456

³ Model 85191 also available with outlet Ø 100 mm. (= model S51325)

⁴ For reasons of production, differences in color between special pieces and standard tiles can occur.



Small “Low-Noise Channel”

(only transverse gratings with a width of 191 mm can be used, see page 454)



Overflow channel	“Half-size” overflow channel	Outlet (Ø 86 mm) ²	Outlet (Ø 86 mm) ²	Terminal inlay left/ terminal inlay right	Internal corner (mitred pair, 4 parts)	External angle (mitred pair) Corner radius 30 mm	Art. no. 85180
85180	85185	85181	85183	85187/85188	S85182	85186	Model number
244 x 225 x 150/105	119 x 225 x 150/105	244 x 225 x 150/105	119 x 225 x 150/105	dim. as channel	(2x)344/119x225x150/105	(2x) 236 x 225 x 150/105	Nom. dim. - cm
4.000	8.000						Work size mm
7.000/piece	3.430/piece	6.600/piece	3.100/piece	0.200/piece	11.800/pair	8.300/pair	m - pieces
1 piece	2 pieces	1 piece	2 pieces		1 pair	1 pair	Pce./pair - kg
0.250	0.250						Bundle - pce./pair
7.000	6.860	6.600	6.200		11.800	8.300	Bundle - m
							Bundle - kg
							Pallet - m
							Pallet - kg
Alb	Alb	Alb	Alb	Alb	Alb	Alb	Product standard
700-85180	700-85185	700-85181	700-85183	700-85187/88	700-S85182	700-85186	neutral 10
Price gr. A649 (pce.)	Price gr. A581 (pce.)	Price gr. A683 (pce.)	Price gr. A638 (pce.)	Price gr. A511 (pce.)	Price gr. A757 (pair)	Price gr. A757 (pair)	(active white glossy)
701-85180	701-85185	701-85181	701-85183	701-85187/88	701-S85182	701-85186	neutral 10
Price gr. A649 (pce.)	Price gr. A581 (pce.)	Price gr. A683 (pce.)	Price gr. A638 (pce.)	Price gr. A511 (pce.)	Price gr. A757 (pair)	Price gr. A757 (pair)	(active white matt)
552001-85180	552001-85185	552001-85181	552001-85183	552001-85187/88	552001-S85182	552001-85186	active azure
Price gr. A654 (pce.)	Price gr. A587 (pce.)	Price gr. A698 (pce.)	Price gr. A645 (pce.)	Price gr. A514 (pce.)	Price gr. A766 (pair)	Price gr. A766 (pair)	
552002-85180	552002-85185	552002-85181	552002-85183	552002-85187/88	552002-S85182	552002-85186	light azure
Price gr. A654 (pce.)	Price gr. A587 (pce.)	Price gr. A698 (pce.)	Price gr. A645 (pce.)	Price gr. A514 (pce.)	Price gr. A766 (pair)	Price gr. A766 (pair)	neutral 1
5716-85180⁴	5716-85185⁴	5716-85181⁴	5716-85183⁴	5716-85187/88⁴	5716-S85182⁴	5716-85186⁴	(deep black)
Price gr. A654 (pce.)	Price gr. A587 (pce.)	Price gr. A698 (pce.)	Price gr. A645 (pce.)	Price gr. A514 (pce.)	Price gr. A766 (pair)	Price gr. A766 (pair)	

² For the matching outlet valve “Silent W 2000”, refer to page 456

⁴ For reasons of production, differences in color between special pieces and standard tiles can occur.

Conic cuts for the products shown on this page are possible upon request.

No pallet rebate is granted for the products shown on this page.

All products: Color Shade Variation V0

 The products shown on this page can also be produced in other colors of the series Chroma. We will be pleased to check the possibility of such a special production upon request.





Large Channel (also available as low-noise channel Wiesbaden Silent = model 95190 upon request)
(Cover grating width 250 mm, see page 454)



Overflow channel	"Half-size" overflow channel	Outlet (Ø 86 mm) ¹	Outlet (Ø 86 mm) ¹	Terminal inlay left/terminal inlay right	Internal corner (mitred pair, 4 parts)	External angle (mitred pair, 4 parts) Corner radius 30 mm	Art. no. 95160
95160	95165	95161	95163	85167/85168	S95162	95166	Model number
244 x 295 x 200/140	119 x 295 x 200/140	244 x 295 x 200/140	119 x 295 x 200/140	dim. as channel	(2x) 414/119x295x200/140	(2x) 486 x 295 x 200/140	Nom. dim. - cm
4.000	8.000						Work size mm
9.800/piece	4.900/piece	9.500/piece	4.750/piece	0.300/piece	20.200/pair	29.200/pair	m - pieces
1 piece	2 pieces	1 piece	2 pieces		1 pair	1 pair	Pce./pair - kg
0.250	0.250						Bundle - pce./pair
9.800	9.800	9.500	9.500		20.200	29.200	Bundle - m
							Bundle - kg
							Pallet - m
							Pallet - kg
Alb	Alb	Alb	Alb	Alb	Alb	Alb	Product standard
700-95160	700-95165	700-95161	700-95163	700-85167/68	700-S95162	700-95166	neutral 10
Price gr. A663 (pce.)	Price gr. A593 (pce.)	Price gr. A683 (pce.)	Price gr. A638 (pce.)	Price gr. A484 (pce.)	Price gr. A799 (pair)	Price gr. A799 (pair)	(active white glossy)
701-95160	701-95165	701-95161	701-95163	701-85167/68	701-S95162	701-95166	neutral 10
Price gr. A663 (pce.)	Price gr. A593 (pce.)	Price gr. A683 (pce.)	Price gr. A638 (pce.)	Price gr. A484 (pce.)	Price gr. A799 (pair)	Price gr. A799 (pair)	(active white matt)
552001-95160	552001-95165	552001-95161	552001-95163	552001-85167/68	552001-S95162	552001-95166	active azure
Price gr. A668 (pce.)	Price gr. A600 (pce.)	Price gr. A698 (pce.)	Price gr. A645 (pce.)	Price gr. A489 (pce.)	Price gr. A804 (pair)	Price gr. A804 (pair)	
552002-95160	552002-95165	552002-95161	552002-95163	552002-85167/68	552002-S95162	552002-95166	light azure
Price gr. A668 (pce.)	Price gr. A600 (pce.)	Price gr. A698 (pce.)	Price gr. A645 (pce.)	Price gr. A489 (pce.)	Price gr. A804 (pair)	Price gr. A804 (pair)	neutral 1
5716-95160³	5716-95165³	5716-95161³	5716-95163³	5716-85167/68³	5716-S95162³	5716-95166³	(deep black)
Price gr. A668 (pce.)	Price gr. A600 (pce.)	Price gr. A698 (pce.)	Price gr. A645 (pce.)	Price gr. A489 (pce.)	Price gr. A804 (pair)	Price gr. A804 (pair)	

¹ For the matching outlet valve "Silent W 2000", refer to page 456
² Matching mosaic: see series Plural
³ For reasons of production, differences in color between special pieces and standard tiles can occur.



Small Channel (also available as low-noise channel Wiesbaden Silent = model 96180 upon request)
(Cover grating width 191 mm, see page 454)

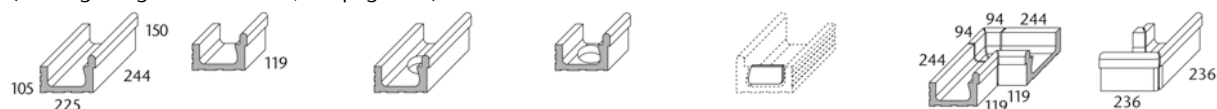

Overflow channel	"Half-size" overflow channel	Outlet (Ø 86 mm) ¹	Outlet (Ø 86 mm) ¹	Terminal inlay left/terminal inlay right	Internal corner (mitred pair, 4 parts)	External angle (mitred pair) Corner radius 30 mm	Art. no. 95180
95180	95185	95181	95183	55187/55188	S95182	95186	Model number
244 x 225 x 150/105	119 x 225 x 150/105	244 x 225 x 150/105	119 x 225 x 150/105	dim. as channel	(2x) 344/119x225x150/105	(2x) 236 x 225 x 150/105	Nom. dim. - cm
4.000	8.000						Work size mm
7.000/piece	3.430/piece	6.600/piece	3.100/piece	0.200/piece	11.800/pair	8.300/pair	m - pieces
1 piece	2 pieces	1 piece	2 pieces		1 pair	1 pair	Pce./pair - kg
0.250	0.250						Bundle - pce./pair
7.000	6.860	6.600	6.200		11.800	8.300	Bundle - m
							Bundle - kg
							Pallet - m
							Pallet - kg
Alb	Alb	Alb	Alb	Alb	Alb	Alb	Product standard
700-95180	700-95185	700-95181	700-95183	700-55187/88	700-S95182	700-95186	neutral 10
Price gr. A625 (pce.)	Price gr. A560 (pce.)	Price gr. A663 (pce.)	Price gr. A615 (pce.)	Price gr. A487 (pce.)	Price gr. A734 (pair)	Price gr. A734 (pair)	(active white glossy)
701-95180	701-95185	701-95181	701-95183	701-55187/88	701-S95182	701-95186	neutral 10
Price gr. A625 (pce.)	Price gr. A560 (pce.)	Price gr. A663 (pce.)	Price gr. A615 (pce.)	Price gr. A487 (pce.)	Price gr. A734 (pair)	Price gr. A734 (pair)	(active white matt)
552001-95180	552001-95185	552001-95181	552001-95183	552001-55187/88	552001-S95182	552001-95186	active azure
Price gr. A629 (pce.)	Price gr. A573 (pce.)	Price gr. A668 (pce.)	Price gr. A618 (pce.)	Price gr. A489 (pce.)	Price gr. A742 (pair)	Price gr. A742 (pair)	
552002-95180	552002-95185	552002-95181	552002-95183	552002-55187/88	552002-S95182	552002-95186	light azure
Price gr. A629 (pce.)	Price gr. A573 (pce.)	Price gr. A668 (pce.)	Price gr. A618 (pce.)	Price gr. A489 (pce.)	Price gr. A742 (pair)	Price gr. A742 (pair)	neutral 1
5716-95180³	5716-95185³	5716-95181³	5716-95183³	5716-55187/88³	5716-S95182³	5716-95186³	(deep black)
Price gr. A629 (pce.)	Price gr. A573 (pce.)	Price gr. A668 (pce.)	Price gr. A618 (pce.)	Price gr. A489 (pce.)	Price gr. A742 (pair)	Price gr. A742 (pair)	

¹ For the matching outlet valve "Silent W 2000", refer to page 456
² Matching mosaic: see series Fresh
³ For reasons of production, differences in color between special pieces and standard tiles can occur.



Conic cuts for the products shown on this page are possible upon request.
 No pallet rebate is granted for the products shown on this page.
 All products: Color Shade Variation V0

The products shown on this page can also be produced in other colors of the series Chroma. We will be pleased to check the possibility of such a special production upon request.

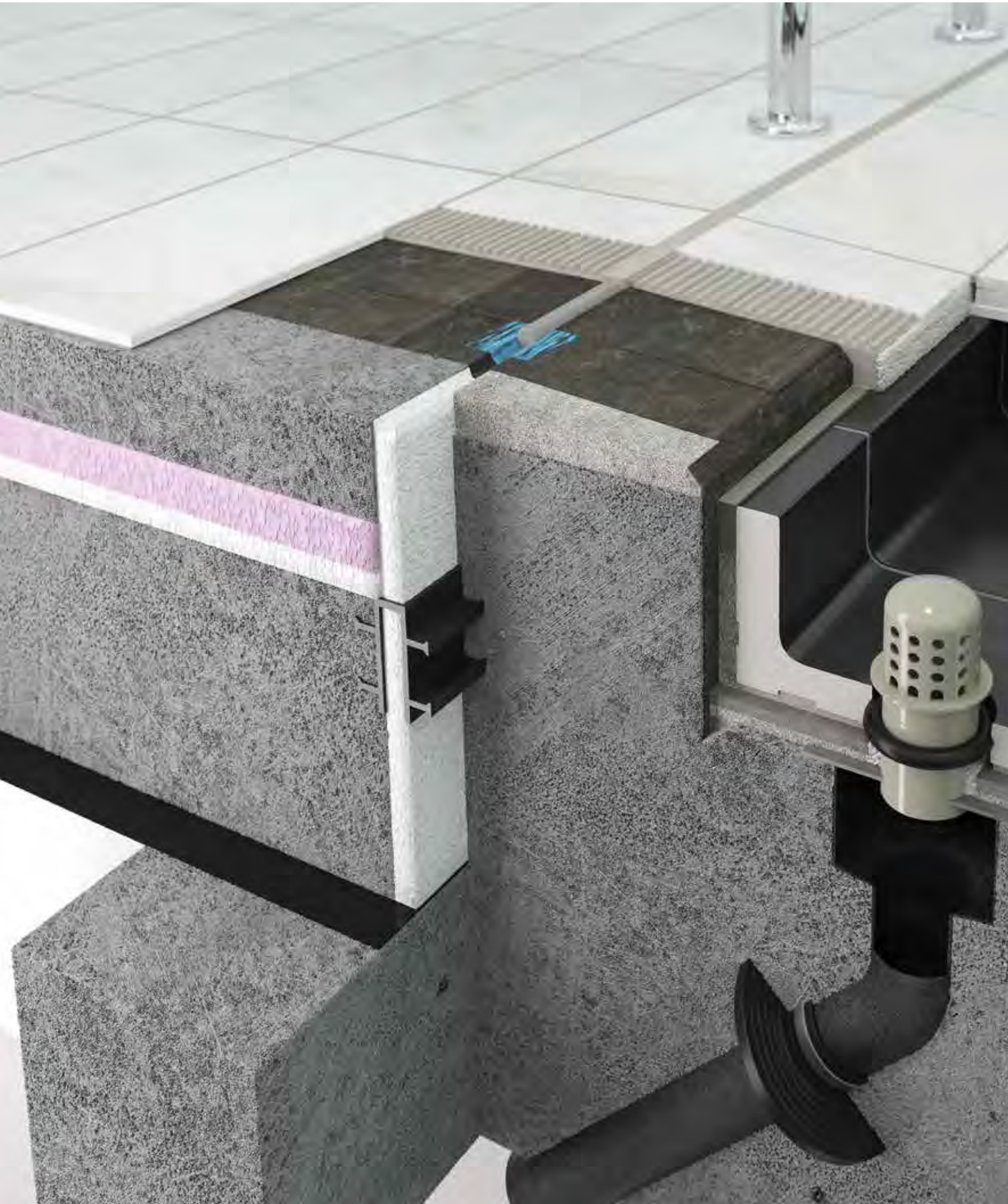



With a clear edge

The pool edge system Wiesbaden Stil is an elegant variation of the classic: the large overflow channel with handhold-piece is covered with a ceramic channel cover. Wiesbaden Stil is also available with mosaic recess on request. The ceramic channel cover enables a uniform design of the pool edge in the case of private and smaller hotel pools. The cover is easy to lay thanks to plug-in connections. The ceramic channel cover is slip-resistant, very robust and, on request and after a check, available in different formats and partly also for free shapes. Water flow rate: free cross-section of 245 cm²/m in case of standard hole pattern.

Wiesbaden Stil

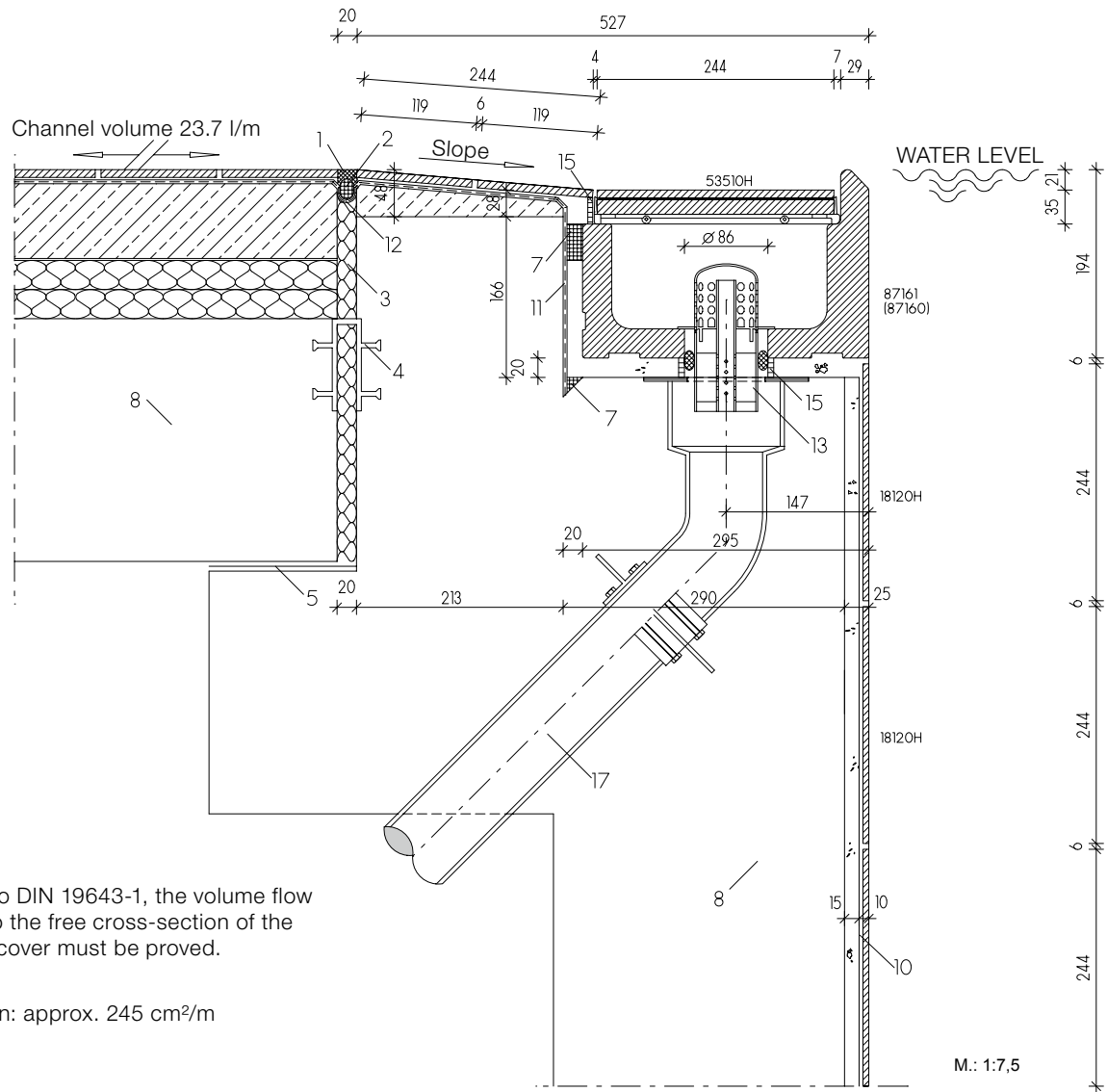

Note: according to DIN 19643-1, the volume flow rates in relation to the free cross-section of the ceramic channel cover must be proved.

Free cross-section: approx. 245 cm²/m

You will find the individual tiles and special pieces (= model numbers) of this system under:

- 18120H = Chroma tile (page 344 ff)
- 85160 = Overflow channel (page 391)
- 85161 = Overflow channel with outlet (page 391)
- 53510H = Ceramic channel cover (page 451)
- Outlet valve Silent W 2000 (page 456)

Legend:

- 01 UW-Silicone
- 02 Closed-cell polyethylene foam round lace
- 03 Elastic water-resistant filling material
- 04 Joint band
- 05 Slide bearing
- 06 Agrob Buchtal plastic cover grating

- 07 Capillary barrier/grouting (reaction resin filler)
- 08 Waterproof concrete (according to DIN EN 206/DIN 1045/DAfStB WU Guideline)
- 09 Conventional thick-bed laying
- 10 Thin-bed laying on cement render (P III, CS IV without added lime)
- 11 Sealing layer
- 12 Sealing tape
- 13 Outlet valve „Silent W 2000“ of Agrob Buchtal
- 14 Air inlet pipe for outlet „Silent 100“
- 15 Epoxi for joints (for the projekt sector)
- 16 Agrob Buchtal section stoneware pipe
- 17 Casing for water inlet/ outlet pipe and brazing collar

Large Channel (also available with mosaic recess = model 97160 upon request³)
(ceramic channel cover, width 250 mm)

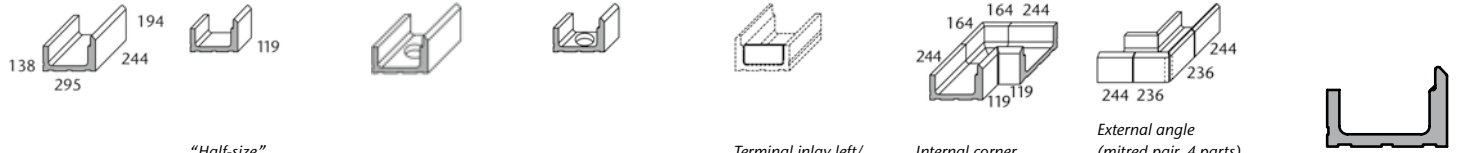

Overflow channel ¹	"Half-size" overflow channel	Outlet (Ø 86 mm) ²	Outlet (Ø 86 mm) ²	Terminal inlay left/terminal inlay right	Internal corner (mitred pair, 4 parts)	External angle (mitred pair, 4 parts) Corner radius 30 mm	Art. no. 87160
87160	87165	87161	87163	87167/87168	S87162	87166	Model number
244 x 295 x 138/194	119 x 295 x 138/194	244 x 295 x 138/194	119 x 295 x 138/194	dim. as channel	(2x) 414/119x295x138/194	(2x) 486 x 295 x 138/194	Nom. dim. - cm
4.000	8.000						Work size mm
10.200/piece	5.100/piece	10.000/piece	4.700/piece	0.300/piece	20.500/pair	30.000/pair	m - pieces
1 piece	2 pieces	1 piece	2 pieces		1 pair	1 pair	Pce./pair - kg
0.250	0.250						Bundle - pce./pair
10.200	10.200	10.000	9.400		20.500	30.000	Bundle - m
							Bundle - kg
							Pallet - m
							Pallet - kg
Alb	Alb	Alb	Alb	Alb	Alb	Alb	Product standard
700-87160	700-87165	700-87161	700-87163	700-87167/68	700-S87162	700-87166	neutral 10
Price gr. A649 (pce.)	Price gr. A581 (pce.)	Price gr. A668 (pce.)	Price gr. A625 (pce.)	Price gr. A484 (pce.)	Price gr. A792 (pair)	Price gr. A792 (pair)	(active white glossy)
701-87160	701-87165	701-87161	701-87163	701-87167/68	701-S87162	701-87166	neutral 10
Price gr. A649 (pce.)	Price gr. A581 (pce.)	Price gr. A668 (pce.)	Price gr. A625 (pce.)	Price gr. A484 (pce.)	Price gr. A792 (pair)	Price gr. A792 (pair)	(active white matt)
552001-87160	552001-87165	552001-87161	552001-87163	552001-87167/68	552001-S87162	552001-87166	active azure
Price gr. A654 (pce.)	Price gr. A587 (pce.)	Price gr. A683 (pce.)	Price gr. A629 (pce.)	Price gr. A489 (pce.)	Price gr. A800 (pair)	Price gr. A800 (pair)	
552002-87160	552002-87165	552002-87161	552002-87163	552002-87167/68	552002-S87162	552002-87166	light azure
Price gr. A654 (pce.)	Price gr. A587 (pce.)	Price gr. A683 (pce.)	Price gr. A629 (pce.)	Price gr. A489 (pce.)	Price gr. A800 (pair)	Price gr. A800 (pair)	
5716-87160⁴	5716-87165⁴	5716-87161⁴	5716-87163⁴	5716-87167/68⁴	5716-S87162⁴	5716-87166⁴	neutral 1
Price gr. A654 (pce.)	Price gr. A587 (pce.)	Price gr. A683 (pce.)	Price gr. A629 (pce.)	Price gr. A489 (pce.)	Price gr. A800 (pair)	Price gr. A800 (pair)	(deep black)

¹ Also available with rounded front edge for areas provided for ladders.
² For the matching outlet valve "Silent W 2000", refer to page 456
³ Matching mosaic: see series Plural S. 257 ff
⁴ For reasons of production, differences in color between special pieces and standard tiles can occur.

Conic cuts for the products shown on this page are possible upon request.
No pallet rebate is granted for the products shown on this page.

All products: Color Shade Variation V0

 The products shown on this page can also be produced in other colors of the series Chroma. We will be pleased to check the possibility of such a special production upon request.



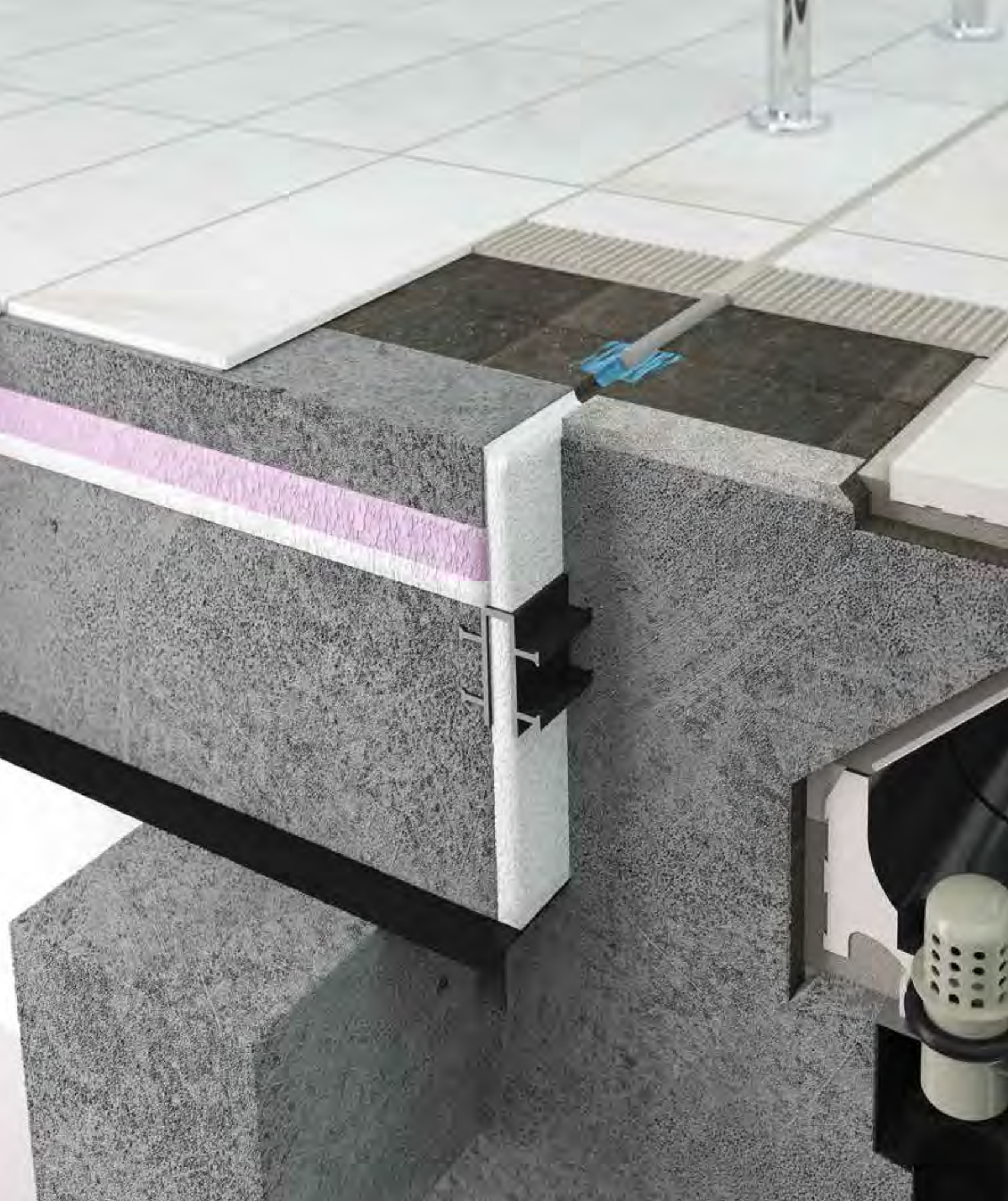



Specialist for attractions

The version with decreased water level permits an additional "accumulation height" which is desired above all for the use of water attractions. Thus, this system is optimally suitable for slide landing pools, for example.

Different channel cross-sections and dimensions extend the application possibilities, for example, in case of elevated pool walls in flow channels. Among other things, the outlet valve Silent W 2000 is available as an accessory.

Wiesbaden with decreased water level

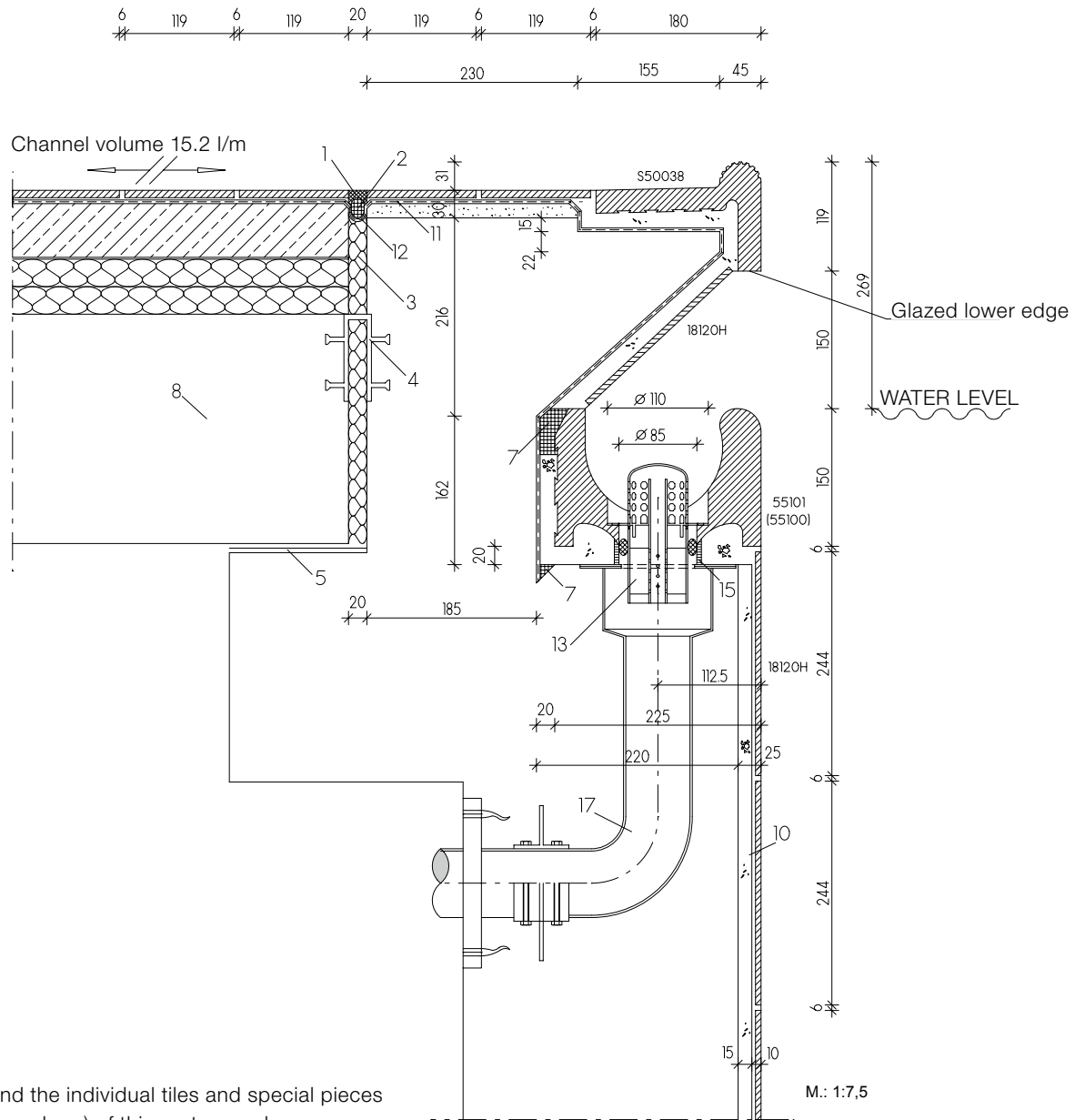

You will find the individual tiles and special pieces (= model numbers) of this system under:

- 18120H = Chroma tile (page 344 ff)
- 55100 = Overflow channel (page 395)
- 55101 = Overflow channel with outlet (page 395)
- S50038 = Pool edging tile (like 55450 with glazed lower edge, page 422)
- Outlet valve Silent W 2000 (page 456)

Legend:

- 01 UW-Silicone
- 02 Closed-cell polyethylene foam round lace
- 03 Elastic water-resistant filling material
- 04 Joint band
- 05 Slide bearing
- 06 Agrob Buchtal plastic cover grating

- 07 Capillary barrier/grouting (reaction resin filler)
- 08 Waterproof concrete (according to DIN EN 206/DIN 1045/DAfStB WU Guideline)
- 09 Conventional thick-bed laying
- 10 Thin-bed laying on cement render (P III, CS IV without added lime)
- 11 Sealing layer
- 12 Sealing tape
- 13 Outlet valve „Silent W 2000“ of Agrob Buchtal
- 14 Air inlet pipe for outlet „Silent 100“
- 15 Epoxi for joints (for the projekt sector)
- 16 Agrob Buchtal section stoneware pipe
- 17 Casing for water inlet/ outlet pipe and brazing collar

Large Channel (also available with mosaic recess = model 95100 upon request)
(without cover grating support)

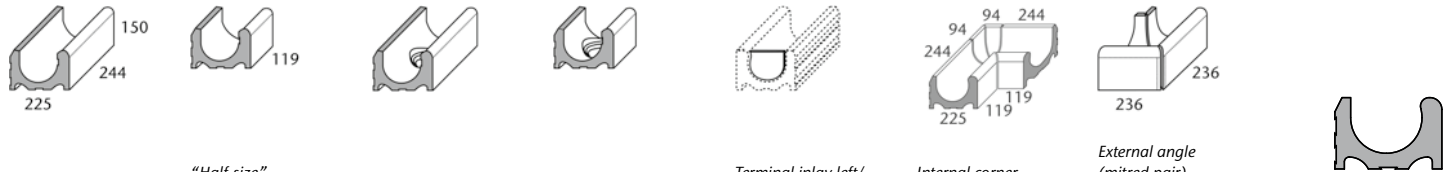

Overflow channel	"Half-size" overflow channel	Outlet (Ø 86 mm) ¹	Outlet (Ø 86 mm) ¹	Terminal inlay left/ terminal inlay right	Internal corner (mitred pair, 4 parts)	External angle (mitred pair) Corner radius 30 mm	Art. no. 55100
55100	55105	55101	S50065	55107/55108	S55102	55106	Model number
244 x 225 x 150	119 x 225 x 150	244 x 225 x 150	119 x 225 x 150	dim. as channel	(2x)344/119 x 225 x 150	(2x) 236 x 225 x 150	Nom. dim. - cm
4.000	8.000						Work size mm
8.600/piece	4.200/piece	8.100/piece	3.800/piece	0.200/piece	10.000/pair	9.600/pair	m - pieces
1 piece	2 pieces	1 piece	2 pieces		1 pair	1 pair	Pce./pair - kg
0.250	0.250						Bundle - pce./pair
8.600	8.400	8.100	7.600		16.000	9.600	Bundle - m
							Bundle - kg
							Pallet - m
							Pallet - kg
Alb	Alb	Alb	Alb	Alb	Alb	Alb	Product standard
700-55100	700-55105	700-55101	700-S50065	700-55107/08	700-S55102	700-55106	neutral 10
Price gr. A601 (pce.)	Price gr. A545 (pce.)	Price gr. A654 (pce.)	Price gr. A638 (pce.)	Price gr. A489 (pce.)	Price gr. A716 (pair)	Price gr. A716 (pair)	(active white glossy)
701-55100	701-55105	701-55101	701-S50065	701-55107/08	701-S55102	701-55106	neutral 10
Price gr. A601 (pce.)	Price gr. A545 (pce.)	Price gr. A654 (pce.)	Price gr. A638 (pce.)	Price gr. A489 (pce.)	Price gr. A716 (pair)	Price gr. A716 (pair)	(active white matt)
552001-55100	552001-55105	552001-55101	552001-S50065	552001-55107/08	552001-S55102	552001-55106	active azure
Price gr. A608 (pce.)	Price gr. A547 (pce.)	Price gr. A663 (pce.)	Price gr. A645 (pce.)	Price gr. A506 (pce.)	Price gr. A723 (pair)	Price gr. A723 (pair)	
552002-55100	552002-55105	552002-55101	552002-S50065	552002-55107/08	552002-S55102	552002-55106	light azure
Price gr. A608 (pce.)	Price gr. A547 (pce.)	Price gr. A663 (pce.)	Price gr. A645 (pce.)	Price gr. A506 (pce.)	Price gr. A723 (pair)	Price gr. A723 (pair)	
5716-55100²	5716-55105²	5716-55101²	5716-S50065²	5716-55107/08²	5716-S55102²	5716-55106²	neutral 1
Price gr. A608 (pce.)	Price gr. A547 (pce.)	Price gr. A663 (pce.)	Price gr. A645 (pce.)	Price gr. A506 (pce.)	Price gr. A723 (pair)	Price gr. A723 (pair)	(deep black)

¹ For the matching outlet valve "Silent W 2000", refer to page 456

² For reasons of production, differences in color between special pieces and standard tiles can occur.



Small Channel
(without cover grating support)

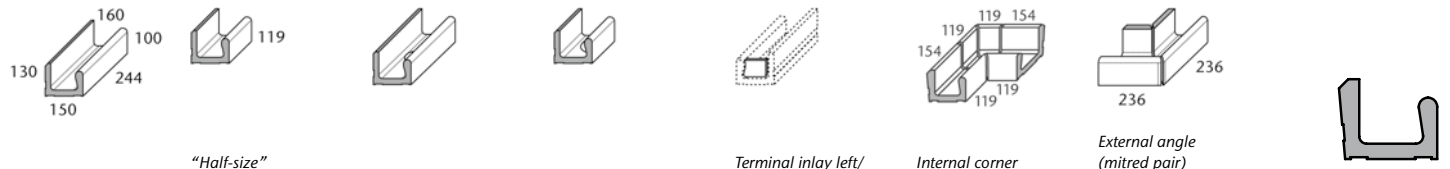

Overflow channel	"Half-size" overflow channel	Outlet (Ø 75 mm) ¹	Outlet (Ø 75 mm) ¹	Terminal inlay left/ terminal inlay right	Internal corner (mitred pair, 4 parts)	External angle (mitred pair) Corner radius 30 mm	Art. no. 55140
55140	55145	55141	55143	55147/55148	S55142	55146	Model number
244 x 150/160 x 100/130	119 x 150/160 x 100/130	244 x 150/160 x 100/130	119 x 150/160 x 100/130	dim. as channel	(2x)279/119x150/160x100/130	(2x) 236x150/160x100/130	Nom. dim. - cm
4.000	8.000						Work size mm
4.450/piece	2.260/piece	4.100/piece	2.000/piece	0.100/piece	7.050/pair	6.300/pair	m - pieces
2 pieces	4 pieces	2 pieces	4 pieces		1 pair	1 pair	Pce./pair - kg
0.500	0.500						Bundle - pce./pair
8.900	9.040	8.200	8.000		7.050	6.300	Bundle - m
							Bundle - kg
							Pallet - m
							Pallet - kg
Alb	Alb	Alb	Alb	Alb	Alb	Alb	Product standard
700-55140	700-55145	700-55141	700-55143	700-55147/48	700-S55142	700-55146	neutral 10
Price gr. A600 (pce.)	Price gr. A533 (pce.)	Price gr. A636 (pce.)	Price gr. A593 (pce.)	Price gr. A487 (pce.)	Price gr. A716 (pair)	Price gr. A716 (pair)	(active white glossy)
701-55140	701-55145	701-55141	701-55143	701-55147/48	701-S55142	701-55146	neutral 10
Price gr. A600 (pce.)	Price gr. A533 (pce.)	Price gr. A636 (pce.)	Price gr. A593 (pce.)	Price gr. A487 (pce.)	Price gr. A716 (pair)	Price gr. A716 (pair)	(active white matt)
552001-55140	552001-55145	552001-55141	552001-55143	552001-55147/48	552001-S55142	552001-55146	active azure
Price gr. A604 (pce.)	Price gr. A539 (pce.)	Price gr. A638 (pce.)	Price gr. A601 (pce.)	Price gr. A489 (pce.)	Price gr. A723 (pair)	Price gr. A723 (pair)	
552002-55140	552002-55145	552002-55141	552002-55143	552002-55147/48	552002-S55142	552002-55146	light azure
Price gr. A604 (pce.)	Price gr. A539 (pce.)	Price gr. A638 (pce.)	Price gr. A601 (pce.)	Price gr. A489 (pce.)	Price gr. A723 (pair)	Price gr. A723 (pair)	
5716-55140²	5716-55145²	5716-55141²	5716-55143²	5716-55147/48²	5716-S55142²	5716-55146²	neutral 1
Price gr. A604 (pce.)	Price gr. A539 (pce.)	Price gr. A638 (pce.)	Price gr. A601 (pce.)	Price gr. A489 (pce.)	Price gr. A723 (pair)	Price gr. A723 (pair)	(deep black)

¹ For the matching outlet valve "Silent W 2000", refer to page 456

² For reasons of production, differences in color between special pieces and standard tiles can occur.



Conic cuts for the products shown on this page are possible upon request.
No pallet rebate is granted for the products shown on this page.

All products: Color Shade Variation V0

The products shown on this page can also be produced in other colors of the series Chroma. We will be pleased to check the possibility of such a special production upon request.





In the version with small overflow channel without cover, Wiesbaden with decreased water level is primarily designed for the use in therapy facilities. In combination with an elevated pool edge, this results in a back-friendly effect for the staff, who can work with the patients without having to constantly adopt a stooped posture.

Project: Therapy pool DRK-Krankenhaus (hospital) / Location: Langen-Debstedt, Germany / Architect: Westphal u. Partner Architekten / Series: Pool edge system Wiesbaden / Photo: Veit S. Müller



Wiesbaden, therapy pools

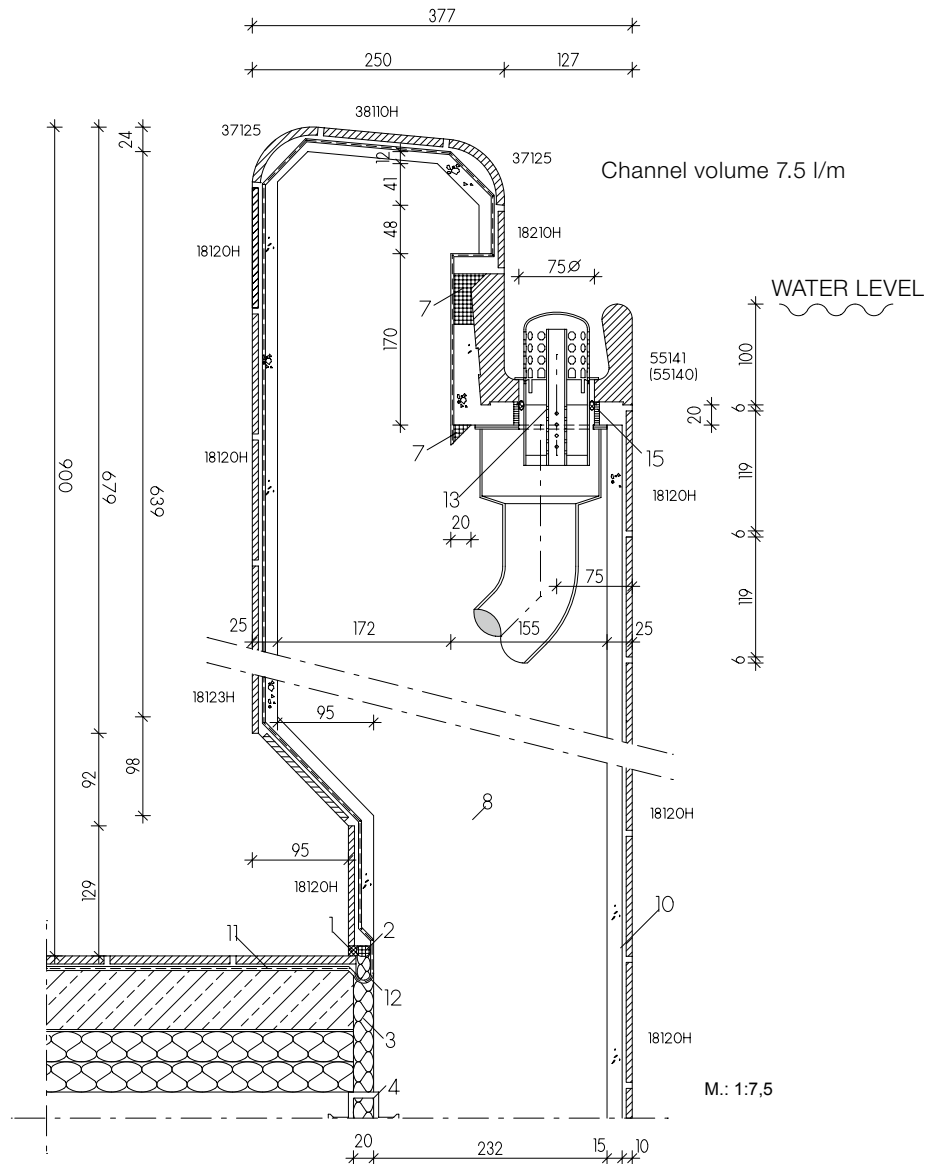

You will find the individual tiles and special pieces (= model numbers) of this system under:

18120H = Chroma tile (page 344 ff)
 55140 = Overflow channel (page 395)
 55141 = Overflow channel with outlet (page 395)
 18210H = Chroma strip tile (page 344 ff)
 37125 = Profiled edging (page 430)
 38110H = Chroma non-slip tile (page 349 ff)
 18123H = Chroma tile (page 347 ff)
 Outlet valve Silent W 2000 (page 456)

Legend:

01 UW-Silicone
 02 Closed-cell polyethylene foam round lace
 03 Elastic water-resistant filling material
 04 Joint band
 05 Slide bearing

06 Agrob Buchtal plastic cover grating
 07 Capillary barrier/grouting (reaction resin filler)
 08 Waterproof concrete (according to DIN EN 206/DIN 1045/DAfStB WU Guideline)
 09 Conventional thick-bed laying
 10 Thin-bed laying on cement render (P III, CS IV without added lime)
 11 Sealing layer
 12 Sealing tape
 13 Outlet valve „Silent W 2000“ of Agrob Buchtal
 14 Air inlet pipe for outlet „Silent 100“
 15 Epoxi for joints (for the projekt sector)
 16 Agrob Buchtal section stoneware pipe
 17 Casing for water inlet/ outlet pipe and brazing collar

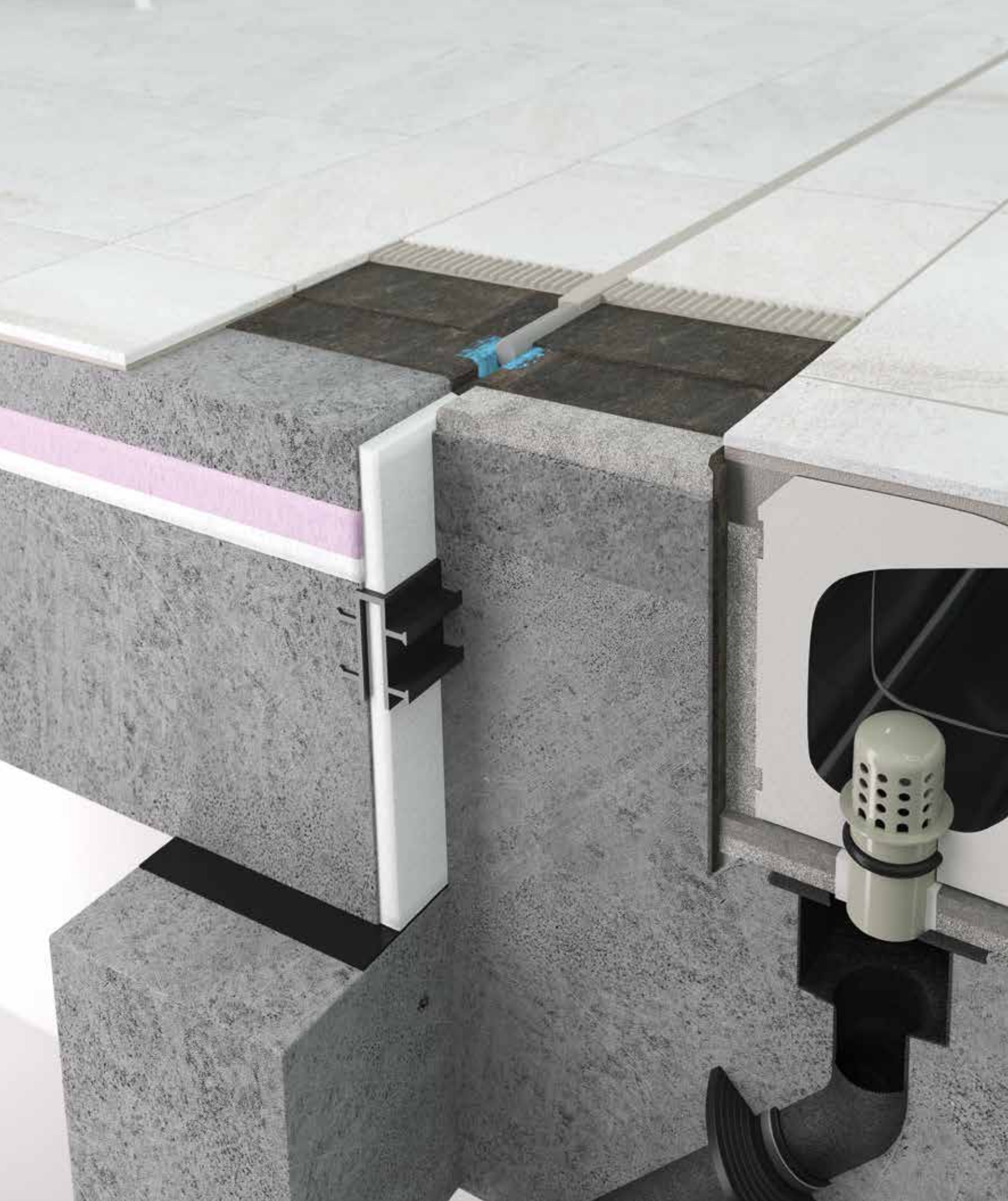



Sustainable innovation

Developed for Germany's first swimming pool satisfying the passive house requirements, the pool edge system Bamberg is convincing above all because of reduced water evaporation and a considerable decrease of the energy requirement. Additional advantages: elegant look without cover gratings and low noise level.

The versatile system shows its qualities in leisure and adventure pools just as well as in thermal, private and hotel pools. The large overflow channel with integrated handhold-piece makes cover gratings superfluous, directly adjoins the pool surround and thus creates a uniform overall picture. The profile of the overflow channel was developed in extensive, scientifically supervised tests.

Bamberg

While the splash water increases the evaporation rate in the case of conventional systems, the Bamberg Channel effects a considerable reduction thanks to its sophisticated design and thus makes an important contribution to energy saving: heat losses are reduced, the ventilation systems must circulate less air and thus consume less electricity. Bamberg offers additional possibilities for individual design by different colors for the handhold-piece and the channel, and special colors are also possible after a check.

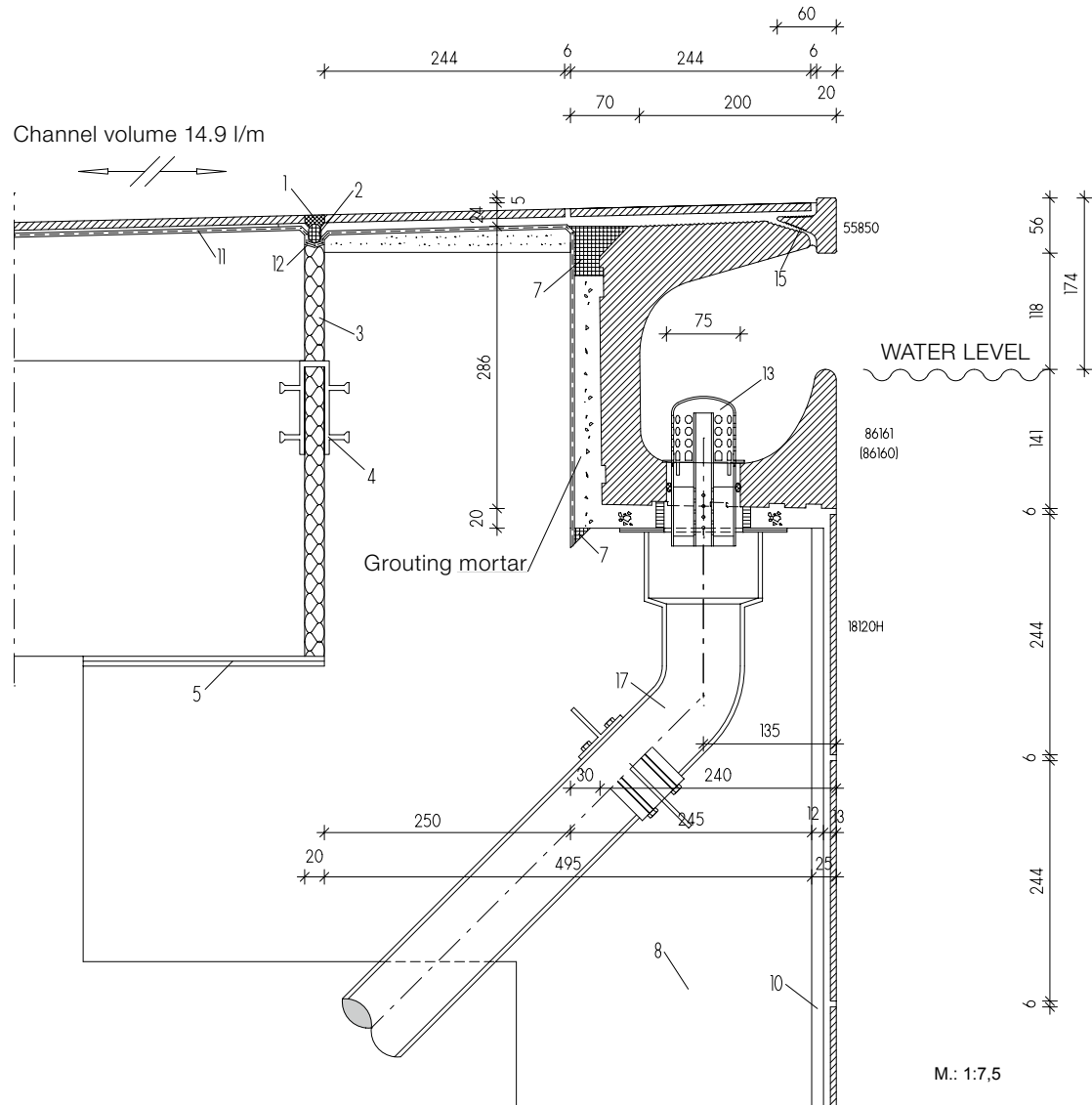

You will find the individual tiles and special pieces (= model numbers) of this system under:

18120H = Chroma tile (page 344 ff)
 86160 = Overflow channel (page 403)
 86161 = Overflow channel with outlet (Ø 75 mm) (page 403)
 55850 = Pool edging tile (page 403)
 55857/ = First piece left/right (page 403)
 55858
 Outlet valve Silent W 2000 (page 456)

Legend:

01 UW-Silicone
 02 Closed-cell polyethylene foam round lace
 03 Elastic water-resistant filling material
 04 Joint band
 05 Slide bearing

06 Agrob Buchtal plastic cover grating
 07 Capillary barrier/grouting (reaction resin filler)
 08 Waterproof concrete (according to DIN EN 206/DIN 1045/DAfStB WU Guideline)
 09 Conventional thick-bed laying
 10 Thin-bed laying on cement render (P III, CS IV without added lime)
 11 Sealing layer
 12 Sealing tape
 13 Outlet valve „Silent W 2000“ of Agrob Buchtal
 14 Air inlet pipe for outlet „Silent 100“
 15 Epoxi for joints (for the projekt sector)
 16 Agrob Buchtal section stoneware pipe
 17 Casing for water inlet/ outlet pipe and brazing collar

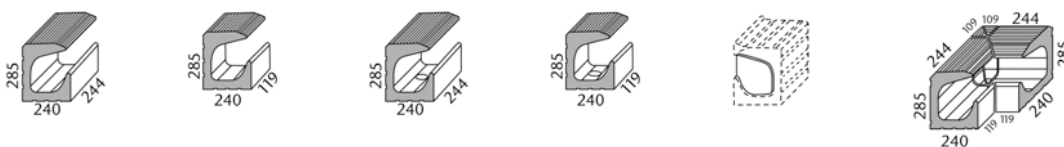

Overflow channel	"Half-size" overflow channel	Outlet (Ø 75 mm) ¹	Outlet (Ø 75 mm) ¹	Terminal inlay left/terminal inlay right	Internal corner (mitred pair, 4 parts)	Art. no. 86160
86160	86165	86161	86163	86167/86168	86162	Model number
244 x 240 x 285	119 x 240 x 285	244 x 240 x 285	119 x 240 x 285	dim. as channel	(2x) 359/119 x 240 x 285	Nom. dim. - cm
4,000	8,000					Work size mm
18.250/piece	8.900/piece	17.750/piece	8.600/piece	0.300/piece	45.000/pair	m - pieces
1 piece	2 pieces	1 piece	2 pieces		1 pair	Pce./pair - kg
0.250	0.250					Bundle - pce./pair
18.250	17.800	17.750	17.200		45.000	Bundle - m
						Bundle - kg
						Pallet - m
						Pallet - kg
Alb	Alb	Alb	Alb	Alb	Alb	Product standard
700-86160	700-86165	700-86161	700-86163	700-86167/68	700-86162	neutral 10
Price gr. A716 (pce.)	Price gr. A654 (pce.)	Price gr. A742 (pce.)	Price gr. A702 (pce.)	Price gr. A547 (pce.)	Price gr. A804 (pair)	(active white glossy)
701-86160	701-86165	701-86161	701-86163	701-86167/68	701-86162	neutral 10
Price gr. A716 (pce.)	Price gr. A654 (pce.)	Price gr. A742 (pce.)	Price gr. A702 (pce.)	Price gr. A547 (pce.)	Price gr. A804 (pair)	(active white matt)
552001-86160	552001-86165	552001-86161	552001-86163	552001-86167/68	552001-86162	
Price gr. A723 (pce.)	Price gr. A663 (pce.)	Price gr. A748 (pce.)	Price gr. A705 (pce.)	Price gr. A556 (pce.)	Price gr. A814 (pair)	active azure
552002-86160	552002-86165	552002-86161	552002-86163	552002-86167/68	552002-86162	
Price gr. A723 (pce.)	Price gr. A663 (pce.)	Price gr. A748 (pce.)	Price gr. A705 (pce.)	Price gr. A556 (pce.)	Price gr. A814 (pair)	light azure
5716-86160²	5716-86165²	5716-86161²	5716-86163²	5716-86167/68²	5716-86162²	neutral 1
Price gr. A723 (pce.)	Price gr. A663 (pce.)	Price gr. A748 (pce.)	Price gr. A705 (pce.)	Price gr. A556 (pce.)	Price gr. A814 (pair)	(deep black)

¹ For the matching outlet valve "Silent W 2000", refer to page 456

² For reasons of production, differences in color between special pieces and standard tiles can occur.

Please note: due to the shaping, external angles are not possible.



HANDHOLD-PIECE (T-PIECES)

Please note: use the XPS laying tool for the laying of the T-pieces



Accessory XPS laying tool	Pool edging tile	"Half-size" Pool edging tile	Internal corner (mitred pair)	External angle (mitred pair) Corner radius 30 mm	First piece left/right	Art. no. 55850
	55850	55855	55852	55856	55857/55858	Model number
	244 x 20/60 x 56	119 x 20/60 x 56	(2x) 119/175 x 20/60 x 56	(2x) 236/183 x 20/60 x 56	244 x 20/60 x 56	Nom. dim. - cm
	4.000	8.000				Work size mm
0.020/piece	0.900/piece	0.440/piece	0.440/pair	0.800/pair	0.910/piece	m - pieces
	18	36				Pce./pair - kg
	4.500	4.500				Bundle - pieces
	16.200	15.840				Bundle - m
						Bundle - kg
						Pallet - m
						Pallet - kg
	Alb	Alb	Alb	Alb	Alb	Product standard
F-190	700-55850	700-55855	700-55852	700-55856	700-55857/58	neutral 10
Price gr. A434 (pce.)	Price gr. A467 (pce.)	Price gr. A438 (pce.)	Price gr. A577 (pair)	Price gr. A587 (pair)	Price gr. A480 (pce.)	(active white glossy)
F-190	701-55850	701-55855	701-55852	701-55856	701-55857/58	neutral 10
Price gr. A434 (pce.)	Price gr. A467 (pce.)	Price gr. A438 (pce.)	Price gr. A577 (pair)	Price gr. A587 (pair)	Price gr. A480 (pce.)	(active white matt)
F-190	552001-55850	552001-55855	552001-55852	552001-55856	552001-55857/58	
Price gr. A434 (pce.)	Price gr. A471 (pce.)	Price gr. A441 (pce.)	Price gr. A581 (pair)	Price gr. A593 (pair)	Price gr. A484 (pce.)	active azure
F-190	552002-55850	552002-55855	552002-55852	552002-55856	552002-55857/58	
Price gr. A434 (pce.)	Price gr. A471 (pce.)	Price gr. A441 (pce.)	Price gr. A581 (pair)	Price gr. A593 (pair)	Price gr. A484 (pce.)	light azure
F-190	5716-55850²	5716-55855²	5716-55852²	5716-55856²	5716-55857/58²	neutral 1
Price gr. A434 (pce.)	Price gr. A471 (pce.)	Price gr. A441 (pce.)	Price gr. A581 (pair)	Price gr. A593 (pair)	Price gr. A484 (pce.)	(deep black)

² For reasons of production, differences in color between special pieces and standard tiles can occur.

Conic cuts for the products shown on this page are possible upon request.
No pallet rebate is granted for the products shown on this page.

All products: Color Shade Variation V0



The products shown on this page can also be produced in other colors of the series Chroma. We will be pleased to check the possibility of such a special production upon request.



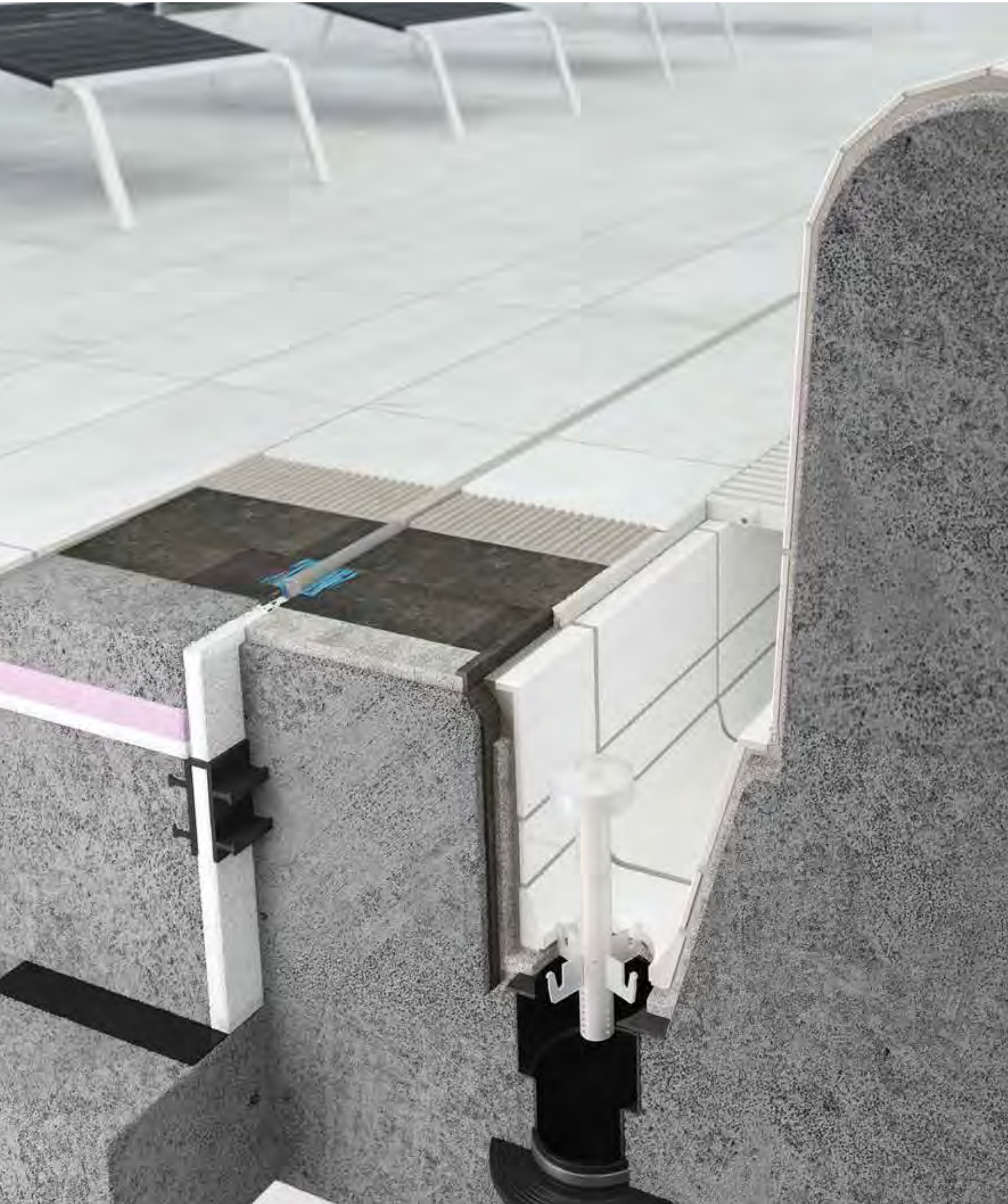



Bathing pleasure with panoramic view

The characteristic feature of the pool edge system St. Moritz is the elevated pool edge. This results in advantages not only with regard to pool construction. The bathers enjoy the view from their elevated position compared to the conventional construction method.

The system with integrated handhold-piece is tailored to the requirements of leisure and adventure pools, but also proves its worth in private and hotel pools. In the case of this construction, overflowing water flows down the outer walls of the pool into the channel on the outside, which is covered by a plastic grating. Cost advantages result above all from the lower foundation depth for the pool.

Project: Hotel aja / Location: Garmisch-Partenkirchen, Germany / Architect: SMAP SEEGER MÜLLER Berlin (Germany) and Korb office, Hamburg (Germany) / Series: Quarzit / Photo: Fotodesign Peters



St. Moritz

With the system St. Moritz, any pool edge widths with different edge covers can be realized. However, the "elevated" pool is also attractive for the bathers: they have an unobstructed view of the surroundings and can communicate with people outside the pool almost at eye level.

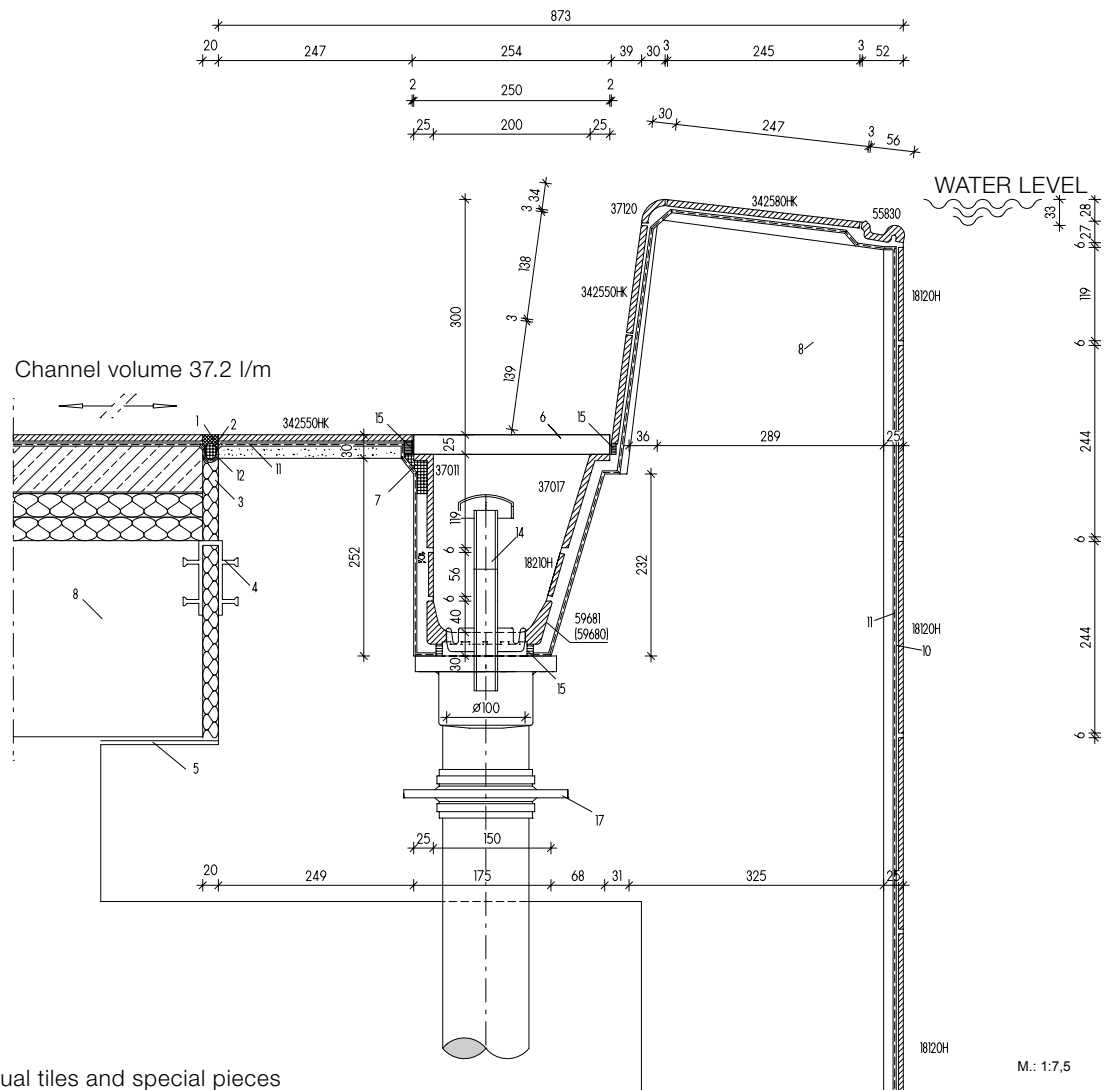

You will find the individual tiles and special pieces (= model numbers) of this system under:

- | | | |
|------------------------------------|--|--|
| 18120H | = Chroma tile (page 344 ff) | 05 Slide bearing |
| 55830 | = Handhold-piece (page 377) | 06 Agrob Buchtal plastic cover grating |
| 342580HK | = Quarzit grid profile tile (page 289) | 07 Capillary barrier/grouting (reaction resin filler) |
| 37120 | = Profiled edging (page 429) | 08 Waterproof concrete (according to
DIN EN 206/DIN 1045/DAfStB WU Guideline) |
| 342550HK | = Quarzit tile (page 289) | 09 Conventional thick-bed laying |
| 37017 | = Inclined shank-tile (page 443) | 10 Thin-bed laying on cement render
(P III, CS IV without added lime) |
| 18210H | = Chroma tile (page 344 ff) | 11 Sealing layer |
| 37011 | = Straight shank-tile (page 443) | 12 Sealing tape |
| 59681 (59680) | = Coved gutter tile (page 443) | 13 Outlet valve „Silent W 2000“
of Agrob Buchtal |
| Outlet valve Silent 100 (page 456) | | 14 Air inlet pipe for outlet „Silent 100“ |
| Cover grating (page 454) | | 15 Epoxi for joints (for the projekt sector) |
| | | 16 Agrob Buchtal section stoneware pipe |
| | | 17 Casing for water inlet/ outlet pipe and brazing collar |

Legend:

- 01 UW-Silicone
- 02 Closed-cell polyethylene foam round lace
- 03 Elastic water-resistant filling material
- 04 Joint band





Flexible alternative

In the case of this system, the elevated overflow edge is designed as a handhold. The covered channel, which collects the overflowing water, is located – viewed from the pool – directly behind it and ensures a smooth, low-noise water inflow thanks to its rounded shape.

Due to its design, the system Berlin is suitable for use in leisure and adventure pools, among others. With the overflow channel directly adjacent to the pool it can be considered as an alternative to the pool edge system Wiesbaden, but offers the advantage of greater flexibility: the width and depth of the channel are variable in the case of the pool edge system Berlin and can be exactly adapted to the local conditions.

410 SYSTEM BERLIN

Project: Indoor swimming pool / Location: Münster-Kinderhaus, Germany / Architect: Janßen Bär Partnerschaft / Series: Pool edge system Berlin, Chroma, Kauri, Unique, Valley / Photo: Stephan Brendgen



Berlin

Plastic channel covers are available as accessories. The outlet valve Silent 100 from Agrob Buchtal, which is also suitable for combination with the system Berlin, helps to effectively reduce the noise level in the pool.

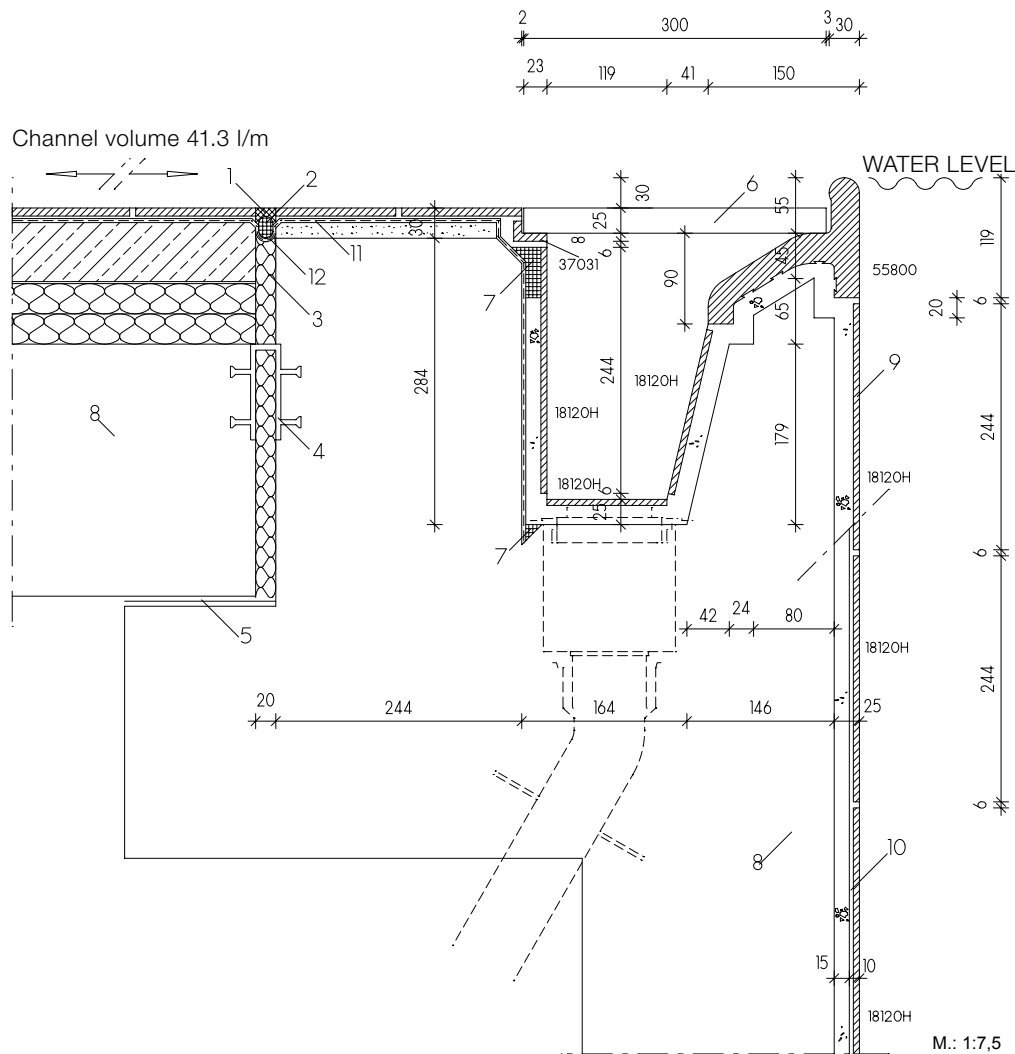

You will find the individual tiles and special pieces
(= model numbers) of this system under:

18120H = Chroma tile (page 344 ff)
55800 = Pool edging tile (page 423)
37031 = Supporting angle for grating (page 443)
Cover grating (page 454)

Legend:

01 UW-Silicone
02 Closed-cell polyethylene foam round lace
03 Elastic water-resistant filling material
04 Joint band
05 Slide bearing
06 Agrob Buchtal plastic cover grating

07 Capillary barrier/grouting (reaction resin filler)
08 Waterproof concrete (according to
DIN EN 206/DIN 1045/DAfStB WU Guideline)
09 Conventional thick-bed laying
10 Thin-bed laying on cement render
(P III, CS IV without added lime)
11 Sealing layer
12 Sealing tape
13 Outlet valve „Silent W 2000“
of Agrob Buchtal
14 Air inlet pipe for outlet „Silent 100“
15 Epoxi for joints (for the projekt sector)
16 Agrob Buchtal section stoneware pipe
17 Casing for water inlet/ outlet pipe and brazing collar





Designing with edging tiles

Like the pool edge system Berlin (presented on page 411), the Zürich system also has an elevated overflow edge, which serves as a handhold at the same time. However, the channel, which is covered with a plastic grating, is separated from the pool by edging tiles.

Thanks to the combination with pool edging tiles between the overflow edge and the drainage channel, the system is perfectly suitable for use in leisure and adventure pools. In addition, Zürich offers immense scope in terms of construction technique and aesthetic aspects. Thus, different channel volumes can be realized, depending on the requirements.

Project: Kombibad Gropiusstadt / Location: Berlin, Germany / Architect: Veauthier Meyer Architekten / Series: Pool edge system Zürich / Photo: Jochen Stüber



Zürich

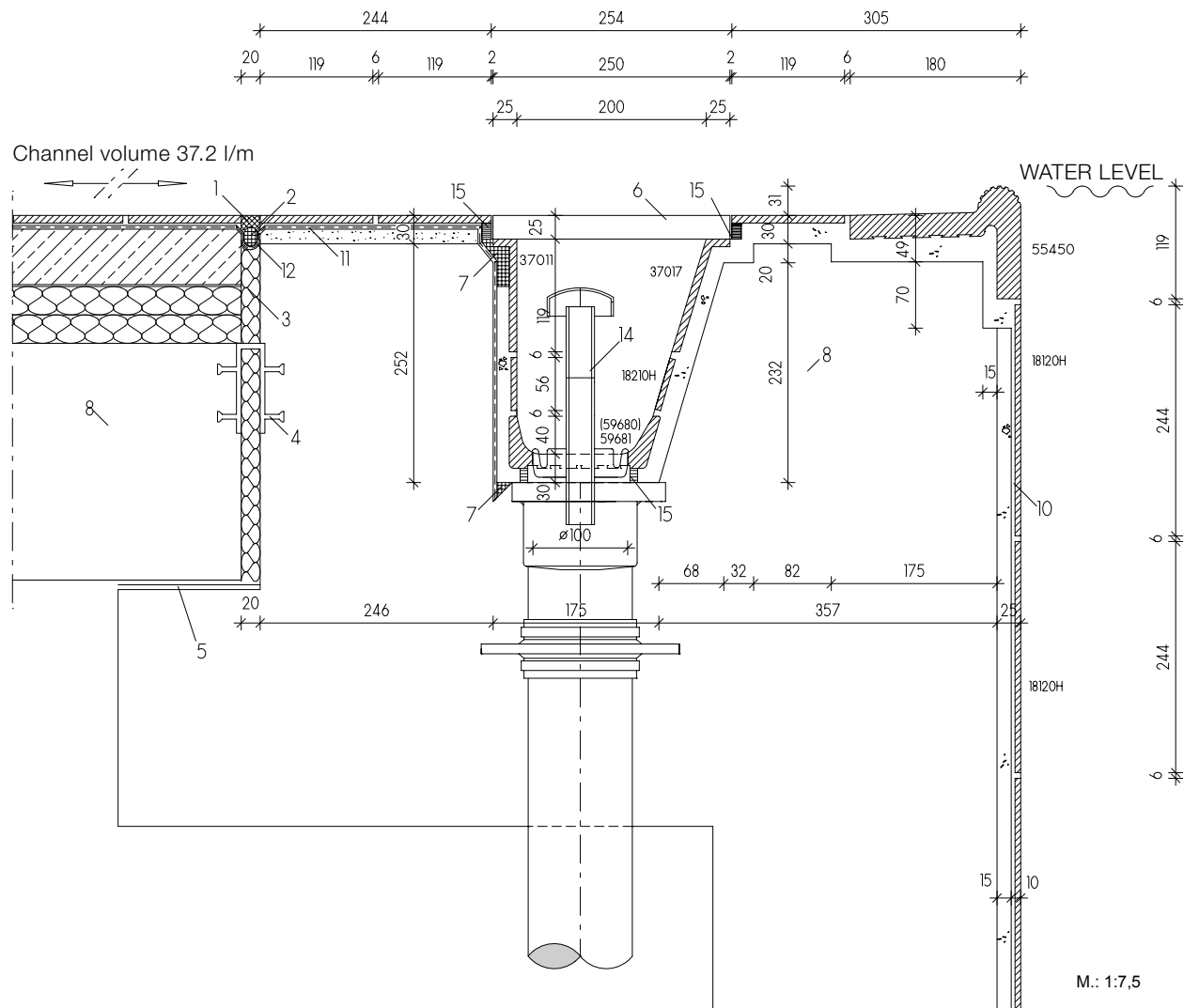

You will find the individual tiles and special pieces (= model numbers) of this system under:

- 18120H = Chroma tile (page 344 ff)
- 55450 = Pool edging tile (page 422)
- 37017 = Shank-tile (page 443)
- 18210H = Chroma tile (page 344 ff)
- 59681 = Coved gutter tile with outlet (page 443)
- 59680 = Coved gutter tile (page 443)
- 37011 = Shank-tile (page 443)
- Cover grating (page 454)
- Outlet valve Silent 100 (page 456)

Legend:

- 01 UW-Silicone
- 02 Closed-cell polyethylene foam round lace
- 03 Elastic water-resistant filling material
- 04 Joint band
- 05 Slide bearing
- 06 Agrob Buchtal plastic cover grating

- 07 Capillary barrier/grouting (reaction resin filler)
- 08 Waterproof concrete (according to DIN EN 206/DIN 1045/DAfStB WU Guideline)
- 09 Conventional thick-bed laying
- 10 Thin-bed laying on cement render (P III, CS IV without added lime)
- 11 Sealing layer
- 12 Sealing tape
- 13 Outlet valve „Silent W 2000“ of Agrob Buchtal
- 14 Air inlet pipe for outlet „Silent 100“
- 15 Epoxi for joints (for the projekt sector)
- 16 Agrob Buchtal section stoneware pipe
- 17 Casing for water inlet/ outlet pipe and brazing collar



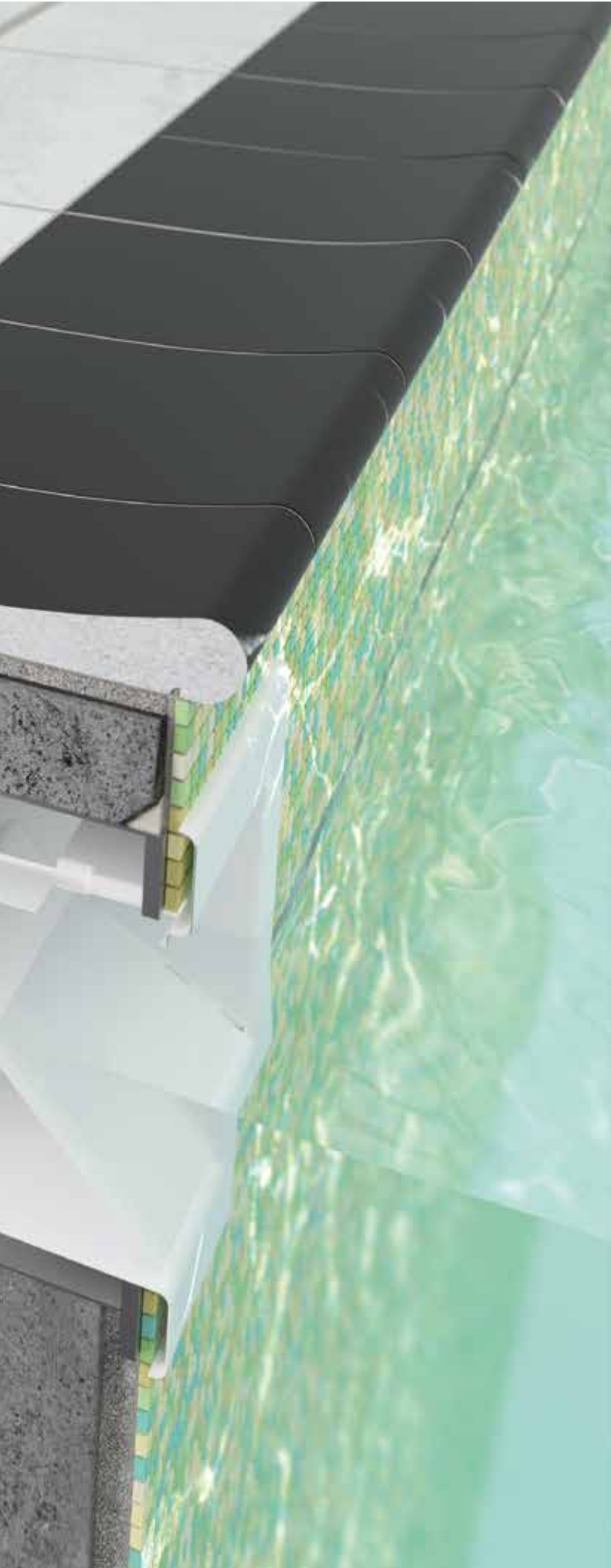

Low budget for private swimming pools

Wherever a low-cost solution for private pools is in demand, the Skimmer system is an ideal solution. For the water technology, only little effort is required. In terms of design, Skimmer offers individual freedom by different designs of the pool edge and the choice of suitable special pieces.

418 SYSTEM SKIMMER

Project: Villa in Southern Germany / Architect: own planning / Series: Natural Ceramics / Photo: Herbert Bürger



Skimmer

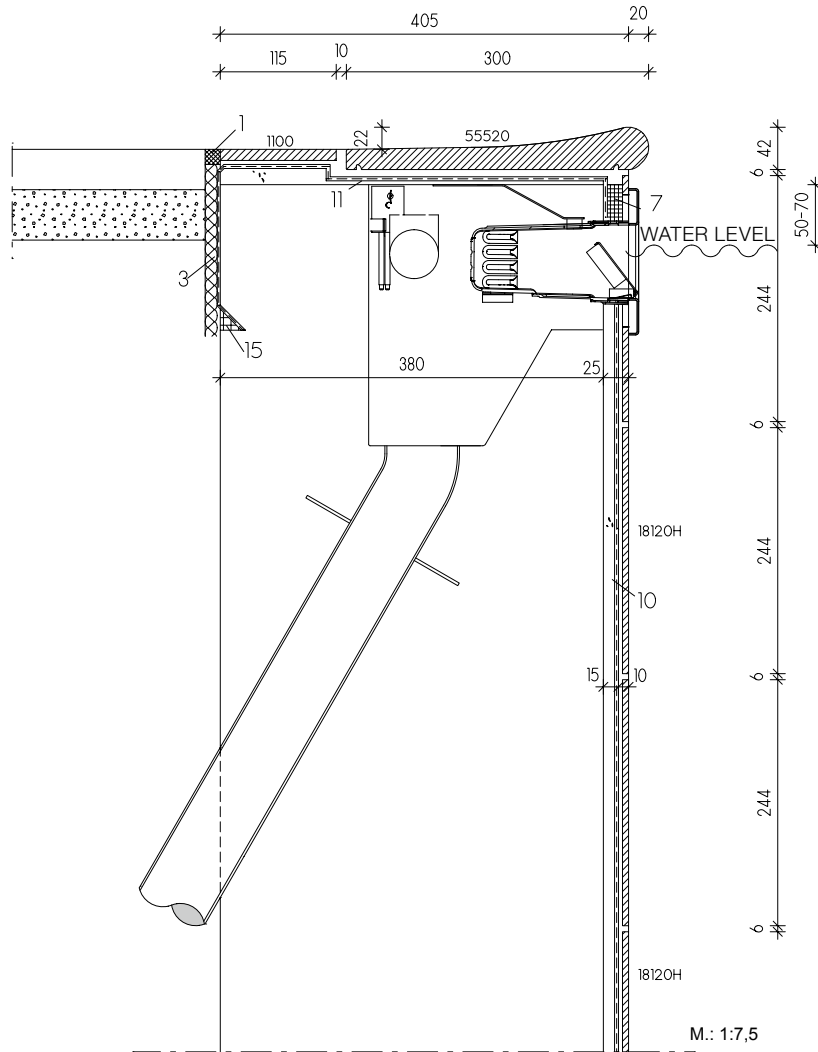

You will find the individual tiles and special pieces (= model numbers) of this system under:

18120H = Chroma tile (page 344 ff)
55520 = Pool edging tile Residence (page 423)

Legend:

01 UW-Silicone
02 Closed-cell polyethylene foam round lace
03 Elastic water-resistant filling material
04 Joint band
05 Slide bearing
06 Agrob Buchtal plastic cover grating
07 Capillary barrier/grouting (reaction resin filler)

08 Waterproof concrete (according to DIN EN 206/DIN 1045/DAfStB WU Guideline)
09 Conventional thick-bed laying
10 Thin-bed laying on cement render (P III, CS IV without added lime)
11 Sealing layer
12 Sealing tape
13 Outlet valve „Silent W 2000“ of Agrob Buchtal
14 Air inlet pipe for outlet „Silent 100“
15 Epoxi for joints (for the projekt sector)
16 Agrob Buchtal section stoneware pipe
17 Casing for water inlet/ outlet pipe and brazing collar

420 POOL EDGING TILES

Project: Terrassenbad (swimming pool) / Location: Baden, Switzerland / Architect: Bridevaux M. + Zimmermann M. Architekten AG, Baden / Series: Pool edging tiles, Plural unglazed / Photo: Adriano Faragulo

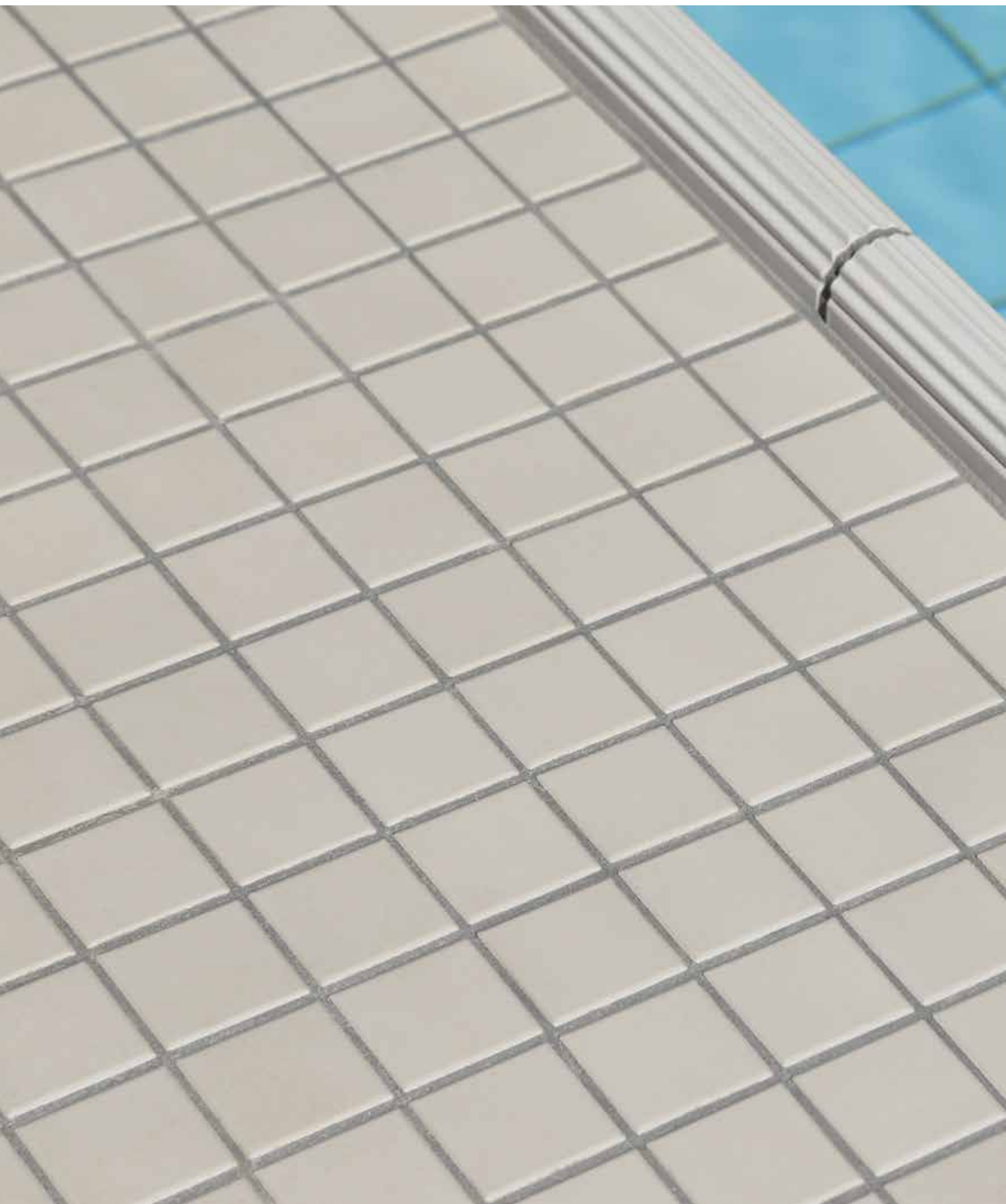



At the pool edge

Pool edging tiles can be found in all pool edge designs at which the edge is not already part of the pool edge system, such as the system Wiesbaden, for example. Or for bordering the pool in places where no drainage channel is provided. They have several functions: in addition to a colored marking of the pool edge both inside and outside the pool, pool edging tiles offer above all a safe hold for the swimmer and therefore are an important safety feature. For different designs of the pool edge, several variants are available, some of which can be used across different types of design.

e.g. for the Systems Zürich, Wiesbaden with decreased water level, "Skimmer" etc.



Art. no. 55440

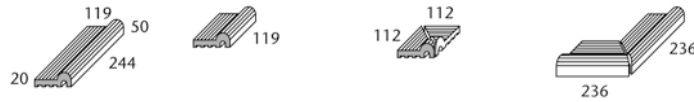

	Pool edging tile	"Half-size" Pool edging tile	Internal corner (mitred pair)	External angle (mitred pair) Corner radius 30 mm
Model number	55440	55445	55442	55446
Nom. dim. - cm				
Work size mm	244 x 119/50 x 20	119 x 119/50 x 20	(2x) 112 x 112/50 x 20	(2x) 236 x 119/50 x 20
m - pieces	4.000	8.000		
Pce./pair - kg	1.550/piece	0.780/piece	0.600/pair	2.500/pair
Bundle - pce./pair	10 pieces	20 pieces	2 pairs	5 pairs
Bundle - m	2.500	2.500		
Bundle - kg	15.500	15.600	1.200	12.500
Pallet - m				
Pallet - kg				
Product standard	Alb	Alb	Alb	Alb
Slip resistance	-/C	-/C	-/C	-/C
grey-beige	900-55440 Price gr. A511 (pce.)	900-55445 Price gr. A467 (pce.)	900-55442 Price gr. A533 (pair)	900-55446 Price gr. A608 (pair)
900 grey-beige	700-55440 Price gr. A528 (pce.)	700-55445 Price gr. A475 (pce.)	700-55442 Price gr. A545 (pair)	700-55446 Price gr. A625 (pair)
700 n10/white gl.	900-55440 Price gr. A528 (pce.)	701-55445 Price gr. A475 (pce.)	701-55442 Price gr. A545 (pair)	701-55446 Price gr. A625 (pair)
900 grey-beige	701-55440 Price gr. A528 (pce.)	552001-55440 Price gr. A545 (pce.)	552001-55442 Price gr. A560 (pair)	552001-55446 Price gr. A645 (pair)
701 n10/white matt	552001-55440 Price gr. A545 (pce.)	552002-55440 Price gr. A545 (pce.)	552002-55442 Price gr. A560 (pair)	552002-55446 Price gr. A645 (pair)
900 grey-beige	552001-55440 Price gr. A545 (pce.)	552002-55440 Price gr. A545 (pce.)	552002-55442 Price gr. A560 (pair)	552002-55446 Price gr. A645 (pair)
552001 active azure	552002-55440 Price gr. A545 (pce.)	5716-55440² Price gr. A545 (pce.)	5716-55442² Price gr. A560 (pair)	5716-55446² Price gr. A645 (pair)
900 grey-beige	5716-55440² Price gr. A545 (pce.)			
552002 light azure				
900 grey-beige				
5716 n1/black				



In the case of these special pieces, the overhang and the grooves are glazed in the respective colors.

² For reasons of production, differences in color between special pieces and standard tiles can occur.

e.g. for the Systems Zürich, Wiesbaden with decreased water level, "Skimmer" etc.



Art. no. 55450



	Pool edging tile lower edge unglazed	"Half-size" Pool edging tile	Internal corner (mitred pair)	External angle (mitred pair) Corner radius 30 mm
Model number	55450	55455	55452	55456
Nom. dim. - cm				
Work size mm	244 x 180/119 x 28	119 x 180/119 x 28	(2x) 173 x 173 x 28	(2x) 236 x 180/119 x 28
m - pieces	4.000	8.000		
Pce./pair - kg	3.700/piece	1.800/piece	1.800/pair	5.500/pair
Bundle - pce./pair	4 pieces	8 pieces	2 pairs	1 pair
Bundle - m	1.000	1.000		
Bundle - kg	14.800	14.400	3.600	5.500
Pallet - m				
Pallet - kg				
Product standard	Alb	Alb	Alb	Alb
Slip resistance	-/C	-/C	-/C	-/C
81 n10/white	900039-55450 Price gr. A625 (pce.)	900039-55455 Price gr. A560 (pce.)	900039-55452 Price gr. A663 (pair)	900039-55456 Price gr. A748 (pair)
700 n10/white gl.	900464-55450 Price gr. A625 (pce.)	900464-55455 Price gr. A560 (pce.)	900464-55452 Price gr. A663 (pair)	900464-55456 Price gr. A748 (pair)
81 n10/white	900566-55450 Price gr. A645 (pce.)	900566-55455 Price gr. A573 (pce.)	900566-55452 Price gr. A683 (pair)	900566-55456 Price gr. A766 (pair)
701 n10/white matt	900674-55450 Price gr. A645 (pce.)	900674-55455 Price gr. A573 (pce.)	900674-55452 Price gr. A683 (pair)	900674-55456 Price gr. A766 (pair)
81 n10/white	900615-55450² Price gr. A645 (pce.)	900615-55455² Price gr. A573 (pce.)	900615-55452² Price gr. A683 (pair)	900615-55456² Price gr. A766 (pair)
552001 active azure				
81 n10/white				
552002 light azure				
81 n10/white				
5716 n1/black				

In the case of these special pieces, the overhang and the grooves are glazed in the respective colors, the tread surface is white (81).

¹ For cover gratings, refer to page 454, coved gutter tiles refer to page 443

² For reasons of production, differences in color between special pieces and standard tiles can occur. No pallet rebate is granted for the products shown on this page.

All products: Color Shade Variation V0

The products shown on this page can also be produced in other colors of the series Chroma and Chroma non-slip. We will be pleased to check the possibility of such a special production upon request.

e.g. for the Systems Zürich, Wiesbaden with decreased water level, "Skimmer" etc.

25 x 30 cm

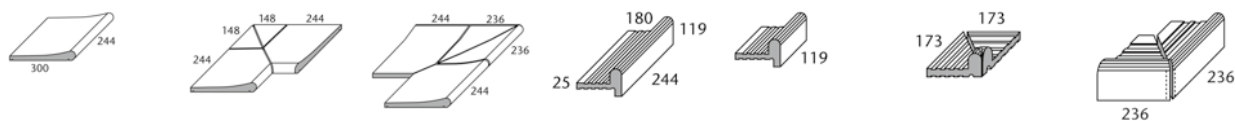

Residence ²	Internal corner 4 parts	External corner 4 parts	Pool edging tile	"Half-size" Pool edging tile	Internal corner (mitred pair)	External angle (mitred pair) Corner radius 30 mm	
55520	55522	55526	55460	55465	55462	55466	Model number
25 x 30 / 10 x 12							Nom. dim. - cm/in
244 x 300 x 20/42	(2x) 398/102 x 300 x 20/42	(2x) 490 x 300 x 20/42	244 x 180/119 x 25	119 x 180/119 x 25	(2x) 173 x 173 x 25	(2x) 236 x 180/119 x 25	Work size mm
4.000			4.000	8.000			m - pieces
4.300/piece	11.900/piece	11.900/piece	3.720/piece	1.800/piece	1.500/pair	5.700/pair	Pce./pair - kg
4 pieces	1 piece	1 piece	4 pieces	8 pieces	4 pairs	1 pair	Bundle - pce./pair
1.000			1.000	1.000			Bundle - m
17.200	11.900	11.900	14.880	14.400	6.000	5.700	Bundle - kg
							Pallet - m
							Pallet - kg
Alb	Alb	Alb	Alb	Alb	Alb	Alb	Product standard
-/B	-/B	-/B					Slip resistance
			700-55460	700-55465	700-55462	700-55466	neutral 10
			Price gr. A625 (pce.)	Price gr. A560 (pce.)	Price gr. A654 (pair)	Price gr. A734 (pair)	(active white glossy)
			701-55460	701-55465	701-55462	701-55466	neutral 10
			Price gr. A625 (pce.)	Price gr. A560 (pce.)	Price gr. A654 (pair)	Price gr. A734 (pair)	(active white matt)
			552001-55460	552001-55465	552001-55462	552001-55466	active azure
			Price gr. A645 (pce.)	Price gr. A573 (pce.)	Price gr. A683 (pair)	Price gr. A748 (pair)	
			552002-55460	552002-55465	552002-55462	552002-55466	light azure
			Price gr. A645 (pce.)	Price gr. A573 (pce.)	Price gr. A683 (pair)	Price gr. A748 (pair)	neutral 1
			5716-55460 ³	5716-55465 ³	5716-55462 ³	5716-55466 ³	neutral 10
			Price gr. A645 (pce.)	Price gr. A573 (pce.)	Price gr. A683 (pair)	Price gr. A748 (pair)	(active white)
91-55520	91-55522	91-55526					active azure
Price gr. A514 (pce.)	Price gr. A668 (pair)	Price gr. A741 (pair)					
553001-55520	553001-55522	553001-55526					
Price gr. A528 (pce.)	Price gr. A683 (pair)	Price gr. A757 (pair)					

² For this article, conic cuts are possible upon request.

³ For reasons of production, differences in color between special pieces and standard tiles can occur.

In the case of these special pieces, the overhang and the grooves are glazed in the respective colors.



for System Berlin



			Pool edging tile	"Half-size" Pool edging tile	Internal corner (mitred pair)	External angle (mitred pair) Corner radius 30 mm	
			55800	55805	55802	55806	Art. no. 55800
							Model number
			244 x 150/119 x 25/30	119 x 150/119 x 25/30	(2x) 143 x 143/119	(2x) 236 x 150/119 x 25/30	Nom. dim. - cm/in
			4.000	8.000			Work size mm
			3.700/piece	1.800/piece	1.600/pair	5.400/pair	m - pieces
			3 pieces	6 pieces	1 pair	1 pair	Pce./pair - kg
			0.750	0.750			Bundle - pce./pair
			11.100	10.800	1.600	5.400	Bundle - m
							Bundle - kg
							Pallet - m
							Pallet - kg
			Alb	Alb	Alb	Alb	Product standard
			700-55800	700-55805	700-55802	700-55806	neutral 10
			Price gr. A638 (pce.)	Price gr. A577 (pce.)	Price gr. A668 (pair)	Price gr. A754 (pair)	(active white glossy)
			701-55800	701-55805	701-55802	701-55806	neutral 10
			Price gr. A638 (pce.)	Price gr. A577 (pce.)	Price gr. A668 (pair)	Price gr. A754 (pair)	(active white matt)
			552001-55800	552001-55805	552001-55802	552001-55806	active azure
			Price gr. A654 (pce.)	Price gr. A587 (pce.)	Price gr. A683 (pair)	Price gr. A766 (pair)	
			552002-55800	552002-55805	552002-55802	552002-55806	light azure
			Price gr. A654 (pce.)	Price gr. A587 (pce.)	Price gr. A683 (pair)	Price gr. A766 (pair)	neutral 1
			5716-55800 ³	5716-55805 ³	5716-55802 ³	5716-55806 ³	(deep black)
			Price gr. A654 (pce.)	Price gr. A587 (pce.)	Price gr. A683 (pair)	Price gr. A766 (pair)	



The products shown on this page can also be produced in other colors of the series Chroma and Chroma non-slip. We will be pleased to check the possibility of such a special production upon request.

¹ For cover gratings, refer to page 454, coved gutter tiles refer to page 443

³ For reasons of production, differences in color between special pieces and standard tiles can occur.

No pallet rebate is granted for the products shown on this page.

All products: Color Shade Variation V0



Project: School swimming pool Grossacher / Location: Winkel, Switzerland / Architect: Energie- und Haustechnik Weber AG, Watt / Series: Chroma / Photo: Adriano Faragulo





Variety of practical special pieces

No matter how complex a pool design may be – a large number of well thought-out and solid ceramic special pieces guarantee a problem-free realization. From the different systems, the appropriate pool end pieces can be combined according to the principle of a modular system. Special forms such as rounded edges by means of profiled edgings, skirtings or cove skirtings in diverse designs ensure a minimum of risk of injury, extremely easy cleaning and care as well as maximum robustness.

- Skirtings
- Profiled edgings

Skirtings combined with profiled edgings

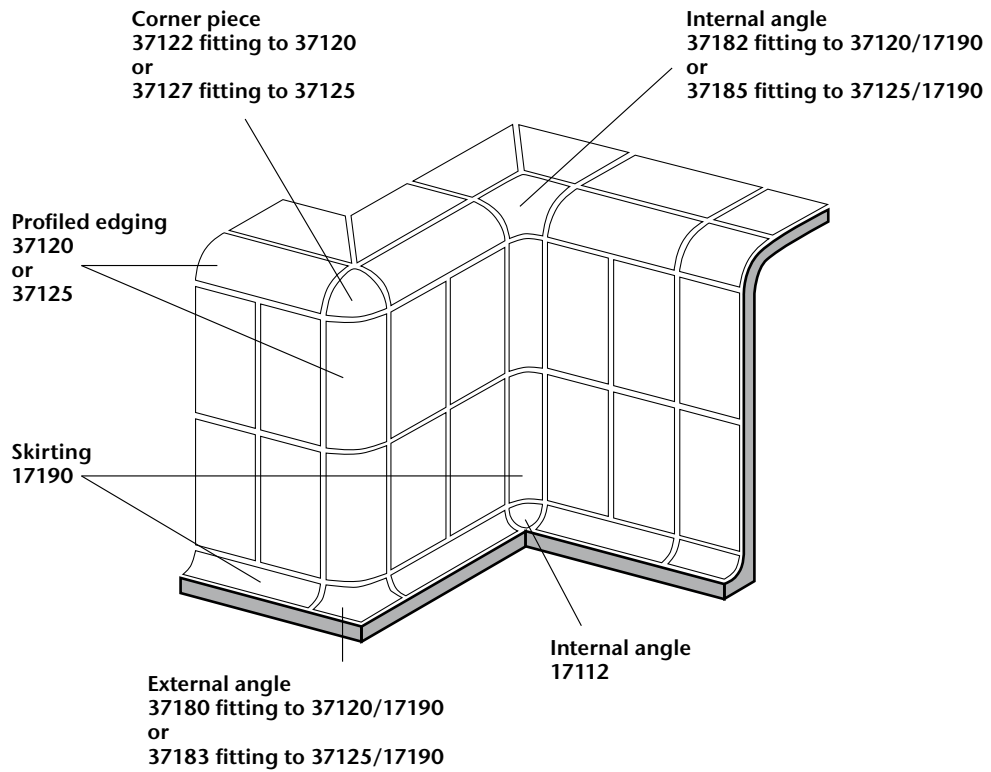

Cove Skirting combined with profiled edgings

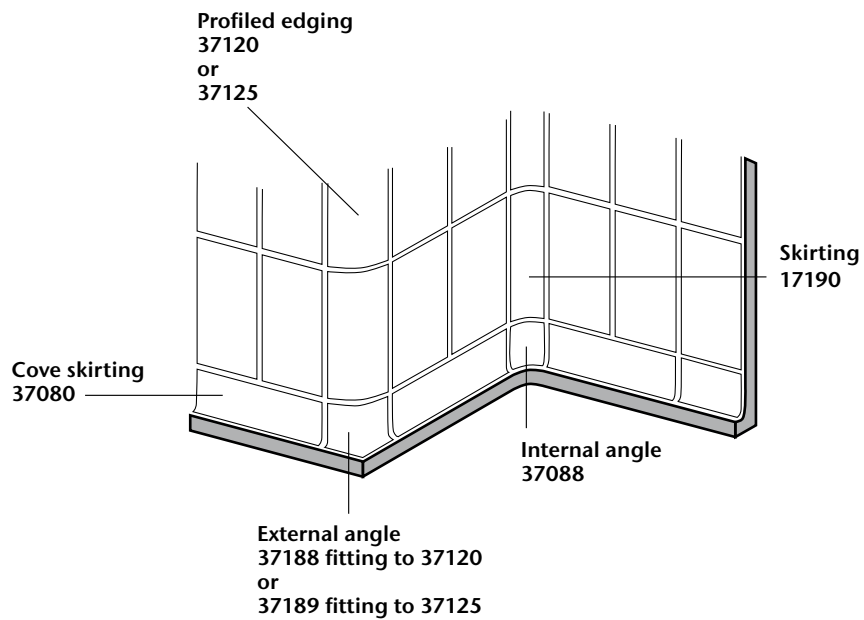

Radius 33 mm¹

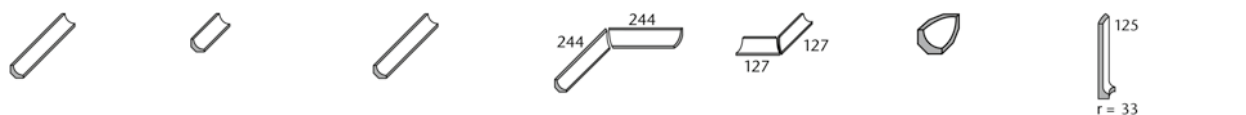

Skirting, r = 33 mm	Skirting "half-size"	End-skirting	Internal angle mitred pair	External angle mitred pair	Internal angle for skirtings for connection on 3 sides	Internal angle for the connection of cove skirting 37080 and skirting 17190		
17190	17193	17191	17196	17194	17112	37088		Model number
244 x r33 x 6	119 x r33 x 6	244 x r33 x 6	244/244 x r33 x 6	127/127 x r33 x 6	33 x 33 x 33	125 x r33 x 8		Nom. dim.
4.000	8.000							Work size mm
0.300/piece	0.140/piece	0.300/piece	0.550/pair	0.350/pair	0.090/piece	0.300/piece		m - pieces
54 pieces	108 pieces	54 pieces	27 pairs	24 pairs				Pce./pair - kg
13.500	13.500							Bundle - pce./pair
16.200	15.120	16.200	14.850	8.400				Bundle - m
								Bundle - kg
								Pallet - m
								Pallet - kg
Alb	Alb	Alb	Alb	Alb	Alb	Alb		Product standard
700-17190	700-17193	700-17191	700-17196	700-17194	700-17112	700-37088	4	neutral 10
Price gr. A423 (pce.)	Price gr. A413 (pce.)	Price gr. A425 (pce.)	Price gr. A471 (pair)	Price gr. A471 (pair)	Price gr. A434 (pce.)	Price gr. A480 (pce.)		(active white glossy)
701-17190	701-17193	701-17191	701-17196	701-17194	701-17112	701-37088	4	neutral 10
Price gr. A423 (pce.)	Price gr. A413 (pce.)	Price gr. A425 (pce.)	Price gr. A471 (pair)	Price gr. A471 (pair)	Price gr. A434 (pce.)	Price gr. A480 (pce.)		(active white matt)
552001-17190	552001-17193	552001-17191	552001-17196	552001-17194	552001-17112	552001-37088	2	active azure
Price gr. A425 (pce.)	Price gr. A416 (pce.)	Price gr. A428 (pce.)	Price gr. A475 (pair)	Price gr. A475 (pair)	Price gr. A438 (pce.)	Price gr. A484 (pce.)		
552002-17190	552002-17193	552002-17191	552002-17196	552002-17194	552002-17112	552002-37088	4	light azure
Price gr. A425 (pce.)	Price gr. A416 (pce.)	Price gr. A428 (pce.)	Price gr. A475 (pair)	Price gr. A475 (pair)	Price gr. A438 (pce.)	Price gr. A484 (pce.)		
5716-17190³	5716-17193³	5716-17191³	5716-17196³	5716-17194³	5716-17112³	5716-37088³	1	neutral 1
Price gr. A425 (pce.)	Price gr. A416 (pce.)	Price gr. A428 (pce.)	Price gr. A475 (pair)	Price gr. A475 (pair)	Price gr. A438 (pce.)	Price gr. A484 (pce.)		(deep black)
900-17190²	900-17193²	900-17191²	900-17196²	900-17194²	900-17112²	900-37088²		grey-beige
Price gr. A428 (pce.)	Price gr. A416 (pce.)	Price gr. A434 (pce.)	Price gr. A487 (pair)	Price gr. A487 (pair)	Price gr. A442 (pce.)	Price gr. A480 (pce.)		

¹ System also available in a length of 294 mm on request.



Radius 60 mm

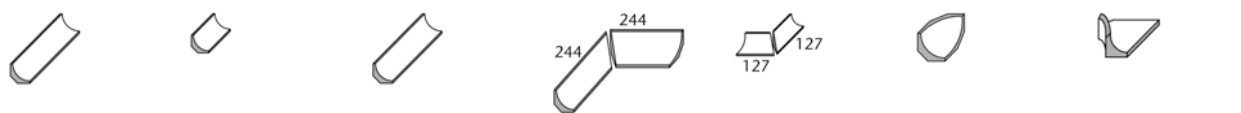

Skirting, r = 60 mm	Skirting "half-size"	End-skirting	Internal angle mitred pair	External angle mitred pair	Internal angle for skirtings for connection on 3 sides	External angle for the connection of skirting 18190 and radial skirting 37125		
18190	18193	18191	18196	18194	18192	37186		Model number
244 x r60 x 8	119 x r60 x 8	244 x r60 x 8	244/244 x r60 x 8	127/127 x r60 x 8	60 x 60 x 60			Nom. dim.
4.000	8.000							Work size mm
0.700/piece	0.340/piece	0.700/piece	1.300/pair	0.850/pair	0.100/piece	0.350/piece		m - pieces
18 pieces	36 pieces	18 pieces	9 pairs	7 pairs				Pce./pair - kg
4.500	4.500							Bundle - pce./pair
12.600	12.240	12.600	11.700	5.950				Bundle - m
								Bundle - kg
								Pallet - m
								Pallet - kg
Alb	Alb	Alb	Alb	Alb	Alb	Alb		Product standard
700-18190	700-18193	700-18191	700-18196	700-18194	700-18192	700-37186	4	neutral 10
Price gr. A458 (pce.)	Price gr. A438 (pce.)	Price gr. A471 (pce.)	Price gr. A506 (pair)	Price gr. A506 (pair)	Price gr. A449 (pce.)	Price gr. A528 (pce.)		(active white glossy)
701-18190	701-18193	701-18191	701-18196	701-18194	701-18192	701-37186	4	neutral 10
Price gr. A458 (pce.)	Price gr. A438 (pce.)	Price gr. A471 (pce.)	Price gr. A506 (pair)	Price gr. A506 (pair)	Price gr. A449 (pce.)	Price gr. A528 (pce.)		(active white matt)
552001-18190	552001-18193	552001-18191	552001-18196	552001-18194	552001-18192	552001-37186	2	active azure
Price gr. A443 (pce.)	Price gr. A441 (pce.)	Price gr. A475 (pce.)	Price gr. A511 (pair)	Price gr. A511 (pair)	Price gr. A452 (pce.)	Price gr. A539 (pce.)		
552002-18190	552002-18193	552002-18191	552002-18196	552002-18194	552002-18192	552002-37186	4	light azure
Price gr. A463 (pce.)	Price gr. A441 (pce.)	Price gr. A475 (pce.)	Price gr. A511 (pair)	Price gr. A511 (pair)	Price gr. A452 (pce.)	Price gr. A539 (pce.)		
5716-18190³	5716-18193³	5716-18191³	5716-18196³	5716-18194³	5716-18192³	5716-37186³	1	neutral 1
Price gr. A463 (pce.)	Price gr. A441 (pce.)	Price gr. A475 (pce.)	Price gr. A511 (pair)	Price gr. A511 (pair)	Price gr. A452 (pce.)	Price gr. A539 (pce.)		(deep black)
900-18190²	900-18193²	900-18191²	900-18196²	900-18194²	900-18192²	900-37186²		grey-beige
Price gr. A467 (pce.)	Price gr. A445 (pce.)	Price gr. A480 (pce.)	Price gr. A519 (pair)	Price gr. A519 (pair)	Price gr. A455 (pce.)	Price gr. A545 (pce.)		

²  Make-to-order production: return and/or cancellation of ordered products not possible.

³ For reasons of production, differences in color between special pieces and standard tiles can occur.

All products: Color Shade Variation V0

 The products shown on this page can also be produced in other colors of the series Chroma. We will be pleased to check the possibility of such a special production upon request.



Cove skirtings

25 x 6.6 cm



25 x 12.5 cm



	Berlin skirting	External angle	Internal angle	Skirting, r = 12 mm	External angle mitred pair	Internal angle mitred pair	
Model number	37090	37091	37092	37080	37081	37082	
Nom. dim. - cm/in	25 x 6.6 / 10 x 2 5/8			25 x 12.5 / 10 x 5			
Work size mm	244 x 60/8 x 6	(2x) 35 x 60/8 x 6	(2x) 25 x 60/8 x 6	244 x 125/12 x 8	(2x) 131 x 125/12 x 8	(2x) 119 x 125/12 x 8	
m - pieces	4.000			4.000			
Pce./pair - kg	0.230/piece	0.100/piece	0.100/piece	0.630/piece	0.600/pair	0.400/pair	
Bundle - pce./pair	40 pieces	72 pieces	192 pieces	20 pieces	10 pairs	10 pairs	
Bundle - m	10.000			5.000			
Bundle - kg	9.200	7.200	19.200	12.600	6.000	4.000	
Pallet - m							
Pallet - kg							
Product standard	Alb	Alb	Alb	Alb	Alb	Alb	
neutral 10	4			700-37080	700-37081	700-37082	
(active white glossy)				Price gr. A434 (pce.)	Price gr. A475 (pair)	Price gr. A475 (pair)	
neutral 10	4			701-37080	701-37081	701-37082	
(active white matt)	Price gr. A434 (pce.)	Price gr. A463 (pce.)	Price gr. A463 (pce.)	Price gr. A434 (pce.)	Price gr. A475 (pair)	Price gr. A475 (pair)	



Skirtings

20 x 7.9 cm



25 x 7.9 cm



30 x 7.9 cm



Nosing Tiles

25 x 6.2 cm



20 x 10 cm



25 x 12.5 cm



	44025	34020	44026	37024	37023	37021	
Model number	44025	34020	44026	37024	37023	37021	
Nom. dim. - cm/in	20 x 7.9 / 8 x 3 1/8	25 x 7.9 / 10 x 3 1/8	30 x 7.9 / 12 x 3 1/8	25 x 6.2 / 10 x 2 1/2	20 x 10 / 8 x 4	25 x 12.5 / 10 x 5	
Work size mm	194 x 73 x 8	244 x 73 x 8	294 x 73 x 8	244 x 56/56 x 8	194 x 94/56 x 8	244 x 119/56 x 8	
m - pieces	5.000	4.000	3.333	4.000	5.000	4.000	
Pieces - kg	0.240	0.290	0.360	0.440	0.510	0.730	
Bundle - pieces	33	33	30	24	10	10	
Bundle - m	6.600	8.250	9.000	6.000	2.000	2.500	
Bundle - kg	7.920	9.570	10.800	10.560	5.100	7.300	
Pallet - m							
Pallet - kg							
Product standard	Alb	Alb	Alb	Alb	Alb	Alb	
neutral 10	4			700-37024	700-37023	700-37021	
(active white glossy)				Price gr. A423 (pce.)	Price gr. A434 (pce.)	Price gr. A441 (pce.)	
neutral 10	4			701-37024	701-37023	701-37021	
(active white matt)	Price gr. A410 (pce.)	Price gr. A410 (pce.)	Price gr. A411 (pce.)	Price gr. A423 (pce.)	Price gr. A434 (pce.)	Price gr. A441 (pce.)	



All products: Color Shade Variation V0

 The products shown on this page can also be produced in other colors of the series Chroma. We will be pleased to check the possibility of such a special production upon request.

Radius 30 mm



Profiled edging, r = 30 mm	"half-size" profiled edging	Corner piece	External angle for the connection of skirting 17190 and profiled edging 37120	External angle for the connection of cove skirting 37080 and profiled edging 37120	Internal angle for the connection of skirting 17190 and profiled edging 37120	Stress group	Model number
37120	37121	37122	37180	37188	37182		Nom. dim. - cm
244 x r30 x 8	119 x r30 x 8						Work size mm
4.000	8.000						m - pieces
0.190	0.100	0.030	0.120	0.300	0.090		Pieces - kg
99	198						Bundle - pieces
24.750	24.750						Bundle - m
18.810	19.800						Bundle - kg
							Pallet - m
							Pallet - kg
Alb	Alb	Alb	Alb	Alb	Alb		Product standard
see below	see below	see below	see below	see below	see below		Slip resistance
700-37120	700-37121	700-37122	700-37180	700-37188	700-37182	4	neutral 10
Price gr. A438 (pce.)	Price gr. A423 (pce.)	Price gr. A467 (pce.)	Price gr. A480 (pce.)	Price gr. A519 (pce.)	Price gr. A519 (pce.)		(active white glossy)
701-37120	701-37121	701-37122	701-37180	701-37188	701-37182	4	neutral 10
Price gr. A438 (pce.)	Price gr. A423 (pce.)	Price gr. A467 (pce.)	Price gr. A480 (pce.)	Price gr. A519 (pce.)	Price gr. A519 (pce.)		(active white matt)
552001-37120	552001-37121	552001-37122	552001-37180	552001-37188	552001-37182	2	active azure
Price gr. A441 (pce.)	Price gr. A425 (pce.)	Price gr. A471 (pce.)	Price gr. A484 (pce.)	Price gr. A528 (pce.)	Price gr. A528 (pce.)		
552002-37120	552002-37121	552002-37122	552002-37180	552002-37188	552002-37182	4	light azure
Price gr. A441 (pce.)	Price gr. A425 (pce.)	Price gr. A471 (pce.)	Price gr. A484 (pce.)	Price gr. A528 (pce.)	Price gr. A528 (pce.)		
5716-37120²	5716-37121²	5716-37122²	5716-37180²	5716-37188²	5716-37182²	1	neutral 1
Price gr. A441 (pce.)	Price gr. A425 (pce.)	Price gr. A471 (pce.)	Price gr. A484 (pce.)	Price gr. A528 (pce.)	Price gr. A528 (pce.)		(deep black)
-/B	-/B	-/B	-/B	-/B	-/B		
91-37120	91-37121	91-37122	91-37180	91-37188	91-37182		neutral 10
Price gr. A445 (pce.)	Price gr. A428 (pce.)	Price gr. A475 (pce.)	Price gr. A489 (pce.)	Price gr. A539 (pce.)	Price gr. A539 (pce.)		(active white)
-/B	-/B	-/B	-/B	-/B	-/B		
553001-37120	553001-37121	553001-37122	553001-37180	553001-37188	553001-37182		active azure
Price gr. A449 (pce.)	Price gr. A430 (pce.)	Price gr. A480 (pce.)	Price gr. A506 (pce.)	Price gr. A545 (pce.)	Price gr. A545 (pce.)		
-/B	-/B	-/B	-/B	-/B	-/B		
553002-37120	553002-37121	553002-37122	553002-37180	553002-37188	553002-37182		light azure
Price gr. A449 (pce.)	Price gr. A430 (pce.)	Price gr. A480 (pce.)	Price gr. A506 (pce.)	Price gr. A545 (pce.)	Price gr. A545 (pce.)		
-/B	-/B	-/B	-/B	-/B	-/B		
340-37120	340-37121	340-37122	340-37180	340-37188	340-37182		neutral 1
Price gr. A449 (pce.)	Price gr. A430 (pce.)	Price gr. A480 (pce.)	Price gr. A506 (pce.)	Price gr. A545 (pce.)	Price gr. A545 (pce.)		(deep black)
-/C	-/C	-/C	-/C	-/C	-/C		
81-37120	81-37121	81-37122	81-37180	81-37188	81-37182		neutral 10
Price gr. A445 (pce.)	Price gr. A428 (pce.)	Price gr. A475 (pce.)	Price gr. A489 (pce.)	Price gr. A539 (pce.)	Price gr. A539 (pce.)		(active white)
-/C	-/C	-/C	-/C	-/C	-/C		
554001-37120	554001-37121	554001-37122	554001-37180	554001-37188	554001-37182		active azure
Price gr. A449 (pce.)	Price gr. A430 (pce.)	Price gr. A480 (pce.)	Price gr. A506 (pce.)	Price gr. A545 (pce.)	Price gr. A545 (pce.)		
-/C	-/C	-/C	-/C	-/C	-/C		
554002-37120	554002-37121	554002-37122	554002-37180	554002-37188	554002-37182		light azure
Price gr. A449 (pce.)	Price gr. A430 (pce.)	Price gr. A480 (pce.)	Price gr. A506 (pce.)	Price gr. A545 (pce.)	Price gr. A545 (pce.)		
-/C	-/C	-/C	-/C	-/C	-/C		
554111-37120	554111-37121	554111-37122	554111-37180	554111-37188	554111-37182		neutral 1
Price gr. A449 (pce.)	Price gr. A430 (pce.)	Price gr. A480 (pce.)	Price gr. A506 (pce.)	Price gr. A545 (pce.)	Price gr. A545 (pce.)		(deep black)
R10/A	R10/A	R10/A	R10/A	R10/A	R10/A		
900-37120¹	900-37121¹	900-37122¹	900-37180¹	900-37188¹	900-37182¹		grey-beige
Price gr. A438 (pce.)	Price gr. A423 (pce.)	Price gr. A467 (pce.)	Price gr. A480 (pce.)	Price gr. A519 (pce.)	Price gr. A519 (pce.)		

¹ Make-to-order production: return and/or cancellation of ordered products not possible.

² For reasons of production, differences in color between special pieces and standard tiles can occur.

All products: Color Shade Variation V0

The products shown on this page can also be produced in other colors of the series Chroma and Chroma non-slip. We will be pleased to check the possibility of such a special production upon request.





Radius 60 mm



Profiled edging, r = 60 mm

"half-size" profiled edging

Corner piece

External angle for the connection of skirting 17190 and profiled edging 37125

External angle for the connection of cove skirting 37080 and profiled edging 37125

Internal angle for the connection of skirting 17190 and profiled edging 37125

Model number	37125	37126	37127	37183	37189	37185
Nom. dim. - cm						
Work size mm	244 x r60 x 8	119 x r60 x 8				
m - pieces	4.000	8.000				
Pieces - kg	0.380	0.190	0.100	0.250	0.300	0.200
Bundle - pieces	24	48				
Bundle - m	6.000	6.000				
Bundle - kg	9.120	9.120				
Pallet - m						
Pallet - kg						
Product standard	Alb	Alb	Alb	Alb	Alb	Alb
Slip resistance	see below	see below	see below	see below	see below	see below
Stress group						
neutral 10 (active white glossy)	4 700-37125 Price gr. A467 (pce.)	700-37126 Price gr. A438 (pce.)	700-37127 Price gr. A511 (pce.)	700-37183 Price gr. A511 (pce.)	700-37189 Price gr. A533 (pce.)	700-37185 Price gr. A533 (pce.)
neutral 10 (active white matt)	4 701-37125 Price gr. A467 (pce.)	701-37126 Price gr. A438 (pce.)	701-37127 Price gr. A511 (pce.)	701-37183 Price gr. A511 (pce.)	701-37189 Price gr. A533 (pce.)	701-37185 Price gr. A533 (pce.)
active azure	2 552001-37125 Price gr. A471 (pce.)	552001-37126 Price gr. A441 (pce.)	552001-37127 Price gr. A519 (pce.)	552001-37183 Price gr. A519 (pce.)	552001-37189 Price gr. A545 (pce.)	552001-37185 Price gr. A545 (pce.)
light azure	4 552002-37125 Price gr. A471 (pce.)	552002-37126 Price gr. A441 (pce.)	552002-37127 Price gr. A519 (pce.)	552002-37183 Price gr. A519 (pce.)	552002-37189 Price gr. A545 (pce.)	552002-37185 Price gr. A545 (pce.)
neutral 1 (deep black)	1 5716-37125² Price gr. A471 (pce.)	5716-37126² Price gr. A441 (pce.)	5716-37127² Price gr. A519 (pce.)	5716-37183² Price gr. A519 (pce.)	5716-37189² Price gr. A545 (pce.)	5716-37185² Price gr. A545 (pce.)
neutral 10 (active white)	/B 91-37125 Price gr. A475 (pce.)	/B 91-37126 Price gr. A445 (pce.)	/B 91-37127 Price gr. A528 (pce.)	/B 91-37183 Price gr. A528 (pce.)	/B 91-37189 Price gr. A556 (pce.)	/B 91-37185 Price gr. A556 (pce.)
active azure	/B 553001-37125 Price gr. A480 (pce.)	/B 553001-37126 Price gr. A449 (pce.)	/B 553001-37127 Price gr. A539 (pce.)	/B 553001-37183 Price gr. A539 (pce.)	/B 553001-37189 Price gr. A573 (pce.)	/B 553001-37185 Price gr. A573 (pce.)
light azure	/B 553002-37125 Price gr. A480 (pce.)	/B 553002-37126 Price gr. A449 (pce.)	/B 553002-37127 Price gr. A539 (pce.)	/B 553002-37183 Price gr. A539 (pce.)	/B 553002-37189 Price gr. A573 (pce.)	/B 553002-37185 Price gr. A573 (pce.)
neutral 1 (deep black)	/B 340-37125 Price gr. A480 (pce.)	/B 340-37126 Price gr. A449 (pce.)	/B 340-37127 Price gr. A539 (pce.)	/B 340-37183 Price gr. A539 (pce.)	/B 340-37189 Price gr. A573 (pce.)	/B 340-37185 Price gr. A573 (pce.)
neutral 10 (active white)	/C 81-37125 Price gr. A475 (pce.)	/C 81-37126 Price gr. A445 (pce.)	/C 81-37127 Price gr. A528 (pce.)	/C 81-37183 Price gr. A528 (pce.)	/C 81-37189 Price gr. A556 (pce.)	/C 81-37185 Price gr. A556 (pce.)
active azure	/C 554001-37125 Price gr. A480 (pce.)	/C 554001-37126 Price gr. A449 (pce.)	/C 554001-37127 Price gr. A539 (pce.)	/C 554001-37183 Price gr. A539 (pce.)	/C 554001-37189 Price gr. A573 (pce.)	/C 554001-37185 Price gr. A573 (pce.)
light azure	/C 554002-37125 Price gr. A480 (pce.)	/C 554002-37126 Price gr. A449 (pce.)	/C 554002-37127 Price gr. A539 (pce.)	/C 554002-37183 Price gr. A539 (pce.)	/C 554002-37189 Price gr. A573 (pce.)	/C 554002-37185 Price gr. A573 (pce.)
neutral 1 (deep black)	/C 554111-37125 Price gr. A480 (pce.)	/C 554111-37126 Price gr. A449 (pce.)	/C 554111-37127 Price gr. A539 (pce.)	/C 554111-37183 Price gr. A539 (pce.)	/C 554111-37189 Price gr. A573 (pce.)	/C 554111-37185 Price gr. A573 (pce.)
grey-beige	R10/A 900-37125¹ Price gr. A467 (pce.)	R10/A 900-37126¹ Price gr. A438 (pce.)	R10/A 900-37127¹ Price gr. A511 (pce.)	R10/A 900-37183¹ Price gr. A511 (pce.)	R10/A 900-37189¹ Price gr. A533 (pce.)	R10/A 900-37185¹ Price gr. A533 (pce.)



¹ Make-to-order production: return and/or cancellation of ordered products not possible.

² For reasons of production, differences in color between special pieces and standard tiles can occur.

All products: Color Shade Variation V0

The products shown on this page can also be produced in other colors of the series Chroma and Chroma non-slip. We will be pleased to check the possibility of such a special production upon request.

Project: Ågeribad / Architect: Scheitlin Syfrig Architekten AG / Series: Chroma, Chroma unglazed - Quantum, Loop, Plural non-slip / Photo: Adriano Faragulo



432 GROOVED TILES

Project: Leisure pool / Location: Baesweiler, Germany / Architect: Planteam Ruhr / Series: Pool edge system Wiesbaden, Valley / Photo: Jochen Stüber





For a safe foothold

Grooved tiles are used above all in those areas where there is an increased risk of falling for the bathers. Their grooved, particularly slip-resistant surface ensures a safe foothold, for example at stair edges, and prevents slipping. At the same time, these tiles send a clear signal to the user already by their haptics and usually contrasting color: watch out! Stairs leading into the water or permanently wet stairs and the marking of edges are typical areas for the use of grooved tiles. However, they are also suitable for haptic and visual delimitations or as orientation aids for visually impaired bathers.

8 mm thick, e.g. for stairs leading into the water and other wet stairs in indoor swimming pools

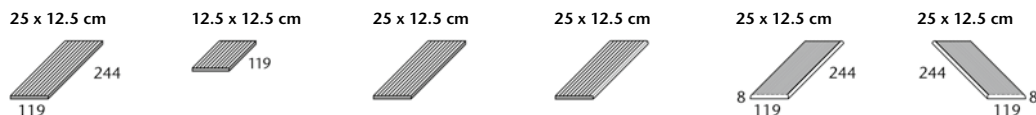

	grooved	"Half-size" tile, grooved	Grooved short side rounded	Grooved long side rounded	Grooved Corner left, rounded	Grooved Corner right, rounded
Model number	34100	34109	34105	34106	34107	34108
Nom. dim. - cm/in	25 x 12.5 / 10 x 5	12.5 x 12.5 / 5 x 5	25 x 12.5 / 10 x 5	25 x 12.5 / 10 x 5	25 x 12.5 / 10 x 5	25 x 12.5 / 10 x 5
Work size	244 x 119 x 8 mm	119 x 119 x 8 mm	244 x 119 x 8 mm	244 x 119 x 8 mm	244 x 119 x 8 mm	244 x 119 x 8 mm
m - pieces	4.000	8.000	4.000	4.000	4.000	4.000
Pieces - kg	0.460	0.230	0.460	0.460	0.460	0.460
Bundle - pieces	33	66	33	33	33	33
Bundle - m	8.250	8.250	8.250	8.250	8.250	8.250
Bundle - kg	15.180	15.180	15.180	15.180	15.180	15.180
Pallet - m						
Pallet - kg						
Product standard	Alb	Alb	Alb	Alb	Alb	Alb
Slip resistance	-/C	-/C	-/C	-/C	-/C	-/C
	900-34100	900-34109	900-34105	900-34106	900-34107	900-34108
grey-beige	Price gr. A410 (pce.)	Price gr. A406 (pce.)	Price gr. A413 (pce.)	Price gr. A413 (pce.)	Price gr. A418 (pce.)	Price gr. A418 (pce.)
neutral 10	91i-34100H¹ ☒	91i-34109H¹ ☒	91i-34105H¹ ☒	91i-34106H¹ ☒	91i-34107H¹ ☒	91i-34108H¹ ☒
(active white)	Price gr. A423 (pce.)	Price gr. A413 (pce.)	Price gr. A434 (pce.)	Price gr. A434 (pce.)	Price gr. A445 (pce.)	Price gr. A445 (pce.)



¹ with Hytect

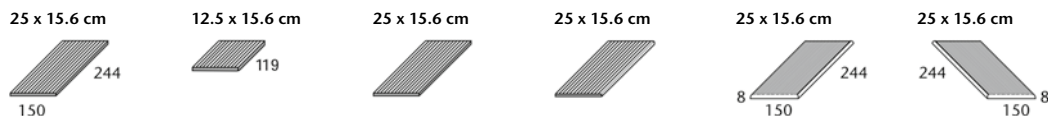

	grooved	"Half-size" tile, grooved	Grooved short side rounded	Grooved long side rounded	Grooved Corner left, rounded	Grooved Corner right, rounded
Model number	34110	34119	34115	34116	34117	34118
Nom. dim. - cm/in	25 x 15.6 / 10 x 6 1/4	12.5 x 15.6 / 5 x 6 1/4	25 x 15.6 / 10 x 6 1/4	25 x 15.6 / 10 x 6 1/4	25 x 15.6 / 10 x 6 1/4	25 x 15.6 / 10 x 6 1/4
Work size	244 x 150 x 8 mm	119 x 150 x 8 mm	244 x 150 x 8 mm	244 x 150 x 8 mm	244 x 150 x 8 mm	244 x 150 x 8 mm
m - pieces	4.000	8.000	4.000	4.000	4.000	4.000
Pieces - kg	0.580	0.280	0.580	0.580	0.580	0.580
Bundle - pieces	33	66	33	33	33	33
Bundle - m	8.250	8.250	8.250	8.250	8.250	8.250
Bundle - kg	19.140	18.480	19.140	19.140	19.140	19.140
Pallet - m						
Pallet - kg						
Product standard	Alb	Alb	Alb	Alb	Alb	Alb
Slip resistance	-/C	-/C	-/C	-/C	-/C	-/C
	900-34110	900-34119	900-34115	900-34116	900-34117	900-34118
grey-beige	Price gr. A425 (pce.)	Price gr. A413 (pce.)	Price gr. A434 (pce.)	Price gr. A434 (pce.)	Price gr. A445 (pce.)	Price gr. A445 (pce.)
neutral 10	91i-34110H¹ ☒	91i-34119H¹ ☒	91i-34115H¹ ☒	91i-34116H¹ ☒	91i-34117H¹ ☒	91i-34118H¹ ☒
(active white)	Price gr. A452 (pce.)	Price gr. A434 (pce.)	Price gr. A475 (pce.)	Price gr. A475 (pce.)	Price gr. A506 (pce.)	Price gr. A506 (pce.)



¹ with Hytect

No pallet rebate is granted for the products shown on this page.

All products: Color Shade Variation V0

The products shown on this page can also be produced in other colors of the series Chroma non-slip. We will be pleased to check the possibility of such a special production upon request.

Rounded corners			rounded corners
Replace last figure 0 of standard model no. by 7 = corner left	... 8 = corner right	Example: Standard model no. 34100 = 244 x 119 x 8 mm, Model no. 34107 = rounded corner left

8 mm thick, with non-slip safety marking

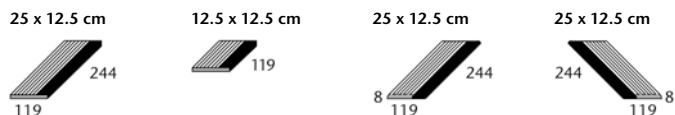

			34146H	34149H	34147H	34148H		Model number
			25 x 12.5 / 10 x 5	12.5 x 12.5 / 5 x 5	25 x 12.5 / 10 x 5	25 x 12.5 / 10 x 5		Nom. dim. - cm/in
			244 x 119 x 8 mm	119 x 119 x 8 mm	244 x 119 x 8 mm	244 x 119 x 8 mm		Work size
			4.000	8.000	4.000	4.000		m - pieces
			0.460	0.230	0.460	0.460		Pieces - kg
			33	66	33	33		Bundle - pieces
			8.250	8.250	8.250	8.250		Bundle - m
			15.180	15.180	15.180	15.180		Bundle - kg
								Pallet - m
								Pallet - kg
			Alb	Alb	Alb	Alb		Product standard
			-/C	-/C	-/C	-/C		Slip resistance
			553001-34146H	553001-34149H	553001-34147H	553001-34148H		900 grey-beige
			Price gr. A423 (pce.)	Price gr. A413 (pce.)	Price gr. A430 (pce.)	Price gr. A430 (pce.)		553001 active azure
			553002-34146H	553002-34149H	553002-34147H	553002-34148H		900 grey-beige
			Price gr. A423 (pce.)	Price gr. A413 (pce.)	Price gr. A430 (pce.)	Price gr. A430 (pce.)		553002 light azure
			340i-34146H	340i-34149H	340i-34147H	340i-34148H		900 grey-beige
			Price gr. A423 (pce.)	Price gr. A413 (pce.)	Price gr. A430 (pce.)	Price gr. A430 (pce.)		340 n1/black
			900567-34146H	900567-34149H	900567-34147H	900567-34148H		91 n10/white
			Price gr. A445 (pce.)	Price gr. A434 (pce.)	Price gr. A456 (pce.)	Price gr. A456 (pce.)		553001 active azure
			900588-34146H	900588-34149H	900588-34147H	900588-34148H		91 n10/white
			Price gr. A445 (pce.)	Price gr. A434 (pce.)	Price gr. A456 (pce.)	Price gr. A456 (pce.)		553002 light azure
			900044-34146H	900044-34149H	900044-34147H	900044-34148H		91 n10/white
			Price gr. A445 (pce.)	Price gr. A434 (pce.)	Price gr. A456 (pce.)	Price gr. A456 (pce.)		340 n1/black

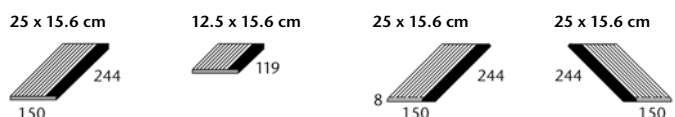

			34156H	34159H	34157H	34158H		Model number
			25 x 15.6 / 10 x 6 1/4	12.5 x 15.6 / 5 x 6 1/4	25 x 15.6 / 10 x 6 1/4	25 x 15.6 / 10 x 6 1/4		Nom. dim. - cm/in
			244 x 150 x 8 mm	119 x 150 x 8 mm	244 x 150 x 8 mm	244 x 150 x 8 mm		Work size
			4.000	8.000	4.000	4.000		m - pieces
			0.580	0.280	0.580	0.580		Pieces - kg
			33	66	33	33		Bundle - pieces
			8.250	8.250	8.250	8.250		Bundle - m
			19.140	18.480	19.140	19.140		Bundle - kg
								Pallet - m
								Pallet - kg
			Alb	Alb	Alb	Alb		Product standard
			-/C	-/C	-/C	-/C		Slip resistance
			553001-34156H	553001-34159H	553001-34157H	553001-34158H		900 grey-beige
			Price gr. A438 (pce.)	Price gr. A423 (pce.)	Price gr. A449 (pce.)	Price gr. A449 (pce.)		553001 active azure
			553002-34156H	553002-34159H	553002-34157H	553002-34158H		900 grey-beige
			Price gr. A438 (pce.)	Price gr. A423 (pce.)	Price gr. A449 (pce.)	Price gr. A449 (pce.)		553002 light azure
			340i-34156H	340i-34159H	340i-34157H	340i-34158H		900 grey-beige
			Price gr. A438 (pce.)	Price gr. A423 (pce.)	Price gr. A449 (pce.)	Price gr. A449 (pce.)		340 n1/black
			900567-34156H	900567-34159H	900567-34157H	900567-34158H		91 n10/white
			Price gr. A480 (pce.)	Price gr. A445 (pce.)	Price gr. A506 (pce.)	Price gr. A506 (pce.)		553001 active azure
			900588-34156H	900588-34159H	900588-34157H	900588-34158H		91 n10/white
			Price gr. A480 (pce.)	Price gr. A445 (pce.)	Price gr. A506 (pce.)	Price gr. A506 (pce.)		553002 light azure
			900044-34156H	900044-34159H	900044-34157H	900044-34158H		91 n10/white
			Price gr. A480 (pce.)	Price gr. A445 (pce.)	Price gr. A506 (pce.)	Price gr. A506 (pce.)		340 n1/black



The products shown on this page can also be produced in other colors of the series Chroma non-slip. We will be pleased to check the possibility of such a special production upon request.

No pallet rebate is granted for the products shown on this page.

All products: Color Shade Variation V0

Rounded corners				
Replace last figure 0 of standard model no. by 7 = corner left	... 8 = corner right	rounded corners	Example: Standard model no. 34146 = 119 x 244 x 8 mm, Model no. 34147 = rounded corner left

15 mm thick, e.g. for continuing the Pool Edge System "Finland", for starting blocks etc.

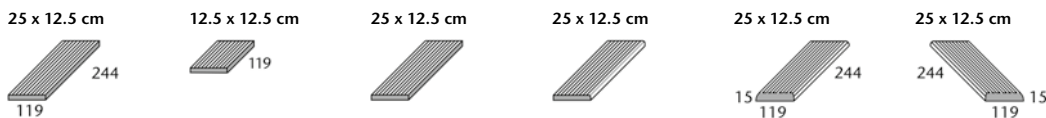

	grooved	"Half-size" tile, grooved	Grooved short side rounded	Grooved long side rounded	Grooved Corner left, rounded	Grooved Corner right, rounded
Model number	53130	53139	53135	53136	53137	53138
Nom. dim. - cm/in	25 x 12.5 / 10 x 5	12.5 x 12.5 / 5 x 5	25 x 12.5 / 10 x 5	25 x 12.5 / 10 x 5	25 x 12.5 / 10 x 5	25 x 12.5 / 10 x 5
Work size	244 x 119 x 15 mm	119 x 119 x 15 mm	244 x 119 x 15 mm	244 x 119 x 15 mm	244 x 119 x 15 mm	244 x 119 x 15 mm
m - pieces	4.000	8.000	4.000	4.000	4.000	4.000
Pieces - kg	0.830	0.420	0.830	0.830	0.830	0.830
Bundle - pieces	16	32	16	16	16	16
Bundle - m	4.000	4.000	4.000	4.000	4.000	4.000
Bundle - kg	13.280	13.440	13.280	13.280	13.280	13.280
Pallet - m						
Pallet - kg						
Product standard	Alb	Alb	Alb	Alb	Alb	Alb
Slip resistance	-/C	-/C	-/C	-/C	-/C	-/C
	900-53130	900-53139	900-53135	900-53136	900-53137	900-53138
grey-beige	Price gr. A410 (pce.)	Price gr. A406 (pce.)	Price gr. A413 (pce.)	Price gr. A413 (pce.)	Price gr. A418 (pce.)	Price gr. A418 (pce.)
neutral 10	91-53130 ☒	91-53139 ☒	91-53135 ☒	91-53136 ☒	91-53137 ☒	91-53138 ☒
(active white)	Price gr. A423 (pce.)	Price gr. A413 (pce.)	Price gr. A434 (pce.)	Price gr. A434 (pce.)	Price gr. A445 (pce.)	Price gr. A445 (pce.)

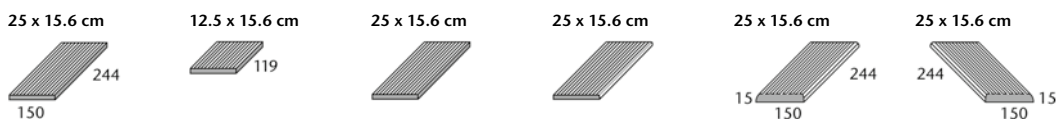



	grooved	"Half-size" tile, grooved	Grooved short side rounded	Grooved long side rounded	Grooved Corner left, rounded	Grooved Corner right, rounded
Model number	53190	53199	53195	53196	53197	53198
Nom. dim. - cm/in	25 x 15.6 / 10 x 6 1/4	12.5 x 15.6 / 5 x 6 1/4	25 x 15.6 / 10 x 6 1/4	25 x 15.6 / 10 x 6 1/4	25 x 15.6 / 10 x 6 1/4	25 x 15.6 / 10 x 6 1/4
Work size	244 x 150 x 15 mm	119 x 150 x 15 mm	244 x 150 x 15 mm	244 x 150 x 15 mm	244 x 150 x 15 mm	244 x 150 x 15 mm
m - pieces	4.000	8.000	4.000	4.000	4.000	4.000
Pieces - kg	1.000	0.490	1.000	1.000	1.000	1.000
Bundle - pieces	18	36	18	18	18	18
Bundle - m	4.500	4.500	4.500	4.500	4.500	4.500
Bundle - kg	18.000	17.640	18.000	18.000	18.000	18.000
Pallet - m						
Pallet - kg						
Product standard	Alb	Alb	Alb	Alb	Alb	Alb
Slip resistance	-/C	-/C	-/C	-/C	-/C	-/C
	900-53190	900-53199	900-53195	900-53196	900-53197	900-53198
grey-beige	Price gr. A425 (pce.)	Price gr. A413 (pce.)	Price gr. A434 (pce.)	Price gr. A434 (pce.)	Price gr. A445 (pce.)	Price gr. A445 (pce.)
neutral 10	91-53190 ☒	91-53199 ☒	91-53195 ☒	91-53196 ☒	91-53197 ☒	91-53198 ☒
(active white)	Price gr. A452 (pce.)	Price gr. A434 (pce.)	Price gr. A475 (pce.)	Price gr. A475 (pce.)	Price gr. A506 (pce.)	Price gr. A506 (pce.)



No pallet rebate is granted for the products shown on this page.

All products: Color Shade Variation V0

 The products shown on this page can also be produced in other colors of the series Chroma non-slip. We will be pleased to check the possibility of such a special production upon request.

Rounded corners				
Replace last figure 0 of standard model no. by 7 = corner left	... 8 = corner right	rounded corners	Example: Standard model no. 53130 = 119 x 244 x 15 mm, Model no. 53137 = rounded corner left

15 mm thick, with non-slip safety marking

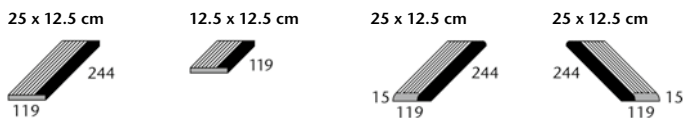

			25 x 12.5 cm	12.5 x 12.5 cm	25 x 12.5 cm	25 x 12.5 cm	Model number
			Grooved long side rounded	"Half-size" tile grooved, long side rounded	Grooved corner left, rounded	Grooved corner right, rounded	Nom. dim. - cm/in
			59620	59629	59627	59628	Work size
			25 x 12.5 / 10 x 5	12.5 x 12.5 / 5 x 5	25 x 12.5 / 10 x 5	25 x 12.5 / 10 x 5	m - pieces
			244 x 119 x 15 mm	119 x 119 x 15 mm	244 x 119 x 15 mm	244 x 119 x 15 mm	Pieces - kg
			4.000	8.000	4.000	4.000	Bundle - pieces
			0.830	0.420	0.830	0.830	Bundle - m
			16	32	16	16	Bundle - kg
			4.000	4.000	4.000	4.000	Pallet - m
			13.280	13.440	13.280	13.280	Pallet - kg
			Alb	Alb	Alb	Alb	Product standard
			-/C	-/C	-/C	-/C	Slip resistance
			553001-59620	553001-59629	553001-59627	553001-59628	900 grey-beige
			Price gr. A423 (pce.)	Price gr. A413 (pce.)	Price gr. A430 (pce.)	Price gr. A430 (pce.)	553001 active azure
			553002-59620	553002-59629	553002-59627	553002-59628	900 grey-beige
			Price gr. A423 (pce.)	Price gr. A413 (pce.)	Price gr. A430 (pce.)	Price gr. A430 (pce.)	553002 light azure
			340-59620	340-59629	340-59627	340-59628	900 grey-beige
			Price gr. A423 (pce.)	Price gr. A413 (pce.)	Price gr. A430 (pce.)	Price gr. A430 (pce.)	340 n1/black
			900567-59620	900567-59629	900567-59627	900567-59628	91 n10/white
			Price gr. A445 (pce.)	Price gr. A434 (pce.)	Price gr. A456 (pce.)	Price gr. A456 (pce.)	553001 active azure
			900588-59620	900588-59629	900588-59627	900588-59628	91 n10/white
			Price gr. A445 (pce.)	Price gr. A434 (pce.)	Price gr. A456 (pce.)	Price gr. A456 (pce.)	553002 light azure
			900044-59620	900044-59629	900044-59627	900044-59628	91 n10/white
			Price gr. A445 (pce.)	Price gr. A434 (pce.)	Price gr. A456 (pce.)	Price gr. A456 (pce.)	340 n1/black

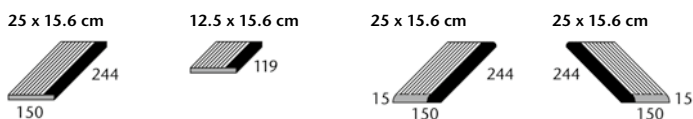



			25 x 15.6 cm	12.5 x 15.6 cm	25 x 15.6 cm	25 x 15.6 cm	Model number
			Grooved long side rounded	"Half-size" tile grooved, long side rounded	Grooved corner left, rounded	Grooved corner right, rounded	Nom. dim. - cm/in
			59630	59639	59637	59638	Work size
			25 x 15.6 / 10 x 6 1/4	12.5 x 15.6 / 5 x 6 1/4	25 x 15.6 / 10 x 6 1/4	25 x 15.6 / 10 x 6 1/4	m - pieces
			244 x 150 x 15 mm	119 x 150 x 15 mm	244 x 150 x 15 mm	244 x 150 x 15 mm	Pieces - kg
			4.000	8.000	4.000	4.000	Bundle - pieces
			1.000	0.490	1.000	1.000	Bundle - m
			18	36	18	18	Bundle - kg
			4.500	4.500	4.500	4.500	Pallet - m
			18.000	17.640	18.000	18.000	Pallet - kg
			Alb	Alb	Alb	Alb	Product standard
			-/C	-/C	-/C	-/C	Slip resistance
			553001-59630	553001-59639	553001-59637	553001-59638	900 grey-beige
			Price gr. A438 (pce.)	Price gr. A423 (pce.)	Price gr. A449 (pce.)	Price gr. A449 (pce.)	553001 active azure
			553002-59630	553002-59639	553002-59637	553002-59638	900 grey-beige
			Price gr. A438 (pce.)	Price gr. A423 (pce.)	Price gr. A449 (pce.)	Price gr. A449 (pce.)	553002 light azure
			340-59630	340-59639	340-59637	340-59638	900 grey-beige
			Price gr. A438 (pce.)	Price gr. A423 (pce.)	Price gr. A449 (pce.)	Price gr. A449 (pce.)	340 n1/black
			900567-59630	900567-59639	900567-59637	900567-59638	91 n10/white
			Price gr. A480 (pce.)	Price gr. A445 (pce.)	Price gr. A506 (pce.)	Price gr. A506 (pce.)	553001 active azure
			900588-59630	900588-59639	900588-59637	900588-59638	91 n10/white
			Price gr. A480 (pce.)	Price gr. A445 (pce.)	Price gr. A506 (pce.)	Price gr. A506 (pce.)	553002 light azure
			900044-59630	900044-59639	900044-59637	900044-59638	91 n10/white
			Price gr. A480 (pce.)	Price gr. A445 (pce.)	Price gr. A506 (pce.)	Price gr. A506 (pce.)	340 n1/black

 The products shown on this page can also be produced in other colors of the series Chroma non-slip. We will be pleased to check the possibility of such a special production upon request.

No pallet rebate is granted for the products shown on this page.



All products: Color Shade Variation V0

Rounded corners				
Replace last figure 0 of standard model no. by 7 = corner left	... 8 = corner right	rounded corners	Example: Standard model no. 59620 = 119 x 244 x 15 mm, Model no. 59627 = rounded corner left

Project: Solebad / Location: Werne, Germany / Architect: Geising + Böker GmbH / Series: Pool edge system Finnland, Chroma, Quarzit / Photo: Jochen Stüber



WT. 2.2



Ceramic specialists

The construction of swimming pools requires some very special solutions which cannot be used in any other area of application and which a premium supplier of swimming pool ceramics should have in its product range in order to cover the full spectrum of requirements of swimming pool architecture with a holistic programme. This includes stair tread tiles for pool ladders, letter tiles for indicating pool depths or for marking non-swimmer sections, or gutter tiles for the drainage of areas. All these special tiles are details, which can be found in almost every swimming pool and which would otherwise only be realizable by changing the material, e.g. to stainless steel.

Stair Tiles with non-slip safety marking

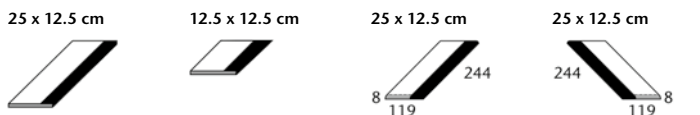

Stair tread, long side rounded "Half-size" stair tread, long side rounded Stair tread, corner left, rounded Stair tread, corner right, rounded

Model number	34166H	34169H	34167H	34168H			
Nom. dim. - cm/in	25 x 12.5 / 10 x 5	12.5 x 12.5 / 5 x 5	25 x 12.5 / 10 x 5	25 x 12.5 / 10 x 5			
Work size	244 x 119 x 8 mm	119 x 119 x 8 mm	244 x 119 x 8 mm	244 x 119 x 8 mm			
m - pieces	4.000	8.000	4.000	4.000			
Pieces - kg	0.490	0.240	0.490	0.490			
Bundle - pieces	33	66	33	33			
Bundle - m	8.250	8.250	8.250	8.250			
Bundle - kg	16.170	15.840	16.170	16.170			
Pallet - m							
Pallet - kg							
Product standard	Alb	Alb	Alb	Alb			
Slip resistance	-/C	-/C	-/C	-/C			
81 n10/white	900568-34166H	900568-34169H	900568-34167H	900568-34168H			
554001 active azure	Price gr. A445 (pce.)	Price gr. A425 (pce.)	Price gr. A456 (pce.)	Price gr. A456 (pce.)			
81 n10/white	900671-34166H	900671-34169H	900671-34167H	900671-34168H			
554002 light azure	Price gr. A445 (pce.)	Price gr. A425 (pce.)	Price gr. A456 (pce.)	Price gr. A456 (pce.)			
81 n10/white	900634-34166H	900634-34169H	900634-34167H	900634-34168H			
554111 n1/black	Price gr. A445 (pce.)	Price gr. A425 (pce.)	Price gr. A456 (pce.)	Price gr. A456 (pce.)			



Stair Tiles with non-slip safety marking

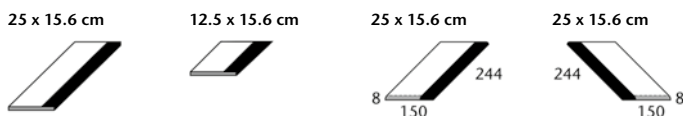

Stair tread, long side rounded "Half-size" stair tread, long side rounded Stair tread, corner left, rounded Stair tread, corner right, rounded

Model number	34136H	34139H	34137H	34138H			
Nom. dim. - cm/in	25 x 15.6 / 10 x 6 1/4	12.5 x 15.6 / 5 x 6 1/4	25 x 15.6 / 10 x 6 1/4	25 x 15.6 / 10 x 6 1/4			
Work size	244 x 150 x 8 mm	119 x 150 x 8 mm	244 x 150 x 8 mm	244 x 150 x 8 mm			
m - pieces	4.000	8.000	4.000	4.000			
Pieces - kg	0.620	0.300	0.620	0.620			
Bundle - pieces	33	66	33	33			
Bundle - m	8.250	8.250	8.250	8.250			
Bundle - kg	20.460	19.800	20.460	20.460			
Pallet - m							
Pallet - kg							
Product standard	Alb	Alb	Alb	Alb			
Slip resistance	-/C	-/C	-/C	-/C			
81 n10/white	900568-34136H	900568-34139H	900568-34137H	900568-34138H			
554001 active azure	Price gr. A452 (pce.)	Price gr. A428 (pce.)	Price gr. A467 (pce.)	Price gr. A467 (pce.)			
81 n10/white	900671-34136H	900671-34139H	900671-34137H	900671-34138H			
554002 light azure	Price gr. A452 (pce.)	Price gr. A428 (pce.)	Price gr. A467 (pce.)	Price gr. A467 (pce.)			
81 n10/white	900634-34136H	900634-34139H	900634-34137H	900634-34138H			
554111 n1/black	Price gr. A452 (pce.)	Price gr. A428 (pce.)	Price gr. A467 (pce.)	Price gr. A467 (pce.)			



No pallet rebate is granted for the products shown on this page.

All products: Color Shade Variation V0

The products shown on this page can also be produced in other colors of the series Chroma non-slip. We will be pleased to check the possibility of such a special production upon request.

Rounded corners				
Replace last figure 0 of standard model no. by 7 = corner left	... 8 = corner right	rounded corners	Example: Standard model no. 34166 = 119 x 244 x 15 mm, Model no. 34167 = rounded corner left

e.g. for standing steps, ladder recesses, small radii, turning surfaces etc.

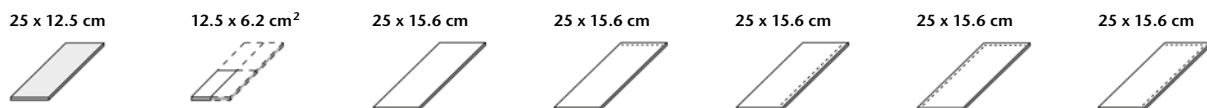

Ripple tile	Strip tile	Short side rounded	Long side rounded	Corner left, rounded	Corner right, rounded	
34170H	34070H	34120H	34125H	34126H	34127H	34128H
25 x 12.5 / 10 x 5	12.5 x 6.2 / 5 x 2 1/2	25 x 15.6 / 10 x 6 1/4	25 x 15.6 / 10 x 6 1/4	25 x 15.6 / 10 x 6 1/4	25 x 15.6 / 10 x 6 1/4	25 x 15.6 / 10 x 6 1/4
244 x 119 x 8 mm	119 x 56 x 8 mm	244 x 150 x 8 mm	244 x 150 x 8 mm	244 x 150 x 8 mm	244 x 150 x 8 mm	244 x 150 x 8 mm
32.000/m ²	128.000/m ²	25.000/m ²	6.410/m	4.000/m		
0.460	0.120	0.620	0.620	0.620	0.620	0.620
33	132	33	33	33	33	33
1.031 m ²	1.031 m ²	1.320 m ²	5.148 m	8.250 m		
15.180	15.840	20.460	20.460	20.460	20.460	20.460
Alb	Alb see below	Alb see below	Alb see below	Alb see below	Alb see below	Alb see below
700i-34170H Price gr. A304 (m ²)	700i-34070H Price gr. A244 (m ²)	700i-34120H Price gr. A211 (m ²)	700i-34125H Price gr. A416 (pce.)	700i-34126H Price gr. A416 (pce.)	700i-34127H Price gr. A423 (pce.)	700i-34128H Price gr. A423 (pce.)
701i-34170H Price gr. A304 (m ²)	701i-34070H Price gr. A244 (m ²)	701i-34120H Price gr. A211 (m ²)	701i-34125H Price gr. A416 (pce.)	701i-34126H Price gr. A416 (pce.)	701i-34127H Price gr. A423 (pce.)	701i-34128H Price gr. A423 (pce.)
552001-34170H Price gr. A337 (m ²)	552001-34070H Price gr. A277 (m ²)	552001-34120H Price gr. A250 (m ²)	552001-34125H Price gr. A419 (pce.)	552001-34126H Price gr. A419 (pce.)	552001-34127H Price gr. A425 (pce.)	552001-34128H Price gr. A425 (pce.)
552002-34170H Price gr. A337 (m ²)	552002-34070H Price gr. A277 (m ²)	552002-34120H Price gr. A250 (m ²)	552002-34125H Price gr. A419 (pce.)	552002-34126H Price gr. A419 (pce.)	552002-34127H Price gr. A425 (pce.)	552002-34128H Price gr. A425 (pce.)
5716i-34170H¹ Price gr. A346 (m ²)	5716i-34070H¹ Price gr. A277 (m ²)	5716i-34120H¹ Price gr. A250 (m ²)	5716i-34125H¹ Price gr. A419 (pce.)	5716-34126H¹ Price gr. A419 (pce.)	5716i-34127H¹ Price gr. A425 (pce.)	5716i-34128H¹ Price gr. A425 (pce.)
-/B	-/B	-/B	-/B	-/B	-/B	-/B
91i-34070H Price gr. A289 (m ²)	91i-34120H Price gr. A256 (m ²)	91i-34125H Price gr. A423 (pce.)	91i-34126H Price gr. A423 (pce.)	91i-34127H Price gr. A428 (pce.)	91i-34128H Price gr. A428 (pce.)	
-/B	-/B	-/B	-/B	-/B	-/B	-/B
553001-34070H Price gr. A298 (m ²)	553001-34120H Price gr. A265 (m ²)	553001-34125H Price gr. A425 (pce.)	553001-34126H Price gr. A425 (pce.)	553001-34127H Price gr. A430 (pce.)	553001-34128H Price gr. A430 (pce.)	
-/B	-/B	-/B	-/B	-/B	-/B	-/B
553002-34070H Price gr. A298 (m ²)	553002-34120H Price gr. A265 (m ²)	553002-34125H Price gr. A425 (pce.)	553002-34126H Price gr. A425 (pce.)	553002-34127H Price gr. A430 (pce.)	553002-34128H Price gr. A430 (pce.)	
-/B	-/B	-/B	-/B	-/B	-/B	-/B
340i-34070H Price gr. A298 (m ²)	340i-34120H Price gr. A265 (m ²)	340i-34125H Price gr. A425 (pce.)	340-34126 Price gr. A425 (pce.)	340i-34127H Price gr. A430 (pce.)	340i-34128H Price gr. A430 (pce.)	



Stress group

Model number	
Nom. dim. - cm/in	
Work size	
m ² /m - pieces	
Pieces - kg	
Bundle - pieces	
Bundle - m ² /m	
Bundle - kg	
Pallet - m ² /m	
Pallet - kg	
Product standard	
Slip resistance	
4 neutral 10 (active white glossy)	
4 neutral 10 (active white matt)	
2 active azure	
4 light azure	
1 neutral 1 (deep black)	
neutral 10 (active white)	
active azure	
light azure	
neutral 1 (deep black)	

¹ For reasons of production, differences in color between special pieces and standard tiles can occur.

² Strip tile, supplied as quadruple strip tile; to be broken by customer



Safety Strip Tiles

(especially suitable for slip-resistant and clearly visible (stair) edge design)

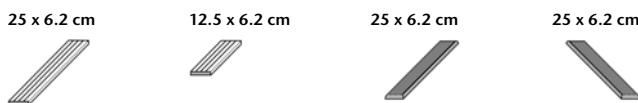

		Grooved long side rounded	"Half-size" tile grooved, long side rounded	Grooved Corner left, rounded	Grooved Corner right, rounded	
		34306	34309	34307	34308	Model number
		25 x 6.2 / 10 x 2 1/2	12.5 x 6.2 / 5 x 2 1/2	25 x 6.2 / 10 x 2 1/2	25 x 6.2 / 10 x 2 1/2	Nom. dim. - cm/in
		244 x 56 x 8 mm	119 x 56 x 8 mm	244 x 56 x 8 mm	244 x 56 x 8 mm	Work size
		4.000	8.000	4.000	4.000	m - pieces
		0.200	0.100	0.200	0.200	Pieces - kg
		66	132	66	66	Bundle - pieces
		16.500	16.500	16.500	16.500	Bundle - m
		13.200	13.200	13.200	13.200	Bundle - kg
		Alb	Alb	Alb	Alb	Pallet - m
		-/C	-/C	-/C	-/C	Pallet - kg
		91-34306	91-34309	91-34307	91-34308	Product standard
		Price gr. A431 (pce.)	Price gr. A416 (pce.)	Price gr. A434 (pce.)	Price gr. A434 (pce.)	Slip resistance
		553001-34306	553001-34309	553001-34307	553001-34308	neutral 10 (active white)
		Price gr. A434 (pce.)	Price gr. A418 (pce.)	Price gr. A438 (pce.)	Price gr. A438 (pce.)	active azure
		553002-34306	553002-34309	553002-34307	553002-34308	light azure
		Price gr. A434 (pce.)	Price gr. A418 (pce.)	Price gr. A438 (pce.)	Price gr. A438 (pce.)	neutral 1 (deep black)
		340-34306	340-34309	340-34307	340-34308	
		Price gr. A434 (pce.)	Price gr. A418 (pce.)	Price gr. A438 (pce.)	Price gr. A438 (pce.)	

The products shown on this page can also be produced in other colors of the series Chroma and Chroma non-slip. We will be pleased to check the possibility of such a special production upon request.

No pallet rebate is granted for the products shown on this page.

All products: Color Shade Variation V0



Stair Tread Tiles, tread unglazed in 900 grey-beige, grooved

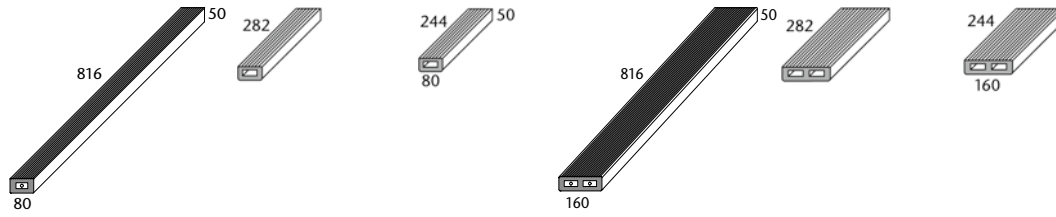

	Stair tread tile NEW	Stair tread tile	Stair tread tile	Stair tread tile NEW	Stair tread tile	Stair tread tile
Model number	55561 ²	55565 ¹	55563 ¹	55562 ²	55567 ¹	55566 ¹
Nom. dim. - cm/in						
Work size mm	816 x 80 x 50	282 x 80 x 50	244 x 80 x 50	816 x 160 x 50	282 x 160 x 50	244 x 160 x 50
m - pieces						
Pieces - kg	7.387	1.830	1.600	14.883	3.500	3.150
Bundle - pieces	1	9	10	1	4	5
Bundle - kg	7.387	16.470	16.000	14.883	14.000	15.750
Product standard	Alb	Alb	Alb	Alb	Alb	Alb
Slip resistance	-/C	-/C	-/C	-/C	-/C	-/C
900 grey-beige	700-55561	700-55565	700-55563	700-55562	700-55567	700-55566
700 n10/white gl.	Price gr. A683 (pce.)	Price gr. A593 (pce.)	Price gr. A581 (pce.)	Price gr. A705 (pce.)	Price gr. A708 (pce.)	Price gr. A698 (pce.)
900 grey-beige	701-55561	701-55565	701-55563	701-55562	701-55567	701-55566
701 n10/white matt	Price gr. A683 (pce.)	Price gr. A593 (pce.)	Price gr. A581 (pce.)	Price gr. A705 (pce.)	Price gr. A708 (pce.)	Price gr. A698 (pce.)
900 grey-beige	552001-55561	552001-55565	552001-55563	552001-55562	552001-55567	552001-55566
552001 active azure	Price gr. A683 (pce.)	Price gr. A601 (pce.)	Price gr. A587 (pce.)	Price gr. A705 (pce.)	Price gr. A716 (pce.)	Price gr. A708 (pce.)
900 grey-beige	552002-55561	552002-55565	552002-55563	552002-55562	552002-55567	552002-55566
552002 light azure	Price gr. A683 (pce.)	Price gr. A601 (pce.)	Price gr. A587 (pce.)	Price gr. A705 (pce.)	Price gr. A716 (pce.)	Price gr. A708 (pce.)
900 grey-beige	5716-55561³	5716-55565³	5716-55563³	5716-55562³	5716-55567³	5716-55566³
5716 n1/black	Price gr. A683 (pce.)	Price gr. A601 (pce.)	Price gr. A587 (pce.)	Price gr. A705 (pce.)	Price gr. A716 (pce.)	Price gr. A708 (pce.)



- ¹ In the case of these special pieces, the tread is unglazed in 900; all other surfaces are in the respective Chroma color.
- ² Prefabricated tread, cast, inclusive of reinforcement. In the case of this special piece, the tread and the back side are unglazed 900; the front and the lower side are glazed in the respective Chroma color.
- ³ For reasons of production, differences in color between special pieces and standard tiles can occur.

Letter Tiles

25 x 12.5 cm



25 x 25 cm

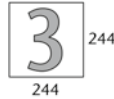

25 x 12.5 cm

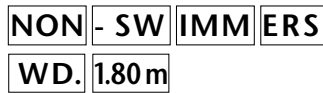

Shank-tile(as connecting piece between cover grating and pool surround)

25 x 12.5 cm

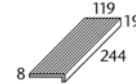

12.5 x 12.5 cm



	Number tile Type height 7 cm	Number tile Type height 20 cm	Letter tiles Type height 7 cm	Shank-tile grooved	„Half size“ shank-tile grooved
Model number	38119	32059	S10002	37150	37155
Nom. dim. - cm/in	25 x 12.5 / 10 x 5	25 x 25 / 10 x 10	25 x 12.5 / 10 x 5	25 x 12.5 / 10 x 5	12.5 x 12.5 / 5 x 5
Work size mm	244 x 119 x 8	244 x 244 x 8	244 x 119 x 8	244 x 119/19 x 8	119 x 119/19 x 8
m - pieces			4.000	4.000	8.000
Pieces - kg	0.490	1.060	0.490	2.000	2.000
Bundle - pieces				20	40
Bundle - m				5.000	5.000
Bundle - kg				10.000	10.000
Product standard	Alb	Alb	Alb	Alb	Alb
Slip resistance			-/B	-/C	-/C
700 n10/white gl.	900659-38119	900659-32059			
552001 active azure	Price gr. A587 (pce.)	Price gr. A601 (pce.)			
701 n10/white matt	900672-38119	900672-32059			
552001 active azure	Price gr. A587 (pce.)	Price gr. A601 (pce.)			
700 n10/white gl.	900673-38119	900673-32059			
5716 n1/black	Price gr. A587 (pce.)	Price gr. A601 (pce.)			
701 n10/white matt	900644-38119	900644-32059			
5716 n1/black	Price gr. A587 (pce.)	Price gr. A601 (pce.)			
91 n10/white			900567-S10002		
553001 active azure			Price gr. A649 (pce.)		
91 n10/white			900044-S10002		
340 n1/black			Price gr. A649 (pce.)		
grey-beige				900-37150	900-37155
				Price gr. A434 (pce.)	Price gr. A419 (pce.)
				91-37150 ☒	91-37155 ☒
				Price gr. A438 (pce.)	Price gr. A428 (pce.)



No pallet rebate is granted for the products shown on this page.

All products: Color Shade Variation V0



The products shown on this page can also be produced in other colors of the series Chroma and Chroma non-slip. We will be pleased to check the possibility of such a special production upon request.

Shank-Tiles (as support for cover gratings)¹

25 x 12.5 cm

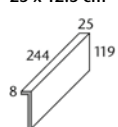

12.5 x 12.5 cm



25 x 12.5 cm

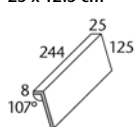

12.5 x 12.5 cm



25 x 3.3 cm

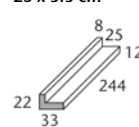

12.5 x 3.3 cm



Shank-tile	„Half-size“ shank-tile	inclined shank-tile	„Hal size“ inclined shank-tile	Supporting angle for grating	„Half-size“ supporting angle for grating	
37011	37015	37017	37018	37031	37035	Model number
25 x 12.5 / 10 x 5	12.5 x 12.5 / 5 x 5	25 x 12.5 / 10 x 5	12.5 x 12.5 / 5 x 5	25 x 3.3 / 10 x 1 3/8	12.5 x 3.3 / 5 x 1 3/8	Nom. dim. - cm/in
244 x 119/25 x 8	119 x 119/25 x 8	244 x 125/25 x 8	119 x 125/25 x 8	244 x 33/22 x 8	119 x 33/22 x 8	Work size mm
4.000	8.000	4.000	8.000	4.000	8.000	m - pieces
0.600	0.290	0.620	0.300	0.200	0.100	Pieces - kg
16	32	16	32	72	144	Bundle - pieces
4.000	4.000	4.000	4.000	18.000	18.000	Bundle - m
9.600	9.280	9.920	9.600	14.400	14.400	Bundle - kg
						Pallet - m
						Pallet - kg
Alb	Alb	Alb	Alb	Alb	Alb	Product standard
700-37011	700-37015	700-37017	700-37018	700-37031	700-37035	neutral 10
Price gr. A445 (pce.)	Price gr. A423 (pce.)	Price gr. A452 (pce.)	Price gr. A425 (pce.)	Price gr. A445 (pce.)	Price gr. A425 (pce.)	(active white glossy)
701-37011	701-37015	701-37017	701-37018	701-37031	701-37035	neutral 10
Price gr. A445 (pce.)	Price gr. A423 (pce.)	Price gr. A452 (pce.)	Price gr. A425 (pce.)	Price gr. A445 (pce.)	Price gr. A425 (pce.)	(active white matt)

¹ For cover gratings, refer to page 454



Coved Gutter Tiles

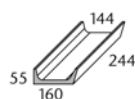

Coved gutter tile inside width 144 mm



„Half-size“ coved gutter tile

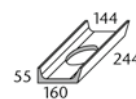

Coved gutter tile with outlet (ø 100 mm)²



Art. no. 59680

				59680	59685	59681	Model number
				244 x 160 x 55/15	119 x 160 x 55/15	244 x 160 x 55/15	Nom. dim. - cm/in
				4.000	8.000		Work size mm
				1.700	0.850	1.550	m - pieces
				4	8	4	Pieces - kg
				1.000	1.000		Bundle - pieces
				6.800	6.800	6.200	Bundle - m
							Bundle - kg
							Pallet - m
							Pallet - kg
				Alb	Alb	Alb	Product standard
				700-59680	700-59685	700-59681	neutral 10
				Price gr. A489 (pce.)	Price gr. A449 (pce.)	Price gr. A560 (pce.)	(active white glossy)
				701-59680	701-59685	701-59681	neutral 10
				Price gr. A489 (pce.)	Price gr. A449 (pce.)	Price gr. A560 (pce.)	(active white matt)



The products shown on this page can also be produced in other colors of the series Chroma and Chroma non-slip. We will be pleased to check the possibility of such a special production upon request.

² For the matching outlet valve "Silent W 2000", refer to page 456
No pallet rebate is granted for the products shown on this page.



All products: Color Shade Variation V0

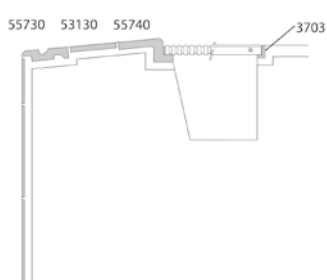
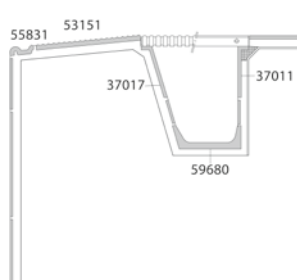
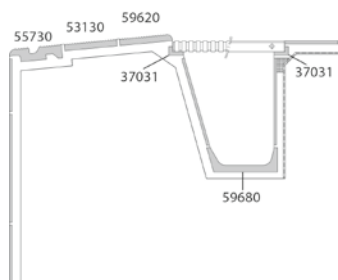

Gutter Tiles^{1/2} (trough depth 5 mm)

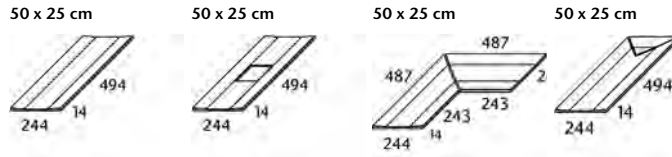

Art. no. 53320	Gutter tile	Gutter tile with Outlet 110 / 110 mm	Mitred pair	Terminal piece			
Model number	53320	53321	53322	53323			
Nom. dim. - cm/in	50 x 25 / 20 x 10	50 x 25 / 20 x 10	50 x 25 / 20 x 10	50 x 25 / 20 x 10			
Work size mm	494 x 244 x 14	494 x 244 x 14	(2x) 487 x 244 x 14	494 x 244 x 14			
m - pieces	2.000						
Pce./pair - kg	2.500/piece	2.300/piece	3.800/pair	2.500/piece			
Bundle - pce./pair	5 pieces	5 pieces	2 pairs	5 pieces			
Bundle - m	2.500						
Bundle - kg	12.500	11.500	7.600	12.500			
Product standard	Alb	Alb	Alb	Alb			
Slip resistance	see below	see below	see below	see below			
	-/B	-/B	-/B	-/B			
neutral 10 (white) ^{3/7}	91-53320 Price gr. A514 (pce.)	91-53321 Price gr. A587 (pce.)	91-53322 Price gr. A638 (pair)	91-53323 Price gr. A587 (pce.)			
	-/B	-/B	-/B	-/B			
light azure ^{3/7}	553002-53320 Price gr. A519 (pce.)	553002-53321 Price gr. A593 (pce.)	553002-53322 Price gr. A645 (pair)	553002-53323 Price gr. A593 (pce.)			
Area Pro anthracite ⁶ NEW	R11/B 435637H ^{4/5} Price gr. A519 (pce.)	R11/B 435649H ^{4/5} Price gr. A593 (pce.)	R11/B 435661H ^{4/5} Price gr. A645 (pair)	R11/B 435673H ^{4/5} Price gr. A593 (pair)			
Area Pro basalt ⁶ NEW	R11/B 435638H ^{4/5} Price gr. A519 (pce.)	R11/B 435650H ^{4/5} Price gr. A593 (pce.)	R11/B 435662H ^{4/5} Price gr. A645 (pair)	R11/B 435674H ^{4/5} Price gr. A593 (pair)			
Area Pro pebble ⁶ NEW	R11/B 435639H ^{4/5} Price gr. A519 (pce.)	R11/B 435651H ^{4/5} Price gr. A593 (pce.)	R11/B 435663H ^{4/5} Price gr. A645 (pair)	R11/B 435675H ^{4/5} Price gr. A593 (pair)			
Area Pro stein ⁶ NEW	R11/B 435640H ^{4/5} Price gr. A519 (pce.)	R11/B 435652H ^{4/5} Price gr. A593 (pce.)	R11/B 435664H ^{4/5} Price gr. A645 (pair)	R11/B 435676H ^{4/5} Price gr. A593 (pair)			
Area Pro sand-white ⁶ NEW	R11/B 435641H ^{4/5} Price gr. A519 (pce.)	R11/B 435653H ^{4/5} Price gr. A593 (pce.)	R11/B 435665H ^{4/5} Price gr. A645 (pair)	R11/B 435677H ^{4/5} Price gr. A593 (pair)			
Area Pro sand-grey ⁶ NEW	R11/B 435642H ^{4/5} Price gr. A519 (pce.)	R11/B 435654H ^{4/5} Price gr. A593 (pce.)	R11/B 435666H ^{4/5} Price gr. A645 (pair)	R11/B 435678H ^{4/5} Price gr. A593 (pair)			
Area Pro sand ⁶ NEW	R11/B 435643H ^{4/5} Price gr. A519 (pce.)	R11/B 435655H ^{4/5} Price gr. A593 (pce.)	R11/B 435667H ^{4/5} Price gr. A645 (pair)	R11/B 435679H ^{4/5} Price gr. A593 (pair)			
Area Pro nutmeg ⁶ NEW	R11/B 435644H ^{4/5} Price gr. A519 (pce.)	R11/B 435656H ^{4/5} Price gr. A593 (pce.)	R11/B 435668H ^{4/5} Price gr. A645 (pair)	R11/B 435680H ^{4/5} Price gr. A593 (pair)			
Area Pro platinum ⁶ NEW	R11/B 435645H ^{4/5} Price gr. A519 (pce.)	R11/B 435657H ^{4/5} Price gr. A593 (pce.)	R11/B 435669H ^{4/5} Price gr. A645 (pair)	R11/B 435681H ^{4/5} Price gr. A593 (pair)			
Area Pro sand-beige ⁶ NEW	R11/B 435646H ^{4/5} Price gr. A519 (pce.)	R11/B 435658H ^{4/5} Price gr. A593 (pce.)	R11/B 435670H ^{4/5} Price gr. A645 (pair)	R11/B 435682H ^{4/5} Price gr. A593 (pair)			
Area Pro brick ⁶ NEW	R11/B 435647H ^{4/5} Price gr. A519 (pce.)	R11/B 435659H ^{4/5} Price gr. A593 (pce.)	R11/B 435671H ^{4/5} Price gr. A645 (pair)	R11/B 435683H ^{4/5} Price gr. A593 (pair)			
Area Pro clay ⁶ NEW	R11/B 435648H ^{4/5} Price gr. A519 (pce.)	R11/B 435660H ^{4/5} Price gr. A593 (pce.)	R11/B 435672H ^{4/5} Price gr. A645 (pair)	R11/B 435684H ^{4/5} Price gr. A593 (pair)			



¹ Short edge rectified

² Also available in a length of 497 mm on request.

³ Also available as special production in the series Chroma non-slip or Chroma unglazed - Quantum.

⁴ These articles comply with DIN EN 14411, group Al_b, unglazed (UGL).

⁵ Make-to-order production: return and/or cancellation of ordered products not possible.

⁶ All products of the series Area Pro: Color Shade Variation V2.

⁷ All products of the series Chroma: Color Shade Variation V0.

Gutter Tiles^{1/2} (trough depth 5 mm)

50 x 25 cm

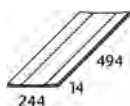

50 x 25 cm

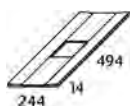

50 x 25 cm

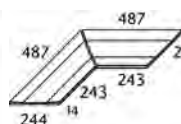

50 x 25 cm

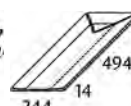

			Gutter tile	Gutter tile with Outlet 110 / 110 mm	Mitred pair	Terminal piece	Art. no. 53320
			53320	53321	53322	53323	Model number
			50 x 25 / 20 x 10	50 x 25 / 20 x 10	50 x 25 / 20 x 10	50 x 25 / 20 x 10	Nom. dim. - cm/in
			494 x 244 x 14	494 x 244 x 14	(2x) 487 x 244 x 14	494 x 244 x 14	Work size mm
			2.000				m - pieces
			2.500/piece	2.300/piece	3.800/pair	2.500/piece	Pce./pair - kg
			5 pieces	5 pieces	2 pairs	5 pieces	Bundle - pce./pair
			2.500				Bundle - m
			12.500	11.500	7.600	12.500	Bundle - kg
							Pallet - m
							Pallet - kg
			Alb	Alb	Alb	Alb	Product standard
			R11/B	R11/B	R11/B	R11/B	Slip resistance
			430810H	430814H	430818H	430822H	Ascona ³
			Price gr. A519 (pce.)	Price gr. A593 (pce.)	Price gr. A645 (pair)	Price gr. A593 (pce.)	pearl
			430811H	430815H	430819H	430823H	Ascona ³
			Price gr. A519 (pce.)	Price gr. A593 (pce.)	Price gr. A645 (pair)	Price gr. A593 (pce.)	mud
			430812H	430816H	430820H	430824H	Ascona ³
			Price gr. A519 (pce.)	Price gr. A593 (pce.)	Price gr. A645 (pair)	Price gr. A593 (pce.)	stone
			430813H	430817H	430821H	430825H	Ascona ³
			Price gr. A519 (pce.)	Price gr. A593 (pce.)	Price gr. A645 (pair)	Price gr. A593 (pce.)	graphite
			431559H	431561H	431563H	431565H	Ascona ³
			Price gr. A519 (pce.)	Price gr. A593 (pce.)	Price gr. A645 (pair)	Price gr. A593 (pce.)	shell
			431560H	431562H	431564H	431566H	Ascona ³ NEW
			Price gr. A519 (pce.)	Price gr. A593 (pce.)	Price gr. A645 (pce.)	Price gr. A593 (pce.)	sand NEW
			8460-53320	8460-53321	8460-53322	8460-53323	Quarzit ⁴
			Price gr. A519 (pce.)	Price gr. A593 (pce.)	Price gr. A645 (pair)	Price gr. A593 (pce.)	basalt-grey
			8461-53320	8461-53321	8461-53322	8461-53323	Quarzit ⁴
			Price gr. A519 (pce.)	Price gr. A593 (pce.)	Price gr. A645 (pair)	Price gr. A593 (pce.)	quartz-grey
			8462-53320	8462-53321	8462-53322	8462-53323	Quarzit ⁴
			Price gr. A519 (pce.)	Price gr. A593 (pce.)	Price gr. A645 (pair)	Price gr. A593 (pce.)	sand-beige
			8463-53320	8463-53321	8463-53322	8463-53323	Quarzit ⁴
			Price gr. A519 (pce.)	Price gr. A593 (pce.)	Price gr. A645 (pair)	Price gr. A593 (pce.)	sepia-brown
			8464-53320	8464-53321	8464-53322	8464-53323	Quarzit ⁴
			Price gr. A519 (pce.)	Price gr. A593 (pce.)	Price gr. A645 (pair)	Price gr. A593 (pce.)	white-grey

¹ Short edge rectified



² Can also be produced in a length of 497 mm on request.

³ All products of the series Ascona: Color Shade Variation V3

⁴ All products of the series Quarzit: Color Shade Variation V4

Gutter Tiles (trough depth 15 mm)

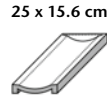
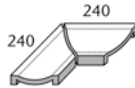
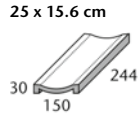

Art. no. 54420

Gutter tile

Gutter tile with outlet 1 1/2"

Mitred pair

Terminal piece

Model number	54420	54421	54422	54423			
Nom. dim. - cm/in	25 x 15.6 / 10 x 6 1/4	25 x 15.6 / 10 x 6 1/4		25 x 15.6 / 10 x 6 1/4			
Work size mm	244 x 150 x 30	244 x 150 x 30	(2x) 240 x 150 x 30	244 x 150 x 30			
m - pieces	4.000						
Pce./pair - kg	1.800/piece	1.530/piece	3.030/pair	1.950/piece			
Bundle - pce./pair	8 pieces	8 pieces	4 pairs	8 pieces			
Bundle - m	2.000						
Bundle - kg	14.400	12.240	12.120	15.600			
Pallet - m							
Pallet - kg							
Product standard	Alb	Alb	Alb	Alb			
Slip resistance	see below	see below	see below	see below			
	R10/A	R10/A	R10/A	R10/A			
grey-beige	900-54420 Price gr. A458 (pce.)	900-54421 Price gr. A560 (pce.)	900-54422 Price gr. A581 (pair)	900-54423 Price gr. A560 (pce.)			
	R11/B	R11/B	R11/B	R11/B			
grey-white	902R-54420 Price gr. A458 (pce.)	902R-54421 Price gr. A560 (pce.)	902R-54422 Price gr. A581 (pair)	902R-54423 Price gr. A560 (pce.)			
	-/B	-/B	-/B	-/B			
neutral 10 (white)	91-54420 Price gr. A475 (pce.)	91-54421 Price gr. A577 (pce.)	91-54422 Price gr. A601 (pair)	91-54423 Price gr. A577 (pce.)			



fitting insert for the outlet:
Article no. 182,
see page 444
(installation prior to laying).

The products shown on this page can also be produced in other colors of the series Chroma and Chroma non-slip. We will be pleased to check the possibility of such a special production upon request.

No pallet rebate is granted for the products shown on this page.

All products: Color Shade Variation V0

Project: Bybadet / Location: Alesund, Norway / Architect: Invit Arkitekter AS, Alesund, Norway / Photo: Tove Lauluten, Oslo



Series: Pool edge system Wiesbaden Silent





450 CERAMIC CHANNEL COVER 2.0

3D Rendering / Series: Area Pro





Ceramic channel cover for private and hotel pools

Exclusive design options are opened up by the pool edge system "Wiesbaden Stil": by using the ceramic channel cover, the entire pool surround inclusive of the pool edge can be designed in a uniform look. The colors and the special surfaces of the tile series Quarzit, Valley and Emotion are available. The supports and base plates of the channel cover are also supplied in matching colors. The cover is slip-resistant and very robust. Plug-in connections ensure quick and easy laying. On request, different formats and free forms are also available. Water flow rate: free cross-section 245 cm²/m in case of the standard hole pattern.

452 CERAMIC CHANNEL COVER 2.0

Cross-section

Cover tile 8 mm
(Quarzit)

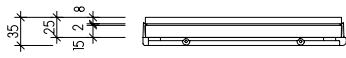

Cross-section

Cover tile 10,5 mm (Emotion)
Cover tile 10 mm (Valley)

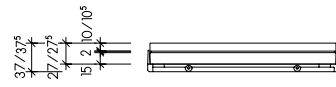

External corner

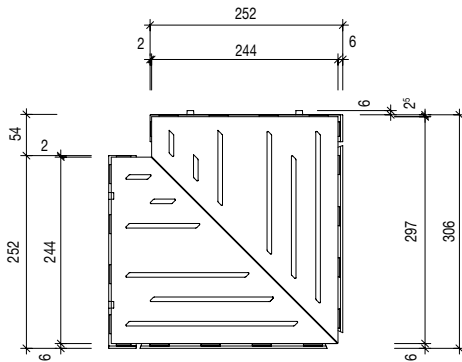

Internal corner

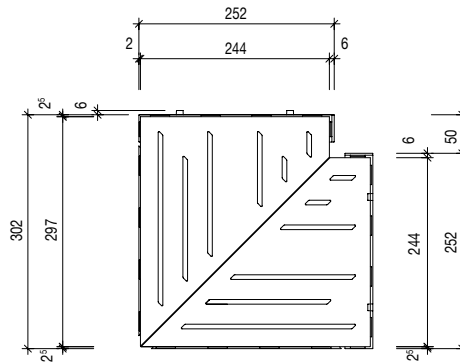

Ceramic cover grating

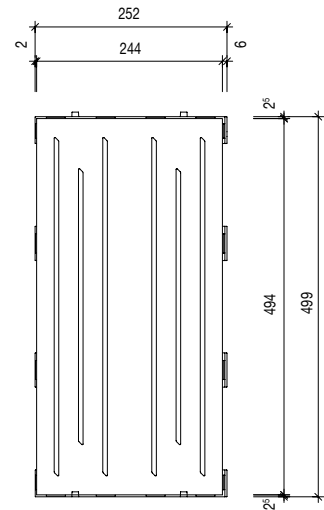





Available surfaces:

Area Pro, Ascona, Emotion, Quarzit, Valley

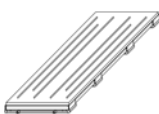

3D Rendering / Series: Area Pro

Only applies to the ceramic covering material:
 Extruded Ceramic Tiles, Precision, DIN EN 14411,
 group Al_b, unglazed (UGL) for floor and wall coverings in
 indoor and outdoor areas (porcelain stoneware tiles) //
 Dry-pressed Ceramic Tiles, DIN EN 14411, group Bl_a, unglazed (UGL)
 for floor and wall coverings in indoor and outdoor areas (porcelain stoneware tiles)

				External Angle		Internal Angle			
				25 x 50 cm	30 x 30 cm	30 x 30 cm			
									
				<i>Design Quarzit</i>	<i>Design Quarzit</i>	<i>Design Quarzit</i>			
				53510H	53512H	53511H			Model number
				25 x 50 / 10 x 20	30 x 30 / 12 x 12	30 x 30 / 12 x 12			Nom. dim. - cm/in
				253 x 500 x 35 ^{2/3}	253 x 306/306 x 35 ^{2/4}	253 x 302/302 x 35 ^{2/4}			Work size mm
				2					m - pieces
				12.212/m	4.312/piece	4.312/piece			m/St. - kg
				1	1	1			Bundle - pieces
				0.500					Bundle - m
				6.106	4.312	4.312			Bundle - kg
									Pallet - m
									Pallet - kg
				Alb	Alb	Alb			Product standard
				R11/B	R11/B	R11/B			Slip resistance
				8462-53510H ¹	8462-53512H ¹	8462-53511H ¹			
				Price gr. A731 (pce.)	Price gr. A781 (pce.)	Price gr. A781 (pce.)			sand-beige

¹  Make-to-order production, period of delivery on request.
 Other colors / designs can be realized on request.





² Element size in built-in state incl. joint
³ complete element incl. plugs: 253 x 506 x 35 mm
⁴ complete element incl. plugs: 253 x 312/309 x 35 mm

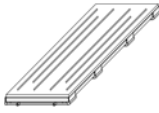

Note: according to DIN 19643-1, the volume flow rates in relation to the free cross-section of the ceramic channel cover must be proved.

All products of the series Quarzit: Color Shade Variation V4

Free cross-section: approx. 245 cm²/m

				External Corner		Internal Corner			
				25 x 50 cm	30 x 30 cm	30 x 30 cm			
									
				<i>Design Valley structured, upgraded</i>	<i>Design Valley structured, upgraded</i>	<i>Design Valley structured, upgraded</i>			protected
				53510	53512	53511			Model number
				25 x 50 / 10 x 20	30 x 30 / 12 x 12	30 x 30 / 12 x 12			Nom. dim. - cm/in
				253 x 500 x 37 ^{2/3}	253 x 306/306 x 37 ^{2/4}	253 x 302/302 x 37 ^{2/4}			Work size mm
				2					m - pieces
				13.274/m	4.687/piece	4.687/piece			m/St. - kg
				1	1	1			Bundle - pieces
				0.500					Bundle - m
				6.637	4.687	4.687			Bundle - kg
									Pallet - m
									Pallet - kg
				Bla	Bla	Bla			Product standard
				R11/B	R11/B	R11/B			Slip resistance
				052036-53510 ¹	052036-53512 ¹	052036-53511 ¹			
				Price gr. A731 (pce.)	Price gr. A781 (pce.)	Price gr. A781 (pce.)			slate

¹  Make-to-order production, period of delivery on request.
 Other colors / designs can be realized on request.

² Element size in built-in state incl. joint
³ complete element incl. plugs: 253 x 506 x 37 mm
⁴ complete element incl. plugs: 253 x 312/309 x 37 mm



Note: according to DIN 19643-1, the volume flow rates in relation to the free cross-section of the ceramic channel cover must be proved.

All products of the series Valley: Color Shade Variation V2

Free cross-section: approx. 245 cm²/m

Top-quality cover gratings

Even with regard to details which are often hardly noticed, high quality pays off: cover gratings from Agrob Buchtal, available as transverse or parallel gratings, are made of high-quality, high impact strength plastics with UV absorber, connection of the individual slats by means of tear-resistant PUR round cord and intermediate rolls in a color matching the individual slats. The gratings are designed for the loads to be expected by being walked on barefoot. It is almost impossible to break individual rods.



Transverse gratings

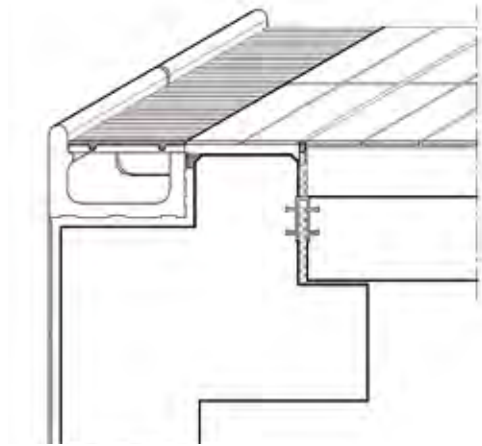

Parallel gratings

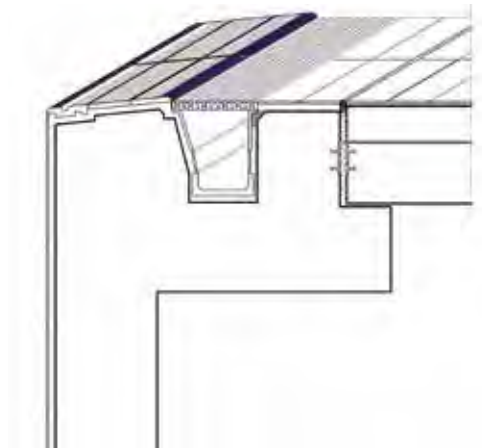

Transverse gratings, flexible¹

Grating thickness	25 mm	25 mm
Grating width	191 mm	250 mm
Article no.	R10000	R10100
Transverse grating, flexible	Price gr. A722 (lin. m.)	Price gr. A731 (lin. m.)

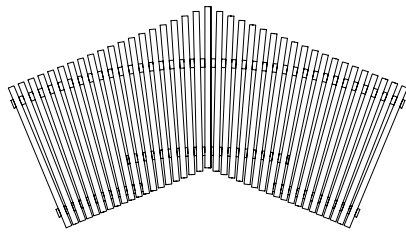

Fan-shaped corner, art. no.: R12100
Transverse grating, 250 mm wide

Transverse gratings, rigid, for the low-noise channel³

Grating thickness	25 mm	25 mm
Grating width	191 mm	250 mm
Article-No.	R20000	R20100
Transverse grating	Price gr. A731 (lin. m.)	Price gr. A757 (lin. m.)
Article-No.	R21000	R21100
Mitred corners 1E+AE+Special ²	Price gr. A750 (pce.)	Price gr. A766 (pce.)

¹ Also available as fan-shaped corner and curved grating. Prices on request.

² All corner elements are rigid.

³ Also available as curved grating. Price on request.

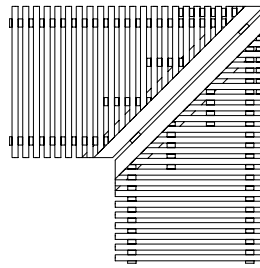

Mitred corner, art. no.: R21100
Transverse grating, 250 mm wide

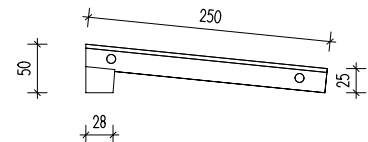

Art. no.: R40100
Inclined transverse grating,
250 mm wide

Parallel gratings, rigid⁴

Grating thickness	25 mm
Grating width	250 mm
Article-No.	R50100
Parallel grating	Price gr. A748 (lin. m.)
Article-No.	R51100
Mitred corners 1E+AE+Special ³	Price gr. A791 (pce.)

³ All corner elements are rigid.

⁴ Not available as curved gratings for technical reasons.

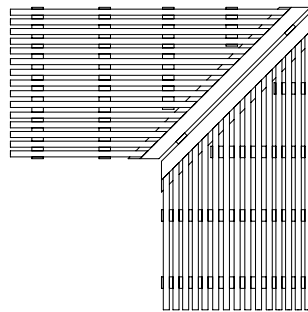

Mitred corner, art. no.: R51100
Parallel grating, 250 mm wide

Survey of colors:

Distinction by the last figure of the article number

Last figure 0 = Standard colors (grey = RAL7001 / white = RAL9010 / beige = RAL1001 / yellow = RAL1018)

Last figure 1 = Semi-colors (light ivory = RAL1015 / traffic blue = RAL5017 / traffic red = RAL3020 / deep black = RAL9005)

Last figure 2 = Special colors according to RAL (except Metallic shades)

Outlet valve Silent W 2000 (patented)

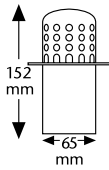

Outlet valve Silent 100 (patented) With optimized connecting system

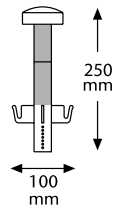

Outlet (brass with sieve of V4A)

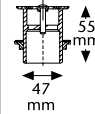

Draining volume max. 2,4 m³/h (installation with gutter tile)

The water drainage takes place almost silently at a considerably increased flow rate. Silent W 2000 and Silent 100 consist of high-quality material (PVC-free) which is equally resistant to water treated with chlorine, salt, ozone, thermal and mineral water as to the cleaning agents normally used in swimming pools.

Ø 75 mm	Ø 86 mm	Ø 100 mm	1 1/2 inches	Fits openings with
Fits overflow channel 55141, 86161	Fits overflow channels 55101, 85161, 55181, 85191, 95161, 87161, 85181	Fits covered gutter tile 59681	Fits covered gutter tile 54421	
178 Price gr. A723 (pce.)	179 Price gr. A723 (pce.)	177 Price gr. A723 (pce.)	182 Price gr. A668 (pce.)	Article-No.
178-S (black) Price gr. A731 (pce.)	179-S (black) Price gr. A731 (pce.)			Article-No.

Note: Rebate for accessories is separately regulated!

No pallet rebate is granted for the products shown on this page.

Project: Paracelsus Bad & Kurhaus / Location: Salzburg, Austria / Architect: Berger + Parkkinen / Series: Pool edge system Wiesbaden, Savona / Photo: Christian Richters

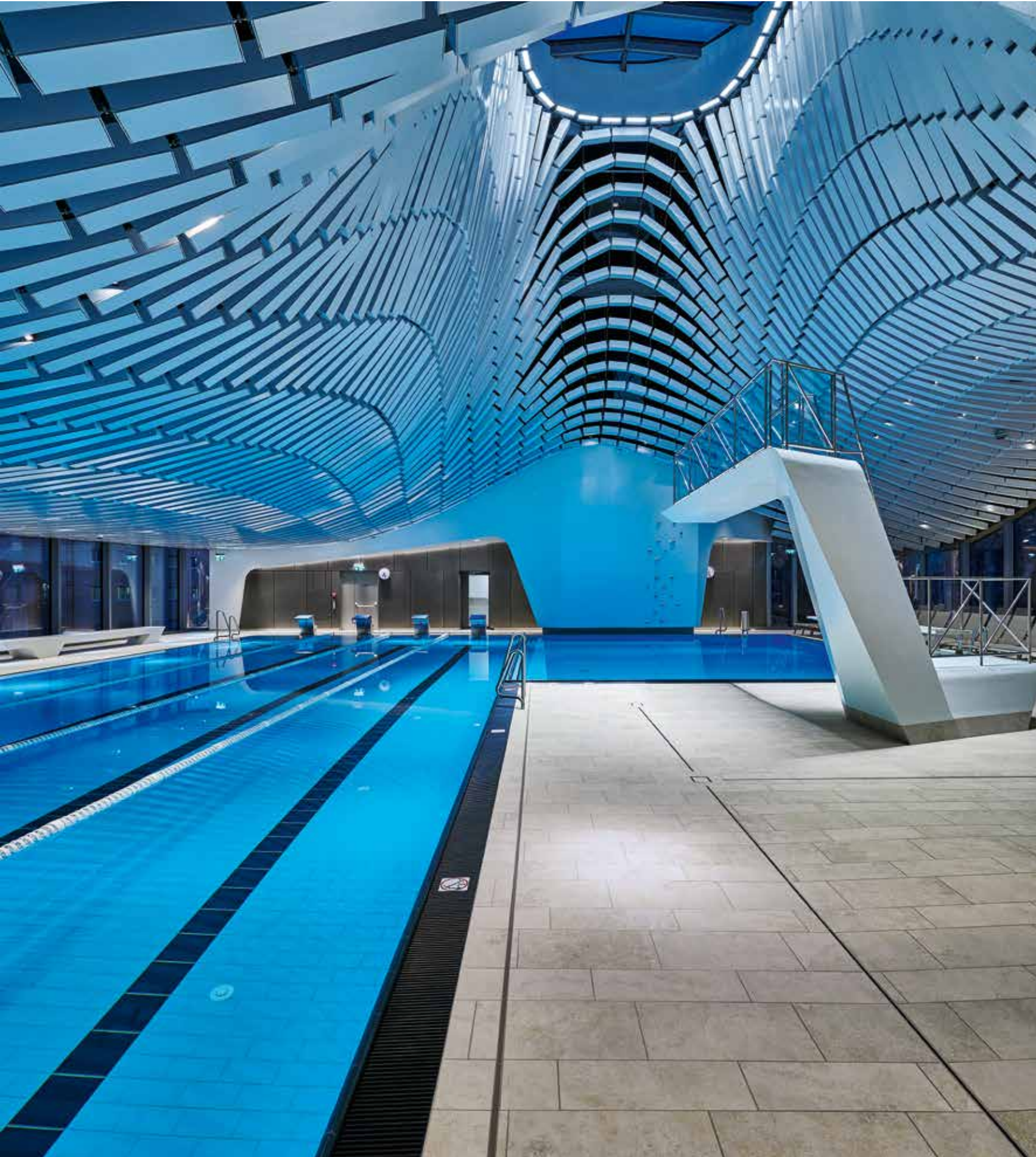



Living

residential ceramics







Warm und natürlich

Für Wand und Boden in Wohn- und Nassbereichen bietet Alcina mit ihren natürlich strukturierten Oberflächen eine elegante Palette an erdigen und warmen Tönen. So lässt sich Alcina mit verschiedenen Wohnstilen kombinieren. Die zart eingefärbten Wandfliesen verfügen über eine Hytect-Oberfläche. Starke oder dezente Kontraste dazu bilden Bodenfliesen in unterschiedlichen Farben und Formaten. Für stilvolle Abwechslung sorgt das Schnittdekor Sola – in allen Bodenfarben. Passende Sockel sowie ein trittsicheres 5 x 5-Mosaik runden das breite Fliesenprogramm ab.

Chaleureux et naturel

Pour les murs et les sols des espaces d'habitat et des zones humides, Alcina offre une palette élégante de tons terreux et chaleureux grâce à ses surfaces naturellement structurées. De cette façon, Alcina peut être combinée avec différents styles de vie. Les carreaux de mur aux couleurs délicates ont une surface Hytect. Des contrastes forts ou subtils sont fournis par des carreaux de sol de couleurs et de formats différents. Le décor coupé Sola – dans toutes les couleurs de sol – assure le changement stylistique. Des plinthes assorties et une mosaïque 5 x 5 antidérapante complètent cette large gamme de carreaux.

Warm and natural

With its naturally textured surfaces, Alcina offers an elegant range of earthy and warm shades for walls and floors in living and wet areas. Accordingly, Alcina can be combined with various living styles. The delicately coloured wall tiles have a Hytect surface. Strong or subtle contrasts are created by floor tiles in different colours and formats. The Sola décor provides stylish variety – in all floor colours. This extensive range of tiles is rounded off by matching skirtings and non-slip 5 x 5 cm mosaics.



Art.	Nennmaß cote nominale nominal size cm	Herstellmaß cote de fabrication production size mm	m ²	Paket carton box	Palette palette pallet	Beanspr.-Gruppe groupe d'emploi wear resist. group	Norm Norme Standard	Trittsicherheit antidérapance non-slip	Preisgruppe groupe de prix price category
203435H	30 x 60	297 x 597 x 6	5,556 St pc	13 St pc	112,311 m ²		BIII GL		C77 (m ²)
203436H			10,279 kg	2,340 m ² 24,050 kg	1.154,400 kg		BIII GL		C77 (m ²)
323437H	30 x 90	297 x 897 x 6	3,704 St pc	8 St pc	51,836 m ²		BIII GL		C155 (m ²)
323438H			10,400 kg	2,160 m ² 22,464 kg	539,136 kg		BIII GL		C155 (m ²)

Wandfliese | carreau de mur | wall tile
Steingut glasiert | faïence émaillée | earthenware glazed

30 x 60 cm

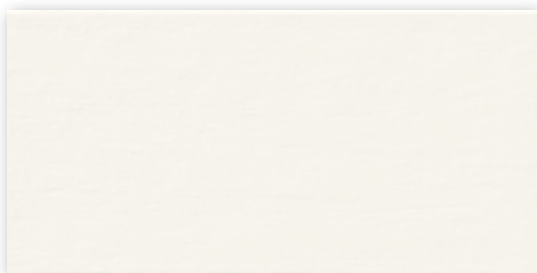

203435H
weiß | blanc | white
strukturiert, seidenmatt | structuré, satiné | structured, silky-matt

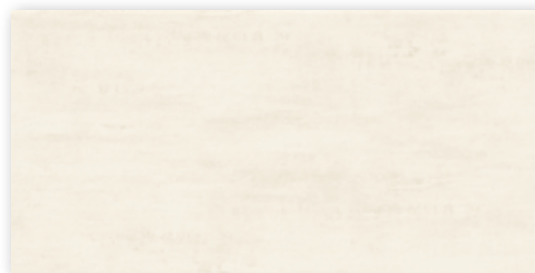

203436H
beige
strukturiert, seidenmatt | structuré, satiné | structured, silky-matt

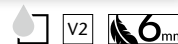

30 x 90 cm

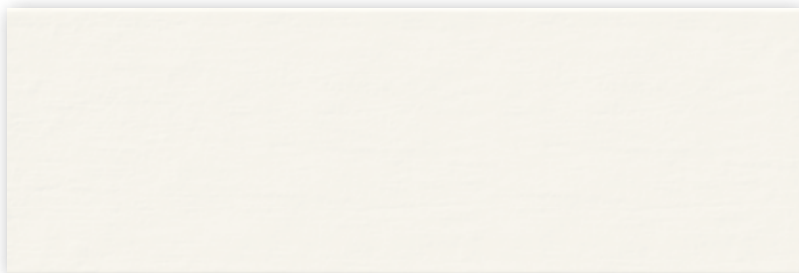

323437H
weiß | blanc | white
strukturiert, seidenmatt | structuré, satiné | structured, silky-matt

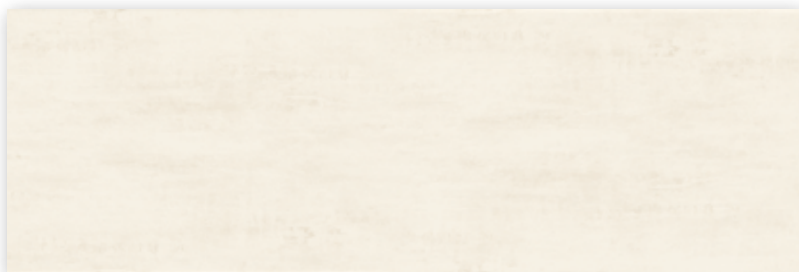
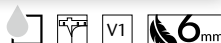

323438H
beige
strukturiert, seidenmatt | structuré, satiné | structured, silky-matt



Art.	Nennmaß cote nominale nominal size cm	Herstellmaß cote de fabrication production size mm	m	Paket carton box	Palette palette pallet	Beanspr.-Gruppe groupe d'emploi wear resist. group	Norm Norme Standard	Trittsicherheit antidérapance non-slip	Preisgruppe groupe de prix price category
203439							Bla UGL		C510 (St pc)
203440							Bla UGL		C510 (St pc)
203441	24,3 x 43,8	240 x 435 x 6	2,639 St pc	3 St pc			Bla UGL		C510 (St pc)
203442			3,077 kg	1,137 m	3,498 kg		Bla UGL		C510 (St pc)
203443							Bla UGL		C510 (St pc)

Dekorationselemente | éléments décoratifs | decoration elements

Bordüre Sola | bordure Sola | border Sola

Feinsteinzeugfliesen unglasiert | grès cérame fin vitrifié non-émaillés | porcelain stoneware tiles unglazed

24,3 x 43,8 cm

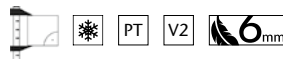

203439

crema
strukturiert, matt | structuré, mat | structured, matt

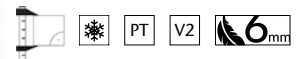

203440

lehm Braun | brun argile | clay-brown
strukturiert, matt | structuré, mat | structured, matt

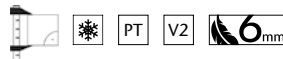

203441

kieselgrau | gris galet | pebble-grey
strukturiert, matt | structuré, mat | structured, matt

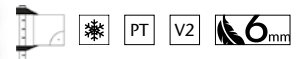
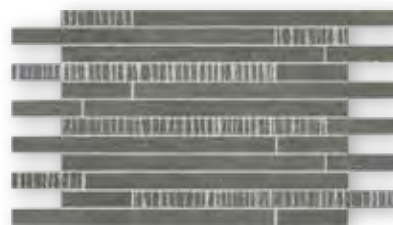

203442

basalt | basalte | basalt
strukturiert, matt | structuré, mat | structured, matt

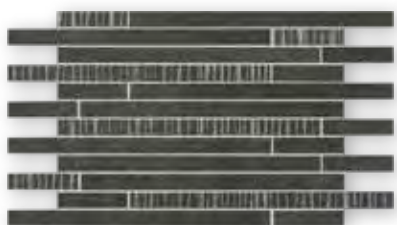

203443

graphit | graphite
strukturiert, matt | structuré, mat | structured, matt

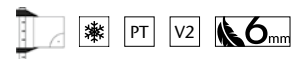
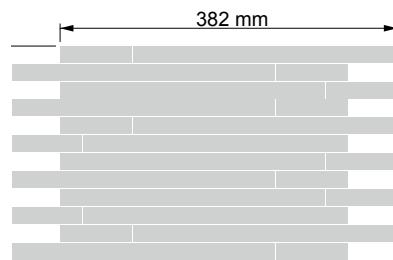

Abgabe der Dekorationselemente ausschließlich in vollen Kartons.
Éléments décoratifs uniquement livrables en cartons entiers.
Decoration elements only available in full boxes.

Bordüre, Verklebung rückseitig auf Glasfasernetz,
Bogen: 240 x 435 mm
Bordure, collée sur trame en fibre de verre à
l'envers, Feuille : 240 x 435 mm
Border, glass fibre net on reverse side,
Sheet: 240 x 435 mm

Art.	Nennmaß cote nominale nominal size cm	Herstellmaß cote de fabrication production size mm	m ²	Paket carton box	Palette palette pallet	Beanspr.-Gruppe groupe d'emploi wear resist. group	Norm Norme Standard	Trittsicherheit antidérapance non-slip	Preisgruppe groupe de prix price category
431485							Bla UGL	R10/A+B	C107 (m ²)
431486							Bla UGL	R10/A+B	C107 (m ²)
431487	30 x 60	297 x 597 x 6	5,556 St pc 13,273 kg	10 St pc	71,994 m ²		Bla UGL	R10/A+B	C107 (m ²)
431488				1,800 m ² 23,890 kg	955,600 kg		Bla UGL	R10/A+B	C107 (m ²)
431489							Bla UGL	R10/A+B	C107 (m ²)
434816							Bla UGL	R9	C134 (m ²)
434817	30 x 60	297 x 597 x 10,5	5,556 St pc 23,224 kg	6 St pc	43,197 m ²		Bla UGL	R9	C134 (m ²)
434818				1,080 m ² 25,080 kg	1.003,200 kg		Bla UGL	R9	C134 (m ²)
434819							Bla UGL	R9	C134 (m ²)
434820							Bla UGL	R9	C134 (m ²)



crema



lehm Braun
brun argile
clay-brown



kieselgrau
gris galet
pebble-grey



basalt
basalte
basalt



graphit
graphite



Bodenfliese | carreau de sol | floor tile

Feinsteinzeugfliesen unglasiert | grès cérame fin vitrifié non-émaillés | porcelain stoneware tiles unglazed

30 x 60 cm



431485

crema

strukturiert, matt | structuré, mat | structured, matt



434816

crema

strukturiert, matt | structuré, mat | structured, matt



431486

lehm Braun | brun argile | clay-brown

strukturiert, matt | structuré, mat | structured, matt

434817

lehm Braun | brun argile | clay-brown

strukturiert, matt | structuré, mat | structured, matt

431487

kieselgrau | gris galet | pebble-grey

strukturiert, matt | structuré, mat | structured, matt

434818

kieselgrau | gris galet | pebble-grey

strukturiert, matt | structuré, mat | structured, matt

431488

basalt | basalte | basalt

strukturiert, matt | structuré, mat | structured, matt

434819

basalt | basalte | basalt

strukturiert, matt | structuré, mat | structured, matt

431489

graphit | graphite

strukturiert, matt | structuré, mat | structured, matt

434820

graphit | graphite

strukturiert, matt | structuré, mat | structured, matt

Art.	Nennmaß cote nominale nominal size cm	Herstellmaß cote de fabrication production size mm	m ²	Paket carton box	Palette palette pallet	Beanspr.-Gruppe groupe d'emploi wear resist. group	Norm Norme Standard	Trittsicherheit antidérapance non-slip	Preisgruppe groupe de prix price category
431490							Bla UGL	R10/A+B	C119 (m ²)
431491							Bla UGL	R10/A+B	C119 (m ²)
431492	60 x 60	597 x 597 x 6	2,778 St pc	5 St pc	64,795 m ²		Bla UGL	R10/A+B	C119 (m ²)
431493			13,581 kg	1,800 m ² 24,445 kg	880,020 kg		Bla UGL	R10/A+B	C119 (m ²)
431494							Bla UGL	R10/A+B	C119 (m ²)
434821							Bla UGL	R9	C149 (m ²)
434822							Bla UGL	R9	C149 (m ²)
434823	60 x 60	597 x 597 x 10,5	2,778 St pc	3 St pc	38,877 m ²		Bla UGL	R9	C149 (m ²)
434824			23,769 kg	1,080 m ² 25,668 kg	924,048 kg		Bla UGL	R9	C149 (m ²)
434825							Bla UGL	R9	C149 (m ²)

Bodenfliese | carreau de sol | floor tile

Feinsteinzeugfliesen unglasiert | grès cérame fin vitrifié non-émaillés | porcelain stoneware tiles unglazed

60 x 60 cm



431490

crema

strukturiert, matt | structuré, mat | structured, matt

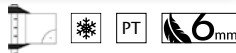

431491

lehm Braun | brun argile | clay-brown

strukturiert, matt | structuré, mat | structured, matt

431492

kieselgrau | gris galet | pebble-grey

strukturiert, matt | structuré, mat | structured, matt

431493

basalt | basalte | basalt

strukturiert, matt | structuré, mat | structured, matt

431494

graphit | graphite

strukturiert, matt | structuré, mat | structured, matt



434821

crema

strukturiert, matt | structuré, mat | structured, matt



434822

lehm Braun | brun argile | clay-brown

strukturiert, matt | structuré, mat | structured, matt

434823

kieselgrau | gris galet | pebble-grey

strukturiert, matt | structuré, mat | structured, matt

434824

basalt | basalte | basalt

strukturiert, matt | structuré, mat | structured, matt

434825

graphit | graphite

strukturiert, matt | structuré, mat | structured, matt

Art.	Nennmaß cote nominale nominal size cm	Herstellmaß cote de fabrication production size mm	m ²	Paket carton box	Palette palette pallet	Beanspr.-Gruppe groupe d'emploi wear resist. group	Norm Norme Standard	Trittsicherheit antidérapance non-slip	Preisgruppe groupe de prix price category
434831							Bla UGL	R9	C149 (m ²)
434832	45 x 90	447 x 897 x 10,5	2,470 St pc	2 St pc	32,389 m ²		Bla UGL	R9	C149 (m ²)
434833			23,070 kg	0,810 m ²	18,680 kg	747,200 kg	Bla UGL	R9	C149 (m ²)
434834							Bla UGL	R9	C149 (m ²)
434835							Bla UGL	R9	C149 (m ²)



crema

lehm Braun
brun argile
clay-brownkieselgrau
gris galet
pebble-greybasalt
basalte
basaltgraphit
graphite

Bodenfliese | carreau de sol | floor tile

Feinsteinzeugfliesen unglasiert | grès cérame fin vitrifié non-émaillés | porcelain stoneware tiles unglazed

45 x 90 cm *



434831

crema
strukturiert, matt | structuré, mat | structured, matt

434832

lehm Braun | brun argile | clay-brown
strukturiert, matt | structuré, mat | structured, matt

434833

kieselgrau | gris galet | pebble-grey
strukturiert, matt | structuré, mat | structured, matt

434834

basalt | basalte | basalt
strukturiert, matt | structuré, mat | structured, matt

434835

graphit | graphite
strukturiert, matt | structuré, mat | structured, matt

* Achtung: Sonderpalette. Keine Rücknahme, kein Umtausch.

* Attention : palette spéciale. Pas de retour, pas d'échange.

* Please note: special pallet. No return, no exchange.

Art.	Nennmaß cote nominale nominal size cm	Herstellmaß cote de fabrication production size mm	m ²	Paket carton box	Palette palette pallet	Beanspr.-Gruppe groupe d'emploi wear resist. group	Norm Norme Standard	Trittsicherheit antidérapance non-slip	Preisgruppe groupe de prix price category
434895							Bla UGL	R9	C188 (m ²)
434896	90 x 90	895 x 895 x 11,0	1,234 St pc	2 St pc	48,622 m ²		Bla UGL	R9	C188 (m ²)
434897			24,691 kg	1,621 m ² 40,018 kg	1.200,540 kg		Bla UGL	R9	C188 (m ²)

Bodenfliese | carreau de sol | floor tile

Feinsteinzeugfliesen unglasiert | grès cérame fin vitrifié non-émaillés | porcelain stoneware tiles unglazed

90 x 90 cm *



434895

kieselgrau | gris silex | pebble grey
strukturiert, matt | structuré, mat | structured, matt

434896

basalt | basalte
strukturiert, matt | structuré, mat | structured, matt

434897

graphit | graphite
strukturiert, matt | structuré, mat | structured, matt

* Achtung: Sonderpalette. Keine Rücknahme, kein Umtausch.

* Attention : palette spéciale. Pas de retour, pas d'échange.

* Please note: special pallet. No return, no exchange.

Art.	Nennmaß cote nominale nominal size cm	Herstellmaß cote de fabrication production size mm	m ²	Paket carton box	Palette palette pallet	Beanspr.-Gruppe groupe d'emploi wear resist. group	Norm Norme Standard	Trittsicherheit antidérapance non-slip	Preisgruppe groupe de prix price category
434983H							Bla UGL	R11/B	C239 (m ²)
434984H	60 x 60	597 x 597 x 20	2,778 St pc	2 St pc	21,598 m ²		Bla UGL	R11/B	C239 (m ²)
434985H			45,273 kg	0,720 m ² 32,594 kg	977,820 kg		Bla UGL	R11/B	C239 (m ²)



crema



lehm Braun
brun argile
clay-brown



kieselgrau
gris galet
pebble-grey



basalt
basalte
basalt



graphit
graphite



Terrassenplatte | dalle de terrasse | patio tile

Feinsteinzeugfliesen unglasiert | grès cérame fin vitrifié non-émaillés | porcelain stoneware tiles unglazed

60 x 60 cm*



434983H

kieselgrau | gris silex | pebble grey
strukturiert, matt | structuré, mat | structured, matt

434984H

basalt | basalte
strukturiert, matt | structuré, mat | structured, matt

434985H

graphit | graphite
strukturiert, matt | structuré, mat | structured, matt

* Hohes Gewicht! Karton bitte nur zu Zweit transportieren.
* Poids élevé ; a transporter par deux personnes seulement.
* High weight only to carry with two persons.

Art.	Nennmaß cote nominale nominal size cm	Herstellmaß cote de fabrication production size mm	m	Paket carton box	Palette palette pallet	Beanspr.-Gruppe groupe d'emploi wear resist. group	Norm Norme Standard	Trittsicherheit antidérapance non-slip	Preisgruppe groupe de prix price category
431495							Bla UGL	C440 (St pc)	
431496							Bla UGL	C440 (St pc)	
431497	7 x 60	70 x 597 x 6	1,667 St pc / m	38 St pc			Bla UGL	C440 (St pc)	
431498			0,938 kg	22,795 m	21,394 kg / m		Bla UGL	C440 (St pc)	
431499							Bla UGL	C440 (St pc)	
434826							Bla UGL	C440 (St pc)	
434827							Bla UGL	C440 (St pc)	
434828	7 x 60	70 x 597 x 10,5	1,667 St pc / m	15 St pc			Bla UGL	C440 (St pc)	
434829			1,584 kg	8,998 m	14,250 kg / m		Bla UGL	C440 (St pc)	
434830							Bla UGL	C440 (St pc)	

Sockel, gerundet | plinthe, arrondie | skirting, rounded

Feinsteinzeugfliesen unglasiert | grès cérame fin vitrifié non-émaillés | porcelain stoneware tiles unglazed

7 x 60 cm

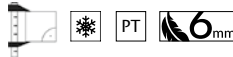

431495

crema
strukturiert, matt | structuré, mat |
structured, matt

431497

kieselgrau | gris galet | pebble-grey
strukturiert, matt | structuré, mat |
structured, matt

431499

graphit | graphite
strukturiert, matt | structuré, mat |
structured, matt

431496

lehmbraun | brun argile | clay-brown
strukturiert, matt | structuré, mat |
structured, matt

431498

basalt | basalte | basalt
strukturiert, matt | structuré, mat |
structured, matt

7 x 60 cm



434826

crema
strukturiert, matt | structuré, mat |
structured, matt

434828

kieselgrau | gris galet | pebble-grey
strukturiert, matt | structuré, mat |
structured, matt

434830

graphit | graphite
strukturiert, matt | structuré, mat |
structured, matt

434827

lehmbraun | brun argile | clay-brown
strukturiert, matt | structuré, mat |
structured, matt

434829

basalt | basalte | basalt
strukturiert, matt | structuré, mat |
structured, matt

Art.	Nennmaß cote nominale nominal size cm	Herstellmaß cote de fabrication production size mm	m ²	Paket carton box	Palette palette pallet	Beanspr.-Gruppe groupe d'emploi wear resist. group	Norm Norme Standard	Trittsicherheit antidérapance non-slip	Preisgruppe groupe de prix price category
431480							Bla UGL	R10/A+B	C341 (m ²)
431481							Bla UGL	R10/A+B	C341 (m ²)
431482	5 x 5	47 x 47 x 6	11,111 Bögen plaques sheets	11 Bögen plaques sheets	35,640 m ²		Bla UGL	R10/A+B	C341 (m ²)
431483			11,488 kg / m ²	0,990 m ² 11,374 kg	409,464 kg		Bla UGL	R10/A+B	C341 (m ²)
431484							Bla UGL	R10/A+B	C341 (m ²)
434801							Bla UGL	R10/B	C347 (m ²)
434802							Bla UGL	R10/B	C347 (m ²)
434803	5 x 5	47 x 47 x 10,5	11,111 Bögen plaques sheets	11 Bögen plaques sheets	29,700 m ²		Bla UGL	R10/B	C347 (m ²)
434804			22,222 kg / m ²	0,990 m ² 22,000 kg	660,000 kg		Bla UGL	R10/B	C347 (m ²)
434805							Bla UGL	R10/B	C347 (m ²)



crema



lehm Braun
brun argile
clay-brown



kieselgrau
gris galet
pebble-grey



basalt
basalte
basalt



graphit
graphite



Mosaik | mosaïque | mosaic

Feinsteinzeugfliesen unglasiert | grès cérame fin vitrifié non-émaillés | porcelain stoneware tiles unglazed

5 x 5 cm



431480

crema
strukturiert, matt | structuré, mat |
structured, matt

431481

lehm Braun | brun argile | clay-brown
strukturiert, matt | structuré, mat |
structured, matt

431482

kieselgrau | gris galet | pebble-grey
strukturiert, matt | structuré, mat |
structured, matt

431483

basalt | basalte | basalt
strukturiert, matt | structuré, mat |
structured, matt

431484

graphit | graphite
strukturiert, matt | structuré, mat |
structured, matt

Mosaik, Verklebung
rückseitig auf Glasfasernetz,
Bogen: 297 x 297 mm

Mosaïque, collée sur trame
en fibre de verre à l'envers,
Feuille : 297 x 297 mm

Mosaic, glass fibre net
on reverse side,
Sheet: 297 x 297 mm

5 x 5 cm



434801

crema
strukturiert, matt | structuré, mat |
structured, matt

434802

lehm Braun | brun argile | clay-brown
strukturiert, matt | structuré, mat |
structured, matt

434803

kieselgrau | gris galet | pebble-grey
strukturiert, matt | structuré, mat |
structured, matt

434804

basalt | basalte | basalt
strukturiert, matt | structuré, mat |
structured, matt

434805

graphit | graphite
strukturiert, matt | structuré, mat |
structured, matt

Mosaik, Verklebung
rückseitig auf Glasfasernetz,
Bogen: 297 x 297 mm

Mosaïque, collée sur trame
en fibre de verre à l'envers,
Feuille : 297 x 297 mm

Mosaic, glass fibre net
on reverse side,
Sheet: 297 x 297 mm

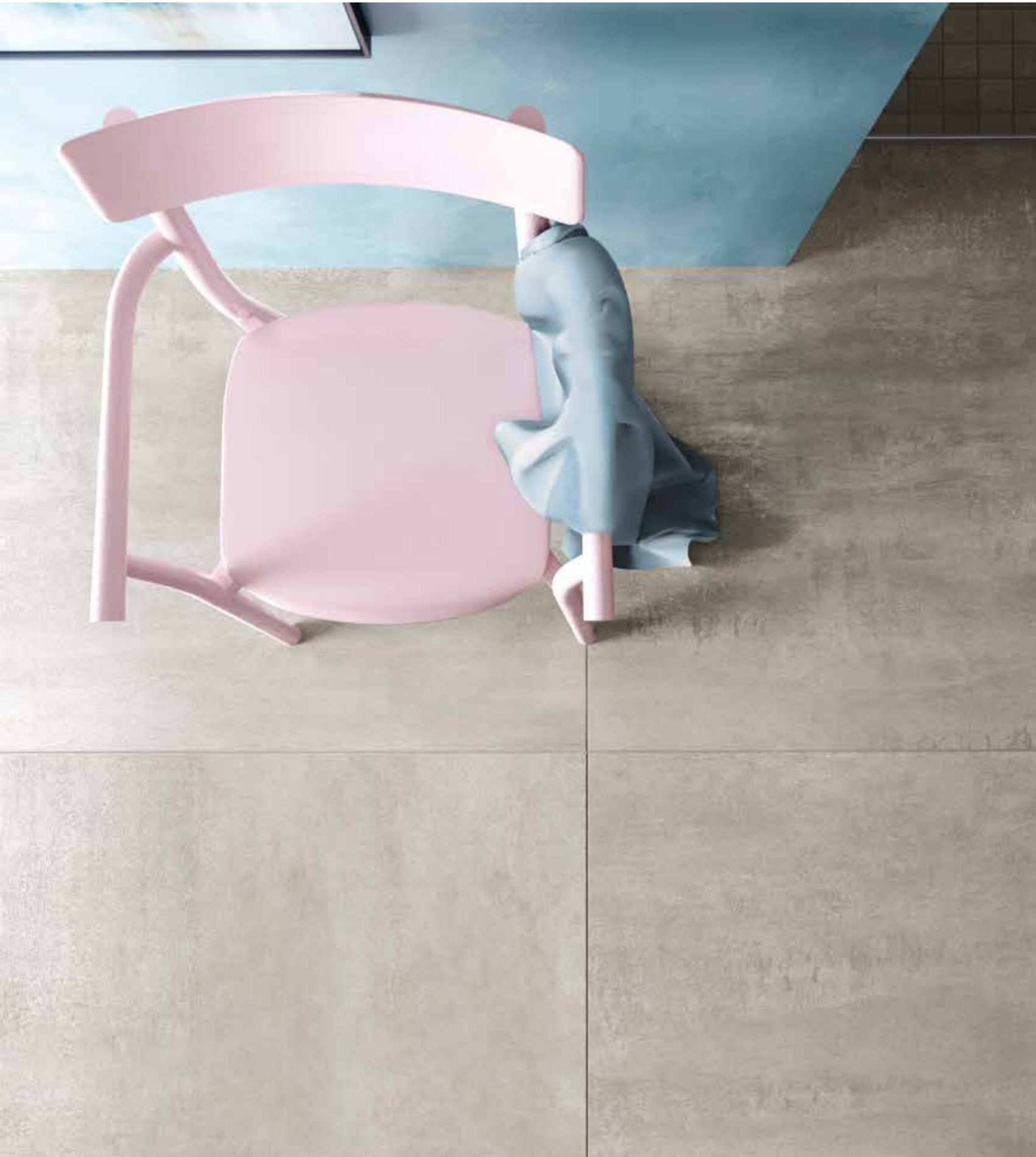

Spiel mit Bewegung und Transparenz.

Die Serie Aruba ist puristisch, harmonisch und ideal für private Bäder. In warmweißen Farben und Sandtönen gibt es sie als Wandfliese und Dekorfliese Kentia mit Palmlätter-Motiven. Die Dekorfliesen können frei nach Wahl angeordnet werden und sind richtungslos verlegbar sowie im Riegelformat erhältlich. Das und ihr spezielles Fliesenbild gibt beim Verlegen alle optischen Freiheiten. Es macht zudem die filigrane Rhythmisierung des Fliesenbildes möglich und bringt die Bewegung der Blätter besonders zur Geltung. Die Bodenfliesen runden das Angebot ab, auch in der besonders repräsentativen Dimension 60 x 120 und im optisch ansprechenden Mosaik-Format. Durch die Hytect-Oberfläche ist die gesamte Serie sehr pflegeleicht, sie wirkt antibakteriell und sorgt für hygienische Sauberkeit.

Jouez avec le mouvement et la transparence.

La série Aruba est puriste, harmonieuse et idéale pour les salles de bains privées. Dans des couleurs blanches chaudes et des tons sableux, elle est disponible en carreaux de mur et en carreaux décoratifs Kentia avec des motifs de feuilles de palmier. Les carreaux décoratifs peuvent être disposés à volonté et peuvent être posés sans direction. Ils sont également disponibles en format de traverse. Grâce à cette particularité et leur aspect spécial, ces carreaux offrent une grande liberté visuelle lors de la pose. Cela permet également le rythme filigrane du motif des carreaux et fait ressortir le mouvement des feuilles en particulier. Les carreaux de sol complètent la gamme, également dans le format particulièrement prestigieux de 60 x 120 et dans le format mosaïque visuellement attrayant. La surface Hytect rend toute la série très facile à nettoyer; elle a un effet antibactérien et assure une propreté hygiénique.

Play with movement and transparency.

The Aruba series is puristic, harmonious and ideal for private bathrooms. In warm white colors and sandy shades, it is available as wall tile and Kentia decorative tile with palm leaf motifs. The decorative tiles can be arranged as desired and can be laid without specific direction. They are available in oblong format. This and their special tile pattern offer unlimited visual freedom when laying. It also makes the filigree rhythm of the tile pattern possible and particularly emphasizes the movement of the leaves. The floor tiles round off the range, also in the particularly representative size of 60 x 120 and in the visually appealing mosaic format. The Hytect surface makes the entire series very easy to clean; it has an antibacterial effect and ensures hygienic cleanliness.





Art.	Nennmaß cote nominale nominal size cm	Herstellmaß cote de fabrication production size mm	m ²	Paket carton box	Palette palette pallet	Beanspr.-Gruppe groupe d'emploi wear resist. group	Norm Norme Standard	Trittsicherheit antidérapance non-slip	Preisgruppe groupe de prix price category
203225H	30 x 60	297 x 597 x 6	5,556 St pc	13 St pc	112,311 m ²		BIII GL		C89 (m ²)
203226H			10,279 kg	2,340 m ² 24,050 kg	1.154,400 kg		BIII GL		C89 (m ²)
323227H	30 x 90	297 x 897 x 6	3,704 St pc	8 St pc	51,836 m ²		BIII GL		C164 (m ²)
323228H			10,400 kg	2,160 m ² 22,464 kg	539,136 kg		BIII GL		C164 (m ²)

Wandfliese | carreau de mur | wall tile
Steingut glasiert | faïence émaillée | earthenware glazed

30 x 60 cm



203225H
white
eben, seidenmatt | lisse, satinée | smooth, silky-matt

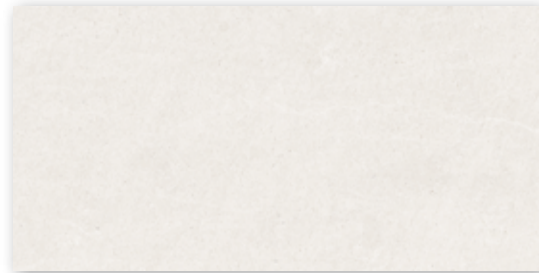

203226H
sand
eben, seidenmatt | lisse, satinée | smooth, silky-matt

30 x 90 cm

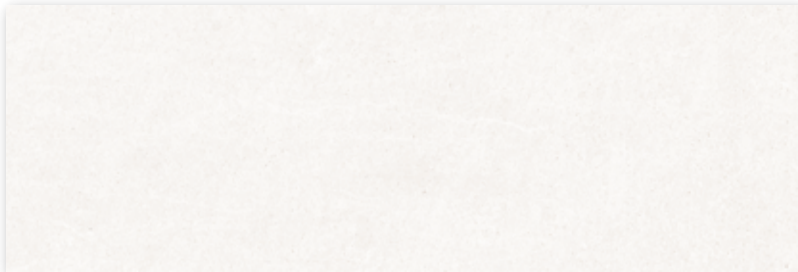

323227H
white
eben, seidenmatt | lisse, satinée | smooth, silky-matt

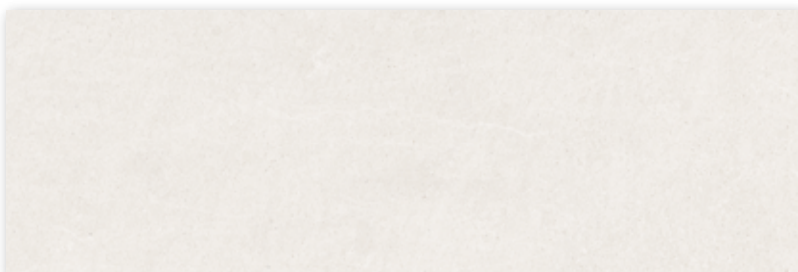

323228H
sand
eben, seidenmatt | lisse, satinée | smooth, silky-matt

Art.	Nennmaß cote nominale nominal size cm	Herstellmaß cote de fabrication production size mm	m ²	Paket carton box	Palette palette pallet	Beanspr.-Gruppe groupe d'emploi wear resist. group	Norm Norme Standard	Trittsicherheit antidérapance non-slip	Preisgruppe groupe de prix price category
203229H	30 x 60	297 x 597 x 6	5,556 St m ² 10,279 kg	13 St pc 2,340 m ² 24,050 kg	112,311 m ² 1.154,400 kg		BIII GL	C101 (m ²)	
323230H	30 x 90	297 x 897 x 6	3,704 St m ² 10,400 kg	8 St pc 2,160 m ² 22,464 kg	51,836 m ² 539,136 kg		BIII GL	C170 (m ²)	
203333H	7,5 x 25	72 x 247 x 6	53,333 St m ² 9,813 kg	18 St pc 0,338 St m ² 3,123 kg	56,700 m ² 556,416 kg		BIII GL	C248 (m ²)	

Dekorationselemente | éléments décoratifs | decoration elements

Dekorfliese Kentia | carreau décoratif Kentia | decorative element Kentia

Steingut glasiert | faïence émaillée | earthenware glazed

30 x 60 cm

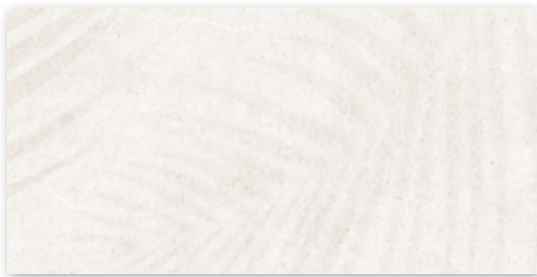

203229H

sand white
eben, seidenmatt | lisse, satinée | smooth, silky-matt



30 x 90 cm



323230H

sand white
eben, seidenmatt | lisse, satinée | smooth, silky-matt



7,5 x 25 cm Riegelformat | format de traverse | oblong format



203333H

sand white
eben, seidenmatt | lisse, satinée | smooth, silky-matt



Abgabe der Dekorationselemente ausschließlich in vollen Kartons.
Éléments décoratifs uniquement livrables en cartons entiers.
Decoration elements only available in full boxes.

Art.	Nennmaß cote nominale nominal size cm	Herstellmaß cote de fabrication production size mm	m ²	Paket carton box	Palette palette pallet	Beanspr.-Gruppe groupe d'emploi wear resist. group	Norm Norme Standard	Trittsicherheit antidérapance non-slip	Preisgruppe groupe de prix price category
430834H							Alb UGL	R9	C149 (m ²)
430835H	30 x 60	297 x 597 x 8	5,556 St pc	6 St pc	43,197 m ²		Alb UGL	R9	C149 (m ²)
430836H			17,413 kg	1,080 m ² 18,804 kg	752,160 kg		Alb UGL	R9	C149 (m ²)
430837H							Alb UGL	R9	C149 (m ²)
430838H							Alb UGL	R9	C158 (m ²)
430839H	60 x 60	597 x 597 x 8	2,778 St pc	4 St pc	43,197 m ²		Alb UGL	R9	C158 (m ²)
430840H			18,001 kg	1,440 m ² 25,920 kg	777,600 kg		Alb UGL	R9	C158 (m ²)
430841H							Alb UGL	R9	C158 (m ²)



pearl



mud



stone



graphite



Bodenfliese | carreau de sol | floor tile

Feinsteinzeugplatten unglasiert | grès fin non-émaillés | porcelain stoneware tiles unglazed

30 x 60 cm



430834H

pearl
strukturiert, matt
structuré, mat
structured, matt



430835H

mud
strukturiert, matt
structuré, mat
structured, matt

430836H

stone
strukturiert, matt
structuré, mat
structured, matt

430837H

graphite
strukturiert, matt
structuré, mat
structured, matt

60 x 60 cm



430838H

pearl
strukturiert, matt
structuré, mat
structured, matt

430839H

mud
strukturiert, matt
structuré, mat
structured, matt

430840H

stone
strukturiert, matt
structuré, mat
structured, matt

430841H

graphite
strukturiert, matt
structuré, mat
structured, matt



Art.	Nennmaß cote nominale nominal size cm	Herstellmaß cote de fabrication production size mm	m ²	Paket carton box	Palette palette pallet	Beanspr.-Gruppe groupe d'emploi wear resist. group	Norm Norme Standard	Trittsicherheit antidérapance non-slip	Preisgruppe groupe de prix price category
430842H							Alb UGL	R9	C191 (m ²)
430843H	60 x 120	597 x 1197 x 8	1,388 St pc	2 St pc	36,023 m ²		Alb UGL	R9	C191 (m ²)
430844H			17,489 kg	1,441 m ² 25,200 kg	630,000 kg		Alb UGL	R9	C191 (m ²)
430845H							Alb UGL	R9	C191 (m ²)

Bodenfliese | carreau de sol | floor tile

Feinsteinzeugplatten unglasiert | grès fin non-émaillés | porcelain stoneware tiles unglazed

60 x 120 cm



430842H

pearl
strukturiert, matt
structuré, mat
structured, matt

430843H

mud
strukturiert, matt
structuré, mat
structured, matt

430844H

stone
strukturiert, matt
structuré, mat
structured, matt

430845H

graphite
strukturiert, matt
structuré, mat
structured, matt



Art.	Nennmaß cote nominale nominal size cm	Herstellmaß cote de fabrication production size mm	m	Paket carton box	Palette palette pallet	Beanspr.-Gruppe groupe d'emploi wear resist. group	Norm Norme Standard	Trittsicherheit antidérapance non-slip	Preisgruppe groupe de prix price category
430846H							Alb UGL	R9	C466 (St pc)
430847H	30 x 60	297 x 597 x 8	1,667 St pc	6 St pc			Alb UGL	R9	C466 (St pc)
430848H			5,224 kg	3,599 m	18,804 kg		Alb UGL	R9	C466 (St pc)
430849H							Alb UGL	R9	C466 (St pc)
430850H							Alb UGL		C440 (St pc)
430851H	7 x 60	70 x 597 x 8	1,667 St pc	15 St pc			Alb UGL		C440 (St pc)
430797H			1,219 kg	8,998 m	10,969 kg		Alb UGL		C440 (St pc)
430798H							Alb UGL		C440 (St pc)



pearl



mud



stone

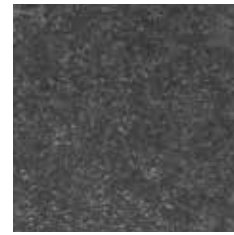

graphite



Treppenfliese | nez de marche | stair tile

Feinsteinzeugplatten unglasiert | grès fin non-émaillés | porcelain stoneware tiles unglazed

30 x 60 cm



430846H

pearl
strukturiert, matt
structuré, mat
structured, matt

430847H

mud
strukturiert, matt
structuré, mat
structured, matt

430848H

stone
strukturiert, matt
structuré, mat
structured, matt

430849H

graphite
strukturiert, matt
structuré, mat
structured, matt

Auftragsfertigung: Rückgabe und/oder Stornierung bestellter Ware nicht möglich.

Fabrication sur commande : il nous est impossible d'accepter l'annulation de commandes d'articles ou le retour d'articles.

Make-to-order production: return and/or cancellation of ordered products not possible.



Sockel, gerundet | plinthe, arrondie | skirting, rounded

Feinsteinzeugfliesen unglasiert | grès cérame fin vitrifié non-émaillés | porcelain stoneware tiles unglazed

7 x 60 cm

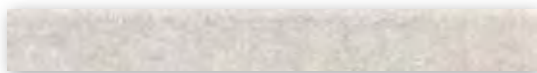

430850H

pearl
strukturiert, matt
structuré, mat
structured, matt

430851H

mud
strukturiert, matt
structuré, mat
structured, matt

430797H

stone
strukturiert, matt
structuré, mat
structured, matt

430798H

graphite
strukturiert, matt
structuré, mat
structured, matt









Zeitlos und schlicht

Die zeitlose Farbpalette und Formate erlauben wirtschaftliche Lösungen in unterschiedlichen Bereichen. Sie bietet in verschiedenen Oberflächen (matt, glänzend, gehämmert, gewellt) eine Vielzahl von Formaten vom kleinen 15 x 15 cm Produkt bis hin zu dem imposanten Großformat 35 x 100 cm.

Hors temps et simple

La gamme de couleurs hors temps de la série permet des solutions économiques dans différents domaines. Elle offre une variété de formats en différentes surfaces (mat, brillant, martelé, ondulé), du petit produit de 15 x 15 cm au grand format impressionnant de 35 x 100 cm.

Timeless and simple

The timeless colour range of the series permits economical solutions in different areas. It offers a variety of formats with diverse surfaces (matt, glossy, hammered, undulated), from the small 15 x 15 cm product to the imposing large format of 35 x 100 cm.

Art.	Nennmaß cote nominale nominal size cm	Herstellmaß cote de fabrication production size mm	m ²	Paket carton box	Palette palette pallet	Beanspr.-Gruppe groupe d'emploi wear resist. group	Norm Norme Standard	Trittsicherheit antidérapance non-slip	Preisgruppe groupe de prix price category
112000							BIII GL	A55 (m ²)	
115100	15 x 15	150 x 150 x 5,0	44,000 St pc	44 St pc	105,000 m ²		BIII GL	A55 (m ²)	
113063			9,504 kg	1,000 m ² 9,504 kg	997,920 kg		BIII GL	A112 (m ²)	
111052							BIII GL	A112 (m ²)	
531910-148	15 x 15	147 x 147 x 5,0	44,000 St pc	44 St pc	105,000 m ²		BIII GL	A46 (m ²)	
531911-148			9,416 kg	1,000 m ² 9,416 kg	988,680 kg		BIII GL	A46 (m ²)	
173339							BIII GL	A64 (m ²)	
173340	15 x 30	147 x 297 x 6,5	22,222 St pc	24 St pc	91,801 m ²		BIII GL	A64 (m ²)	
173368			10,622 kg	1,080 m ² 11,472 kg	975,120 kg		BIII GL	A58 (m ²)	
173369							BIII GL	A58 (m ²)	
213341							BIII GL	A58 (m ²)	
213342	20 x 20	197 x 197 x 6,0	25,000 St pc	25 St pc	96,000 m ²		BIII GL	A58 (m ²)	
532230-800			10,800 kg	1,000 m ² 10,800 kg	1.036,800 kg		BIII GL	A46 (m ²)	
532212-800							BIII GL	A46 (m ²)	

Wandfliese | carreau de mur | wall tile

Steingut glasiert | faïence émaillée | earthenware glazed

15 x 15 cm

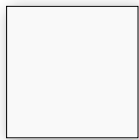

112000
weiß, eben, glänzend
blanc, lisse, brillant
white, smooth, glossy

115100
weiß, eben, matt
blanc, lisse, mat
white, smooth, matt



113063
weiß, eben, glänzend, gehämmert
blanc, lisse, brillant, martelé
white, smooth, glossy, hammered



111052
elfenbein, eben, glänzend
ivoire, lisse, brillant
ivory, smooth, glossy

15 x 30 cm

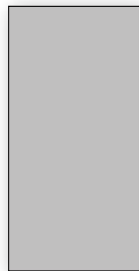

173339
hellgrau, eben, matt
gris clair, lisse, mat
light-grey, smooth, matt

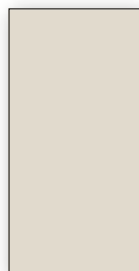

173340
hellbeige, eben, matt
beige clair, lisse, mat
light-beige, smooth, matt



173368
weiß, eben, glänzend
blanc, lisse, brillant
white, smooth, glossy

173369
weiß, eben, matt
blanc, lisse, mat
white, smooth, matt

20 x 20 cm

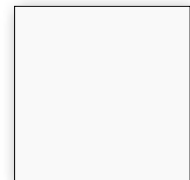

532230-800
weiß, eben, glänzend
blanc, lisse, brillant
white, smooth, glossy

532212-800
weiß, eben, matt
blanc, lisse, mat
white, smooth, matt

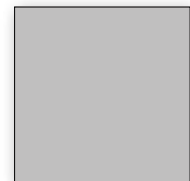

213341
hellgrau, eben, matt
gris clair, lisse, mat
light-grey, smooth, matt

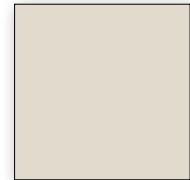

213342
hellbeige, eben, matt
beige clair, lisse, mat
light-beige, smooth, matt

Art.	Nennmaß cote nominale nominal size cm	Herstellmaß cote de fabrication production size mm	m ²	Paket carton box	Palette palette pallet	Beanspr.-Gruppe groupe d'emploi wear resist. group	Norme Norme Standard	Trittsicherheit antidérapance non-slip	Preisgruppe groupe de prix price category
538020-400							BIII GL	A46 (m ²)	
538021-400							BIII GL	A46 (m ²)	
538260-400	20 x 25	198 x 248 x 6,0	20,000 St pc	20 St pc	92,000 m ²		BIII GL	A46 (m ²)	
538261-400			10,260 kg	1,000 m ² 10,260 kg	943,920 kg		BIII GL	A46 (m ²)	
538280-400							BIII GL	A46 (m ²)	
538281-400							BIII GL	A46 (m ²)	
182763							BIII GL	A85 (m ²)	
182764	20 x 40	197 x 397 x 7,5	12,500 St pc	16 St pc	92,160 m ²		BIII GL	A85 (m ²)	
183343			12,975 kg	1,280 m ² 16,608 kg	1.195,776 kg		BIII GL	A100 (m ²)	
183344							BIII GL	A100 (m ²)	
381474	20 x 60	197 x 597 x 9,0	8,333 St pc	8 St pc	61,442 m ²		BIII GL	A85 (m ²)	
381475			15,516 kg	0,960 m ² 14,896 kg	953,344 kg		BIII GL	A85 (m ²)	

Wandfliese | carreau de mur | wall tile

Steingut glasiert | faïence émaillée | earthenware glazed

20 x 25 cm

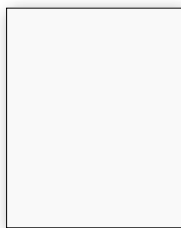

538020-400

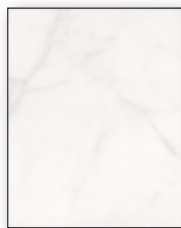
weiß, eben, glänzend
blanc, lisse, brillant
white, smooth, glossy

538260-400

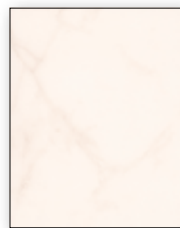
hellgrau, marmoriert, eben, glänzend
gris, clair marbré, lisse, brillant
pale, grey marbled, smooth, glossy

538280-400

beige, marmoriert, eben, glänzend
beige, clair marbré, brillant, lisse
beige, grey marbled, glossy, smooth

538021-400

weiß, eben, matt
blanc, lisse, mat
white, smooth, matt

538261-400

hellgrau, marmoriert, eben, matt
gris clair, marbré, lisse, mat
pale grey, marbled, smooth, matt

538281-400

beige, marmoriert, eben, matt
beige, clair marbré, lisse, mat
beige, grey marbled, smooth, matt

20 x 60 cm

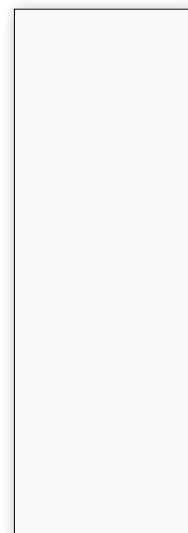

381474

weiß, eben, glänzend
blanc, lisse, brillant
white, smooth, glossy

20 x 40 cm

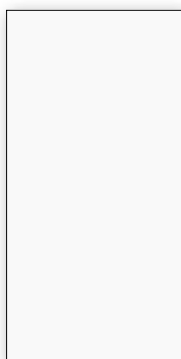

182763

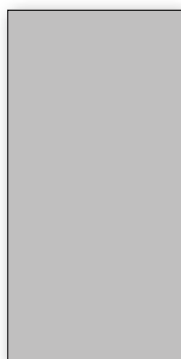
weiß, eben, glänzend
blanc, lisse, brillant
white, smooth, glossy

183343

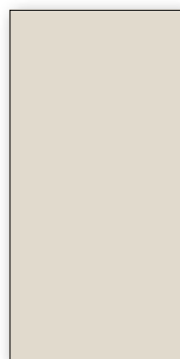
hellgrau, eben, matt
gris clair, lisse, mat
light-grey, smooth, matt

183344

hellbeige, eben, matt
beige clair, lisse, mat
light-beige, smooth, matt

182764

weiß, eben, matt
blanc, lisse, mat
white, smooth, matt

381475

weiß, eben, matt
blanc, lisse, mat
white, smooth, matt

Art.	Nennmaß cote nominale nominal size cm	Herstellmaß cote de fabrication production size mm	m ²	Paket carton box	Palette palette pallet	Beanspr.-Gruppe groupe d'emploi wear resist. group	Norm Norme Standard	Trittsicherheit antidérapance non-slip	Preisgruppe groupe de prix price category
239996							BIII GL	A49 (m ²)	
239995							BIII GL	A49 (m ²)	
239998	25 x 33	249 x 330 x 8,0	12,121 St pc	13 St pc	80,439 m ²		BIII GL	A55 (m ²)	
239997			12,969 kg	1,073 m ² 13,910 kg	1.043,250 kg		BIII GL	A55 (m ²)	
231032							BIII GL	A49 (m ²)	
231034							BIII GL	A49 (m ²)	

Wandfliese | carreau de mur | wall tile

Steingut glasiert | faïence émaillée | earthenware glazed

25 x 33 cm

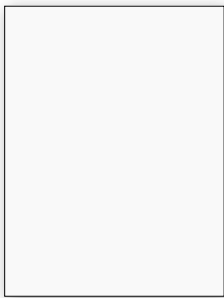

239996

weiß, glänzend, eben
blanc, brillant, lisse
white, glossy, smooth

239995

weiß, matt, eben
blanc, mat, lisse
white, matt, smooth

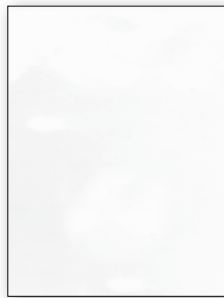

239998

weiß, glänzend, gewellt, eben
blanc, brillant, ondulé, lisse
white, glossy, undulated, smooth

239997

weiß, matt, gewellt, eben
blanc, mat, ondulé, lisse
white, matt, undulated, smooth

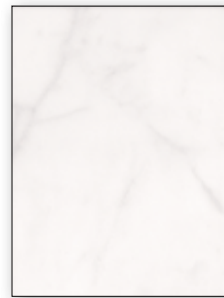

231032

hellgrau, marmoriert, glänzend, eben
gris, clair marbré, brillant, lisse
pale, grey marbled, glossy, smooth

231034

hellgrau, marmoriert, matt, eben
gris clair, marbré, mat, lisse
pale grey, marbled, matt, smooth

Art.	Nennmaß cote nominale nominal size cm	Herstellmaß cote de fabrication production size mm	m ²	Paket carton box	Palette palette pallet	Beanspr.-Gruppe groupe d'emploi wear resist. group	Norm Norme Standard	Trittsicherheit antidérapance non-slip	Preisgruppe groupe de prix price category
282115R-02	30 x 60	297 x 597 x 9,0	5,556 St pc	9 St pc	77,754 m ²		BIII GL	A109 (m ²)	
282116R-02			15,279 kg	1,620 m ² 24,750 kg	1.188,000 kg		BIII GL	A109 (m ²)	
280374							BIII GL	A91 (m ²)	
280375							BIII GL	A91 (m ²)	
280718	30 x 60	297 x 597 x 9,0	5,556 St pc	9 St pc	77,754 m ²		BIII GL	A100 (m ²)	
280719			14,946 kg	1,620 m ² 24,210 kg	1.162,080 kg		BIII GL	A100 (m ²)	
280871							BIII GL	A100 (m ²)	
280872							BIII GL	A100 (m ²)	
283345							BIII GL	A100 (m ²)	
283346							BIII GL	A100 (m ²)	
203264							BIII GL	A52 (m ²)	
203265	30 x 60	297 x 597 x 6,0	5,556 St pc	13 St pc	112,311 m ²		BIII GL	A52 (m ²)	
203444			10,279 kg	2,339 m ² 24,050 kg	1.154,444 kg		BIII GL	A58 (m ²)	
203445							BIII GL	A58 (m ²)	

Wandfliese | carreau de mur | wall tile

Steingut glasiert | faïence émaillée | earthenware glazed

30 x 60 cm

neu · nouveau · new

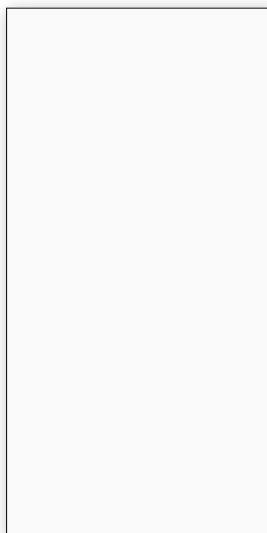

280374

weiß, glänzend, eben
blanc, brillant, lisse
white, glossy, smooth

280375

weiß, matt, eben
blanc, mat, lisse
white, matt, smooth

280718

weiß, glänzend, gewellt, eben
blanc, brillant, ondulé, lisse
white, glossy, undulated, smooth

280719

weiß, matt, gewellt, eben
blanc, mat, ondulé, lisse
white, matt, undulated, smooth

280871

sandbeige, glänzend, eben
beige sable, brillant, lisse
sand-beige, glossy, smooth

280872

sandbeige, matt, eben
beige sable, mat, lisse
sand-beige, matt, smooth

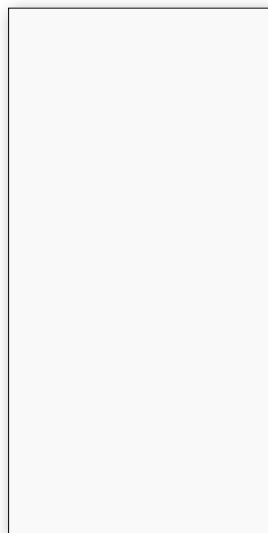

203264

weiß, glänzend, eben
blanc, brillant, lisse
white, glossy, smooth

203265

weiß, matt, eben
blanc, mat, lisse
white, matt, smooth

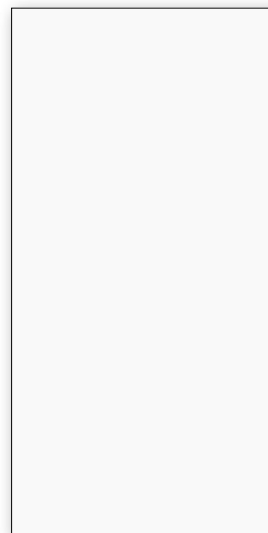

282115R-02

weiß, glänzend, eben
blanc, brillant, lisse
white, glossy, smooth

282116R-02

weiß, matt, eben
blanc, mat, lisse
white, matt, smooth



203444

weiß, marmoriert, glänzend, eben
blanc, marbré, brillant, lisse
white, marbled, glossy, smooth

203445

weiß, marmoriert, matt, eben
blanc, marbré, mat, lisse
white, marbled, matt, smooth



Art.	Nennmaß cote nominale nominal size cm	Herstellmaß cote de fabrication production size mm	m ² /m	Paket carton box	Palette palette pallet	Beanspr.-Gruppe groupe d'emploi wear resist. group	Norm Norme Standard	Trittsicherheit antidérapance non-slip	Preisgruppe groupe de prix price category
323260	30 x 90	297 x 897 x 6,0	3,704 St pc	8 St pc	51,836 m ²		BIII GL	A148 (m ²)	
323261			10,400 kg	2,160 m ² 22,464 kg	539,094 kg		BIII GL	A148 (m ²)	
391589	30 x 90	297 x 897 x 10,5	3,704 St pc	5 St pc	32,397 m ²		BIII GL	A166 (m ²)	
391590			17,976 kg	1,350 m ² 24,265 kg	582,360 kg		BIII GL	A166 (m ²)	
363335	35 x 100	347 x 997 x 6,0	2,857 St pc	5 St pc	70,000 m ²		BIII GL	A154 (m ²)	
363336			10,108 kg	1,750 m ² 17,690 kg	707,600 kg		BIII GL	A154 (m ²)	
533436-198	1 x 20	10 x 197 x 6,0	5,000 St pc	100 St pc			BIII GL	A423 (St pc)	
			0,125 kg	20,000 m 2,500 kg			BIII GL		
533434-198	4,5 x 20	45 x 197 x 6,0	5,000 St pc	72 St pc			BIII GL	A445 (St pc)	
			0,505 kg	14,400 m 7,272 kg			BIII GL		

Wandfliese | carreau de mur | wall tile

Steingut glasiert | faïence émaillée | earthenware glazed

30 x 90 cm

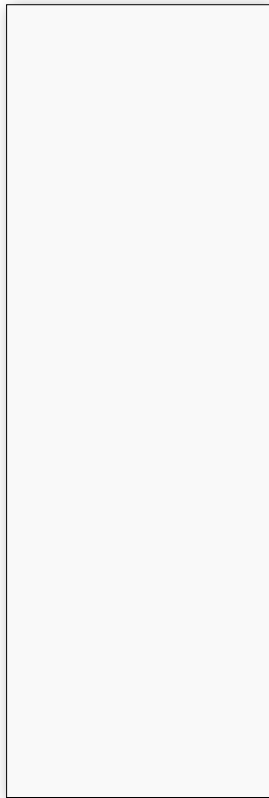

323260



weiß, glänzend, eben
blanc, brillant, lisse
white, glossy, smooth

323261



weiß, matt, eben
blanc, mat, lisse
white, matt, smooth

391589

weiß, glänzend, eben
blanc, brillant, lisse
white, glossy, smooth

391590

weiß, matt, eben
blanc, mat, lisse
white, matt, smooth

35 x 100 cm

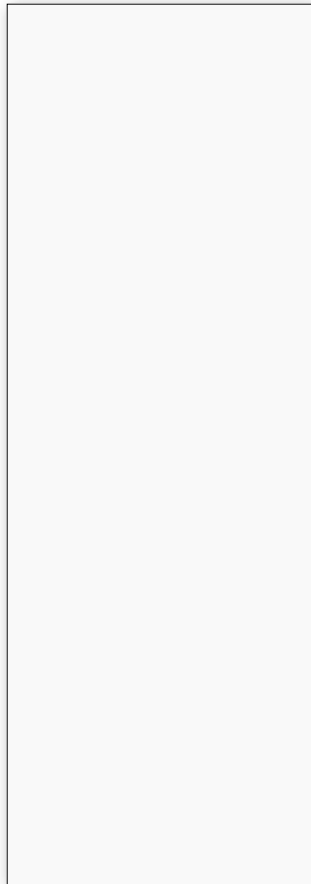

363335



weiß, glänzend, eben
blanc, brillant, lisse
white, glossy, smooth

363336



weiß, matt, eben
blanc, mat, lisse
white, matt, smooth

Listel Candy

Steingut glasiert | faïence émaillée | earthenware glazed

1 x 20 cm



533436-198

candy
seidenmatt | satiné | silky-matt

4,5 x 20 cm



533434-198

candy
seidenmatt | satiné | silky-matt



Edle Marmoroptik

Der natürliche Ausdruck des italienischen Marmors und das großzügige Format machen Bliss zu etwas Besonderem. Besonders eindrucksvoll ist die Verbindung der Grundfliesen mit dem frisch-farbigem Flächendekor Paradise. Die Fliesen harmonisieren mit unterschiedlichen Bodenfliesenserien, sie sind Hytect-veredelt und daher besonders hygienisch.

Visuel noble du marbre

L'expression naturelle du marbre italien et le format généreux font de Bliss quelque chose de spécial. La combinaison des carreaux de base avec le décor de surface en couleurs fraîches Paradise est particulièrement impressionnant. Les carreaux de base s'harmonisent avec différentes séries de carreaux de sol. Les carreaux à finition Hytect sont donc particulièrement hygiéniques.

Noble marble look

The natural expression of Italian marble and the generous format make Bliss something special. The combination of the basic tiles with the freshly colored Paradise surface decor is particularly impressive. The basic tiles harmonize with various floor tile series, the tiles are Hytect-coated and therefore particularly hygienic.





Art.	Nennmaß cote nominale nominal size cm	Herstellmaß cote de fabrication production size mm	m ²	Paket carton box	Palette palette pallet	Beanspr.-Gruppe groupe d'emploi wear resist. group	Norme Norme Standard	Trittsicherheit antidérapance non-slip	Preisgruppe groupe de prix price category
363428H	35 x 100	347 x 997 x 6	2,857 St pc	5 St pc	70,000 m ²		BIII GL		W156 (m ²)
363429H			10,108 kg	1,750 m ² 17,690 kg	707,600 kg		BIII GL		W156 (m ²)

Wandfliese | carreau de mur | wall tile
Steingut glasiert | faïence émaillée | earthenware glazed

35 x 100 cm



363428H

white calacatta
eben, seidenmatt, | lisse, satinée | smooth, silky-glossy

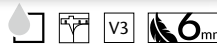

363429H

white calacatta
eben, glänzend | lisse, brillant | smooth, glossy

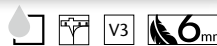

Art.	Nennmaß cote nominale nominal size cm	Herstellmaß cote de fabrication production size mm	m ²	Paket carton box	Palette palette pallet	Beanspr.-Gruppe groupe d'emploi wear resist. group	Norm Norme Standard	Trittsicherheit antidérapance non-slip	Preisgruppe groupe de prix price category
363430H	35 x 100	347 x 997 x 6	2,857 St pc 10,108 kg	5 St pc 1,750 m ² 17,690 kg	70,000 m ² 707,600 kg		BIII GL		W162 (m ²)

Dekorationselemente | éléments décoratifs | decoration elements

Dekorfliese Paradise | carreau décoratif Paradise | decorative element Paradise

Steingut glasiert | faïence émaillée | earthenware glazed

35 x 100 cm

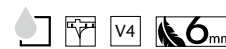

363430H

green-blue Mix
eben, seidenmatt, | lisse, satinée | smooth, silky-glossy

Bei der von Ihnen ausgewählten Dekoration handelt es sich um ein hochwertiges Produkt aus Steingut glasiert. Die Dekoration besteht aus unterschiedlichen Einzelbildern. Die Anschlüsse der Einzelbilder sind bewusst frei gestaltet und verbinden sich somit nicht in der fortlaufenden Verlegung. Die Motivzusammenstellung im Karton kann produktionsbedingt variieren.

Le décor que vous avez choisi est un produit en faïence émaillée de grande qualité. Ce décor se compose d'images individuelles différentes. Les correspondances de chacune de ces images individuelles sont conçues de façon délibérément libre et ne se lient donc pas dans une pose continue. La combinaison de motifs dans le carton peut varier en fonction de la production.

The decoration you have chosen is a high-quality product made of glazed earthenware. The decoration consists of different individual pictures. The connections of the individual pictures are deliberately designed freely and thus do not connect in the continuous laying. The composition of the motifs in the box may vary due to production reasons.

Abgabe der Dekorationselemente ausschließlich in vollen Kartons.
Éléments décoratifs uniquement livrables en cartons entiers.
Decoration elements only available in full boxes.





Von Holz inspiriert

Mit ihrer dezenten Erinnerung an Holzoberflächen ist Cedra die perfekte Wahl für eine wohnliche Badgestaltung. Die beiden Wandfliesenfarben in zwei Formaten lassen sich gut mit den Bordüren kombinieren. Diese Bordüren, die mit und ohne Einleger aus Feinsteinzeug verfügbar sind, setzen optische Akzente. Sie greifen die drei klassischen Farben des Bodens auf. Besonders praktisch: Neben den drei Bodenformaten kann man den Duschboden mit einem passenden Mosaik in R10/B fortführen. Die Wandfliesen sind durch ihre Hytect-Oberfläche besonders reinigungsfreundlich.

Inspiré par le bois

Avec sa réminiscence subtile des surfaces en bois, Cedra est le choix idéal pour une salle de bains au design accueillant. Les deux couleurs de carreaux de mur en deux formats se combinent bien avec les bordures. Ces bordures, disponibles avec et sans cabochons en grès cérame fin vitrifié, mettent des accents visuels. Elles reprennent les trois couleurs classiques du sol. Particulièrement pratique : en plus des trois formats de sol, le sol de la douche peut être continué sous forme de mosaïque assortie en R10/B. Les carreaux de mur sont particulièrement faciles à nettoyer grâce à leur surface Hytect.

Inspired by wood

With its subtle reminiscence of wood surfaces, Cedra is the perfect choice for a homely bathroom design. The two wall tile colours in two formats can be harmoniously combined with the borders. These borders, which are available with and without porcelain stoneware inlays, set visual accents. They pick up the three classic colours of the floor. Particularly practical: in addition to the three floor formats, the shower floor can be continued with a matching mosaic in R10/B. The wall tiles are particularly easy to clean thanks to their Hytect surface.

Art.	Nennmaß cote nominale nominal size cm	Herstellmaß cote de fabrication production size mm	m ²	Paket carton box	Palette palette pallet	Beanspr.-Gruppe groupe d'emploi wear resist. group	Norm Norme Standard	Trittsicherheit antidérapance non-slip	Preisgruppe groupe de prix price category
281726	30 x 60	297 x 597 x 9	5,556 St pc 14,946 kg	9 St pc 1,620 m ² 24,210 kg	77,754 m ² 1.162,080 kg		BIII GL		C107 (m ²)
281727							BIII GL		C107 (m ²)
392720	30 x 90	297 x 897 x 10,5	3,704 St pc 17,976 kg	5 St pc 1,350 m ² 24,265 kg	32,397 m ² 582,360 kg		BIII GL		C179 (m ²)
392721							BIII GL		C179 (m ²)

Wandfliese | carreau de mur | wall tile
Steingut glasiert | faïence émaillée | earthenware glazed

30 x 60 cm



281726
weiß-creme | blanc crème | white-cream
eben, seidenmatt, | lisse, satinée | smooth, silky-glossy



281727
beige
eben, seidenmatt, | lisse, satinée | smooth, silky-glossy

30 x 90 cm



392720
weiß-creme | blanc crème | white-cream
eben, seidenmatt, | lisse, satinée | smooth, silky-glossy



392721
beige
eben, seidenmatt, | lisse, satinée | smooth, silky-glossy

Art.	Nennmaß cote nominale nominal size cm	Herstellmaß cote de fabrication production size mm	m	Paket carton box	Palette palette pallet	Beanspr.-Gruppe groupe d'emploi wear resist. group	Norm Norme Standard	Trittsicherheit antidérapance non-slip	Preisgruppe groupe de prix price category
281728							Bla UGL		C474 (St pc)
281730							Bla UGL		C474 (St pc)
281732	10 x 60	97 x 597 x 10,5	1,667 St pc	4 St pc			Bla UGL		C474 (St pc)
281729			2,167 kg	2,400 m	5,200 kg		Bla UGL		C466 (St pc)
281731							Bla UGL		C466 (St pc)
281733							Bla UGL		C466 (St pc)

Dekorationselemente | éléments décoratifs | decoration elements

Bordüre | Bordure | Border

Feinsteinzeugfliesen unglasiert | grès cérame fin vitrifié non-émaillés | porcelain stoneware tiles unglazed

10 x 60 cm

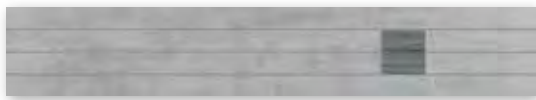

281728

grau | gris | grey
eben, matt | lisse, mat | smooth, matt
mit Feinsteinzeuginleger
avec cabochon en grès cérame fin vitrifié
with porcelain stoneware insert

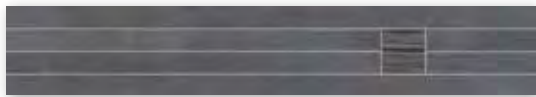

281730

anthrazit | anthracite
eben, matt | lisse, mat | smooth, matt
mit Feinsteinzeuginleger
avec cabochon en grès cérame fin vitrifié
with porcelain stoneware insert

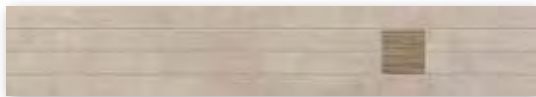

281732

schlamm | boue | mud-brown
eben, matt | lisse, mat | smooth, matt
mit Feinsteinzeuginleger
avec cabochon en grès cérame fin vitrifié
with porcelain stoneware insert



281729

grau | gris | grey
eben, matt | lisse, mat | smooth, matt

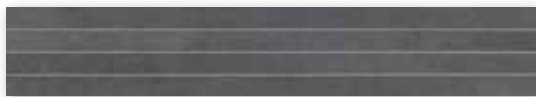

281731

anthrazit | anthracite
eben, matt | lisse, mat | smooth, matt

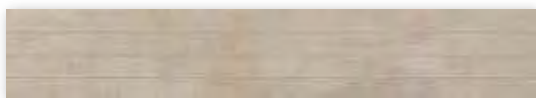

281733

schlamm | boue | mud-brown
eben, matt | lisse, mat | smooth, matt



Abgabe der Dekorationselemente ausschließlich in vollen Kartons.
Éléments décoratifs uniquement livrables en cartons entiers.
Decoration elements only available in full boxes.

Bordüre, Verklebung rückseitig auf Glasfasernetz,
Bogen: 97 x 597 mm

Bordure, collée sur trame en fibre de verre à
l'envers, Feuille : 97 x 597 mm

Border, glass fibre net on reverse side,
Sheet: 97 x 597 mm

Art.	Nennmaß cote nominale nominal size cm	Herstellmaß cote de fabrication production size mm	m	Paket carton box	Palette palette pallet	Beanspr.-Gruppe groupe d'emploi wear resist. group	Norm Norme Standard	Trittsicherheit antidérapance non-slip	Preisgruppe groupe de prix price category
392723							Bla UGL		C491 (St pc)
392725							Bla UGL		C491 (St pc)
392727	10 x 90	97 x 897 x 10,5	1,111 St pc	2 St pc			Bla UGL		C491 (St pc)
392724			2,166 kg	1,800 m	3,900 kg		Bla UGL		C486 (St pc)
392726							Bla UGL		C486 (St pc)
392728							Bla UGL		C486 (St pc)

Dekorationselemente | éléments décoratifs | decoration elements

Bordüre | Bordure | Border

Feinsteinzeugfliesen unglasiert | grès cérame fin vitrifié non-émaillés | porcelain stoneware tiles unglazed

10 x 90 cm



392723

grau | gris | grey
eben, matt | lisse, mat | smooth, matt
mit Feinsteinzeuginleger
avec cabochon en grès cérame fin vitrifié
with porcelain stoneware insert

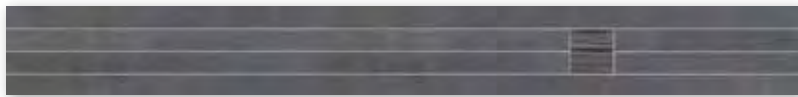

392725

anthrazit | anthracite
eben, matt | lisse, mat | smooth, matt
mit Feinsteinzeuginleger
avec cabochon en grès cérame fin vitrifié
with porcelain stoneware insert

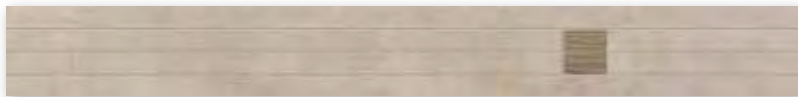

392727

schlamm | boue | mud-brown
eben, matt | lisse, mat | smooth, matt
mit Feinsteinzeuginleger
avec cabochon en grès cérame fin vitrifié
with porcelain stoneware insert



392724

grau | gris | grey
eben, matt | lisse, mat | smooth, matt



392726

anthrazit | anthracite
eben, matt | lisse, mat | smooth, matt

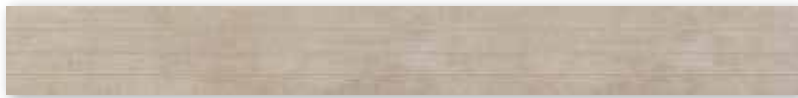

392728

schlamm | boue | mud-brown
eben, matt | lisse, mat | smooth, matt



Bordüre, Verklebung rückseitig auf Glasfasernetz,
Bogen: 97 x 897 mm

Bordure, collée sur trame en fibre de verre à
l'envers, Feuille : 97 x 897 mm

Border, glass fibre net on reverse side,
Sheet: 97 x 897 mm

Abgabe der Dekorationselemente ausschließlich in vollen Kartons.
Éléments décoratifs uniquement livrables en cartons entiers.
Decoration elements only available in full boxes.

Art.	Nennmaß cote nominale nominal size cm	Herstellmaß cote de fabrication production size mm	m ²	Paket carton box	Palette palette pallet	Beanspr.-Gruppe groupe d'emploi wear resist. group	Norm Norme Standard	Trittsicherheit antidérapance non-slip	Preisgruppe groupe de prix price category
433692							Bla UGL	R9	C134 (m ²)
433693	30 x 60	297 x 597 x 10,5	5,556 St pc	6 St pc	43,197 m ²		Bla UGL	R9	C134 (m ²)
433694			23,224 kg	1,080 m ² 25,080 kg	1.003,200 kg		Bla UGL	R9	C134 (m ²)
434757							Bla UGL	R9	C149 (m ²)
434758	60 x 60	597 x 597 x 10,5	2,778 St pc	3 St pc	38,877 m ²		Bla UGL	R9	C149 (m ²)
434759			23,769 kg	1,080 m ² 25,668 kg	924,048 kg		Bla UGL	R9	C149 (m ²)



anthrazit
anthracite



grau
gris
grey

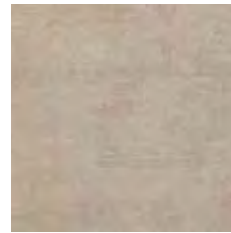

schlamm
boue
mud-brown



Bodenfliese | carreau de sol | floor tile

Feinsteinzeugfliesen unglasiert | grès cérame fin vitrifié non-émaillés | porcelain stoneware tiles unglazed

30 x 60 cm



433692

anthrazit | anthracite
eben, matt | lisse, mat | smooth, matt



433693

grau | gris | grey
eben, matt | lisse, mat | smooth, matt

433694

schlamm | boue | mud-brown
eben, matt | lisse, mat | smooth, matt

60 x 60 cm



434757

anthrazit | anthracite
eben, matt | lisse, mat | smooth, matt



434758

grau | gris | grey
eben, matt | lisse, mat | smooth, matt

434759

schlamm | boue | mud-brown
eben, matt | lisse, mat | smooth, matt

Art.	Nennmaß cote nominale nominal size cm	Herstellmaß cote de fabrication production size mm	m ²	Paket carton box	Palette palette pallet	Beanspr.-Gruppe groupe d'emploi wear resist. group	Norm Norme Standard	Trittsicherheit antidérapance non-slip	Preisgruppe groupe de prix price category
433737							Bla UGL	R9	C149 (m ²)
433738	45 x 90	447 x 897 x 10,5	2,470 St pc	2 St pc	32,389 m ²		Bla UGL	R9	C149 (m ²)
433739			23,070 kg	0,810 m ² 18,680 kg	747,200 kg		Bla UGL	R9	C149 (m ²)



anthrazit
anthracite
anthracite

V2



grau
gris
grey

V2

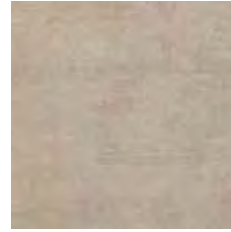

schlamm
lisse
mud-brown

V3

45 x 90 cm



433737
anthrazit | anthracite
eben, matt | lisse, mat | smooth, matt

433738
grau | gris | grey
eben, matt | lisse, mat | smooth, matt

433739
schlamm | boue | mud-brown
eben, matt | lisse, mat | smooth, matt

Achtung: Sonderpalette. Keine Rücknahme, kein Umtausch.
Attention : palette spéciale. Pas de retour, pas d'échange.
Please note: special pallet. No return, no exchange.

Art.	Nennmaß cote nominale nominal size cm	Herstellmaß cote de fabrication production size mm	m ² /m	Paket carton box	Palette palette pallet	Beanspr.-Gruppe groupe d'emploi wear resist. group	Norm Norme Standard	Trittsicherheit antidérapance non-slip	Preisgruppe groupe de prix price category
433695							Bla UGL		C440 (St pc)
433696	7 x 60	70 x 597 x 10,5	1,667 St pc / m	22 St pc			Bla UGL		C440 (St pc)
433697			1,584 kg	13,197 m	20,900 kg		Bla UGL		C440 (St pc)
433757							Bla UGL	R10/B	C347 (m ²)
433756	5 x 5	47 x 47 x 10,5	11,111 Bögen plaques sheets	11 Bögen plaques sheets	29,700 m ²		Bla UGL	R10/B	C347 (m ²)
433758			22,222 kg / m ²	0,990 m ²	22,000 kg	660,000 kg	Bla UGL	R10/B	C347 (m ²)

Sockel, gerundet | plinthe, arrondie | skirting, rounded

Feinsteinzeugfliesen unglasiert | grès cérame fin vitrifié non-émaillés | porcelain stoneware tiles unglazed

7 x 60 cm



433695

anthrazit | anthracite
eben, matt | lisse, mat | smooth, matt

433696

grau | gris | grey
eben, matt | lisse, mat | smooth, matt

433697

schlamm | boue | mud-brown
eben, matt | lisse, mat | smooth, matt

Mosaik | mosaïque | mosaic

Feinsteinzeugfliesen unglasiert | grès cérame fin vitrifié non-émaillés | porcelain stoneware tiles unglazed

5 x 5 cm



433757

anthrazit | anthracite
eben, matt | lisse, mat | smooth, matt

433756

grau | gris | grey
eben, matt | lisse, mat | smooth, matt

433758

schlamm | boue | mud-brown
eben, matt | lisse, mat | smooth, matt

Mosaik, Verklebung rückseitig auf Glasfasernetz,
Bogen: 297 x 297 mm

Mosaïque, collée sur trame en fibre de verre à
l'envers, Feuille : 297 x 297 mm

Mosaic, glass fibre net on reverse side,
Sheet: 297 x 297 mm

Weiches Farbspiel zwischen Beton und Sand

Schattig, wolkig, puristisch. Geschliffener Beton mit Einschlüssen von Sand und feiner Gesteinskörnung: das ist Como. Sinnbild für ein Material, das viele Freiheiten lässt für Eigenkreationen. Und doch so schlicht, dass es sich nahezu überall anpasst. Für ein stylisches Ambiente mit Loft-Charakter, schlichte Ästhetik oder pure Ursprünglichkeit. Für Akzente sorgen die Dekorelemente Script mit Farb- und Reliefdruck in den Farben der Wandfliesen oder die Bordüre Block in Graphitschwarz oder Sandbeige.

Jeu de couleurs doux entre le béton et le sable

Ombreux, nuageux, puriste. Como, c'est du béton poncé avec des inclusions de sable et une granularité de roche fine. Le symbole d'un matériau qui permet de grandes libertés pour des créations originales – et pourtant si simple qu'il s'adapte presque partout. Pour une ambiance stylisée à caractère de loft, une esthétique simple ou authentique pure. Les éléments décoratifs Script avec impression en couleur et en relief dans les coloris des carreaux de mur ou la bordure Block en noir graphite ou beige sable posent des accents.

Flowing play of colors between concrete and sand

Shadowy, cloudy, purist. Polished concrete with inclusions featuring sand and fine stone grains, Como is symbolic of a material which provides plenty of scope for individual creations. Yet so simple that it can be used practically anywhere. For a stylish ambience with a loft character, elegantly aesthetic or purely original. Highlights are provided by decorative elements such as Script, with color and relief print in the wall tile colors of glacier-white or natural beige as well as the border Block in graphite-black or sand-beige.





Art.	Nennmaß cote nominale nominal size cm	Herstellmaß cote de fabrication production size mm	m ²	Paket carton box	Palette palette pallet	Beanspr.-Gruppe groupe d'emploi wear resist. group	Norm Norme Standard	Trittsicherheit antidérapance non-slip	Preisgruppe groupe de prix price category
282743H	30 x 60	297 x 597 x 9	5,556 St pc	9 St pc	77,754 m ²		BIII GL		W90 (m ²)
282745H			14,946 kg	1,620 m ² 24,210 kg	1.162,080 kg		BIII GL		W90 (m ²)
282749H	30 x 60	297 x 597 x 9	5,556 St pc	8 St pc			BIII GL		W102 (m ²)
282751H			14,946 kg	1,440 m ² 21,520 kg			BIII GL		W102 (m ²)

Wandfliese | carreau de mur | wall tile

Steingut glasiert | faïence émaillée | earthenware glazed

30 x 60 cm

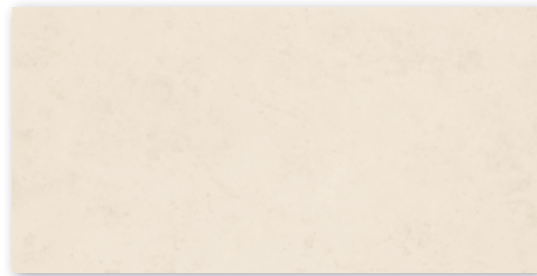
**282743H**gletscherweiß | blanc glacier | glacier-white
eben, seidenmatt | lisse, satiné | smooth, silky-matt**282745H**naturbeige | beige nature | natural beige
eben, seidenmatt | lisse, satiné | smooth, silky-matt

Dekorationselemente | éléments décoratifs | decoration elements

Dekorfliese Script | carreau décoratif Script | decorative element Script

Steingut glasiert | faïence émaillée | earthenware glazed

30 x 60 cm

**282749H**gletscherweiß | blanc glacier | glacier-white
eben, seidenmatt | lisse, satiné | smooth, silky-matt**282751H**naturbeige | beige nature | natural beige
eben, seidenmatt | lisse, satiné | smooth, silky-matt

Art.	Nennmaß cote nominale nominal size cm	Herstellmaß cote de fabrication production size mm	m	Paket carton box	Palette palette pallet	Beanspr.-Gruppe groupe d'emploi wear resist. group	Norm Norme Standard	Trittsicherheit antidérapance non-slip	Preisgruppe groupe de prix price category
282746	4 x 60	40 x 597 x 10,5	1,667 St pc	3 St pc			Bla UGL		W448 (Set)
282748			0,929 kg	1,800 m	1,671 kg		Bla UGL		W448 (Set)

Dekorationselemente | éléments décoratifs | decoration elements

Bordüre Block | bordure Block | border Block

Feinsteinzeugfliesen unglasiert | grès cérame fin vitrifié non-émaillés | porcelain stoneware tiles unglazed

4 x 60 cm

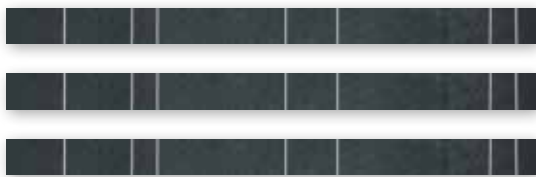

282746

graphitschwarz | noir graphite | graphite-black
eben, matt | lisse, mat | smooth, matt
3er-Set | jeu de 3 carreaux | set of 3 tiles

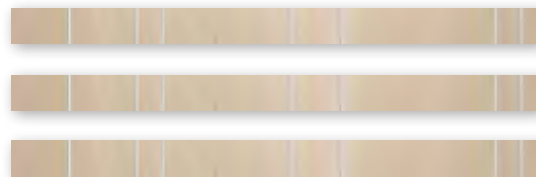

282748

sandbeige | beige sable | sand-beige
eben, matt | lisse, mat | smooth, matt
3er-Set | jeu de 3 carreaux | set of 3 tiles



Como Verlegebeispiele | Exemples de pose Como | Como laying examples

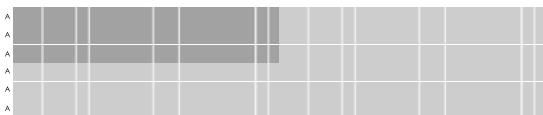

Abgabe der Dekorationselemente ausschließlich in vollen Kartons.
Éléments décoratifs uniquement livrables en cartons entiers.
Decoration elements only available in full boxes.





Harmonisches Wohngefühl

Die Serie Concrete schafft mit ihren Wandfliesen, in den Farben silbergrau und sandbeige ein natürliches und harmonisches Wohnambiente. Mit den Mosaikfliesen Screen und Stripes in graphit und sandbeige und den passenden Bordüren lassen sich stimmige Akzente setzen. Die Wandfliesen sind durch ihre Hytect-Oberfläche reinigungsfreundlich.

Un confort de vie harmonieux

Avec ses carreaux de mur en gris argenté et beige sable, la série Concrete crée une ambiance de vie naturelle et harmonieuse. Les carreaux de mosaïque Screen et Stripes en graphite et beige sable et les bordures assorties permettent de placer des accents de façon harmonieuse. Les carreaux de mur sont faciles à nettoyer grâce à leur surface Hytect.

Harmonious feeling of homeliness

With its wall tiles in the colors silver-grey and sand-beige, the series Concrete creates a natural and harmonious living ambience. Attractive accents can be set with the Screen and Stripes mosaic tiles in graphite and sand-beige and the matching borders. The wall tiles are easy to clean thanks to their Hytect surface.



Art.	Nennmaß cote nominale nominal size cm	Herstellmaß cote de fabrication production size mm	m ² /m	Paket carton box	Palette palette pallet	Beanspr.-Gruppe groupe d'emploi wear resist. group	Norm Norme Standard	Trittsicherheit antidérapance non-slip	Preisgruppe groupe de prix price category
280345	30 x 60	296 x 595 x 9	5,556 St pc / m ²	9 St pc	77,754 m ²		BIII GL		C71 (m ²)
280354			14,946 kg	1,620 m ² 24,210 kg	1.162,080 kg		BIII GL		C71 (m ²)
280349-73	30 x 60	297 x 597 x 10,5	1,667 St pc / m	2 St pc			Bla UGL		C486 (St pc)
			6,668 kg	1,200 m 8,000 kg			Bla UGL		
280360	30 x 60	296 x 595 x 10	1,667 St pc / m	2 St pc			Bla UGL		C486 (St pc)
			6,668 kg	1,200 m 8,000 kg			Bla UGL		

Wandfliese | carreau de mur | wall tile
Steingut glasiert | faïence émaillée | earthenware glazed

30 x 60 cm

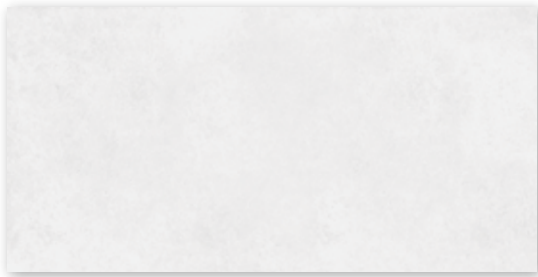

280345
silbergrau | gris argenté | silver-grey
strukturiert, seidenmatt | structuré, satiné | structured, silky-matt



280354
sandbeige | beige sable | sand-beige
strukturiert, seidenmatt | structuré, satiné | structured, silky-matt

Dekorationselemente | éléments décoratifs | decoration elements

Mosaikfliese | carreau à mosaïques | mosaic tile
Feinsteinzeugfliesen unglasiert | grès cérame fin vitrifié non-émaillés | porcelain stoneware tiles unglazed

30 x 60 cm



280349-73
Stripes
anthrazit | anthracite
strukturiert, matt | structuré, mat | structured, matt



280360
Stripes
sandbeige | beige sable | sand-beige
strukturiert, matt | structuré, mat | structured, matt

Farbabweichung zum Standard.
Les couleurs représentées peuvent différer du standard.
Colour deviation from the standard.

Abgabe der Dekorationselemente ausschließlich in vollen Kartons.
Éléments décoratifs uniquement livrables en cartons entiers.
Decoration elements only available in full boxes.

Art.	Nennmaß cote nominale nominal size cm	Herstellmaß cote de fabrication production size mm	m	Paket carton box	Palette palette pallet	Beanspr.-Gruppe groupe d'emploi wear resist. group	Norm Norme Standard	Trittsicherheit antidérapance non-slip	Preisgruppe groupe de prix price category
280351-73	30 x 60	297 x 597 x 10,5	1,667 St pc 6,668 kg	2 St pc 1,200 m 8,000 kg			Bla UGL Bla UGL	C491 (St pc)	
280362	30 x 60	296 x 595 x 10	1,667 St pc 6,668 kg	2 St pc 1,200 m 8,000 kg			Bla UGL Bla UGL	C491 (St pc)	

Dekorationselemente | éléments décoratifs | decoration elements

Mosaikfliese | carreau à mosaïques | mosaic tile

Feinsteinzeugfliesen unglasiert | grès cérame fin vitrifié non-émaillés | porcelain stoneware tiles unglazed

30 x 60 cm

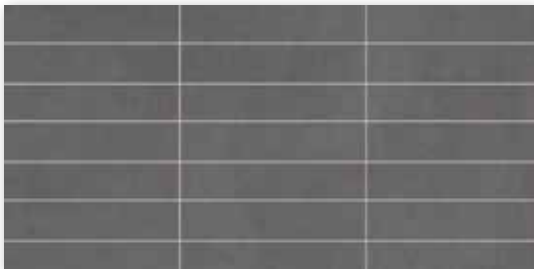

280351-73

Screen

anthrazit | anthracite

strukturiert, matt | structuré, mat | structured, matt

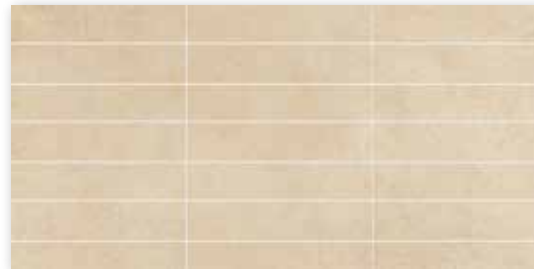

280362

Screen

sandbeige | beige sable | sand-beige

strukturiert, matt | structuré, mat | structured, matt



Farbabweichung zum Standard.

Les couleurs représentées peuvent différer du standard.

Colour deviation from the standard.

Abgabe der Dekorationselemente ausschließlich in vollen Kartons.
Éléments décoratifs uniquement livrables en cartons entiers.
Decoration elements only available in full boxes.

Art.	Nennmaß cote nominale nominal size cm	Herstellmaß cote de fabrication production size mm	m	Paket carton box	Palette palette pallet	Beanspr.-Gruppe groupe d'emploi wear resist. group	Norm Norme Standard	Trittsicherheit antidérapance non-slip	Preisgruppe groupe de prix price category
280350-73	8 x 60	80 x 597 x 10,5	1,667 St pc 1,779 kg	4 St pc 2,400 m 4,268 kg			Bla UGL Bla UGL	C447 (St pc)	
280361	8 x 60	80 x 595 x 10	1,667 St pc 1,779 kg	4 St pc 2,400 m 4,268 kg			Bla UGL Bla UGL	C447 (St pc)	

Dekorationselemente | éléments décoratifs | decoration elements

Bordüre | bordure | border

Feinsteinzeugfliesen unglasiert | grès cérame fin vitrifié non-émaillés | porcelain stoneware tiles unglazed

8 x 60 cm



280350-73

Stripes
anthrazit | anthracite
strukturiert, matt | structuré, mat | structured, matt

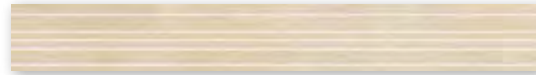

280361

Stripes
sandbeige | beige sable | sand-beige
strukturiert, matt | structuré, mat | structured, matt



Farbabweichung zum Standard.
Les couleurs représentées peuvent différer du standard.
Colour deviation from the standard.



Luxuriös und harmonisch

Ob in Kombination mit Naturmaterialien, Pastellfarben oder Metall: Evalia passt sich individuellen Wohnideen an und bringt eine geschmackvolle, luxuriöse Note ein. Zu den großformatigen R9-Bodenfliesen in Grau, Beige und Anthrazit harmonisieren die Wandfliesen in Graubeige matt oder glänzend. Ebenfalls in Graubeige: das Dekor Shino im Format 30 x 60 cm und das R10/B-Mosaik im Format 5 x 5 cm, die im gleichen Look & Feel der Serie für Dynamik in der Gestaltung sorgen. Wandfliesen, Dekor und Mosaik sind durch die Hytect-Oberfläche reinigungsfreundlich. Sockel runden das Fliesenprogramm ab.

Luxueux et harmonieux

Combiné facilement et libère des matériaux naturels, des couleurs pastel ou des métaux, Evalia s'adapte à toutes vos idées d'aménagement et leur apporte une touche de luxe raffiné. Les carreaux de sol R9 sont disponibles en gris, beige et anthracite. Également disponible en gris-beige : le décor Shino au format 30 x 60 cm et la mosaïque R10/B au format 5 x 5 cm, qui reprennent l'esprit de la série et permettent d'ajouter du dynamisme à votre agencement. Les carreaux muraux, décoratifs et mosaïques sont dotés de la finition Hytect, facile à nettoyer. Des plinthes viennent compléter cette gamme de carreaux.

Luxurious and harmonious

Whether in combination with natural materials, pastel colors or metal: Evalia adapts to individual home ideas and adds a tasteful, luxurious touch. The large-format R9 floor tiles in grey, beige and anthracite harmonize with the wall tiles in grey beige matt or gloss. Likewise in grey-beige: the Shino decorative element measuring 30 x 60 cm and R10/B mosaic in 5 x 5 cm whose similar look and feel inject some dynamism into the design. Wall tiles, decorations and mosaics are easy to clean thanks to the Hytect surface. This range of tiles is rounded off by skirtings.





Art.	Nennmaß cote nominale nominal size cm	Herstellmaß cote de fabrication production size mm	m ²	Paket carton box	Palette palette pallet	Beanspr.-Gruppe groupe d'emploi wear resist. group	Norm Norme Standard	Trittsicherheit antidérapance non-slip	Preisgruppe groupe de prix price category
283102HR	30 x 60	297 x 597 x 9	5,556 St pc	9 St pc	77,754 m ²		BIII GL		C140 (m ²)
283126HR			15,279 kg	1,620 m ² 24,750 kg	1.188,000 kg		BIII GL		C140 (m ²)
393104H	30 x 90	297 x 897 x 10,5	3,704 St pc	5 St pc	32,397 m ²		BIII GL		C179 (m ²)
393127H			17,976 kg	1,350 m ² 24,265 kg	582,360 kg		BIII GL		C179 (m ²)

Wandfliese | carreau de mur | wall tile
Steingut glasiert | faïence émaillée | earthenware glazed

30 x 60 cm

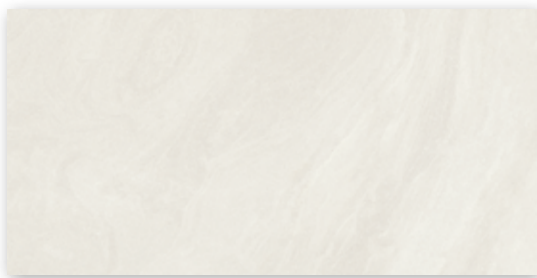

283102HR
graubeige | gris beige | grey beige
eben, glänzend | lisse, brillant | smooth, glossy

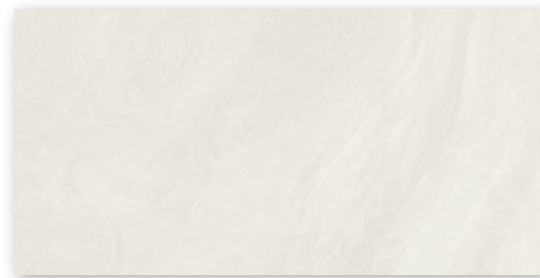

283126HR
graubeige | gris beige | grey beige
eben, seidenmatt | lisse, satinée | smooth, silky-matt



30 x 90 cm

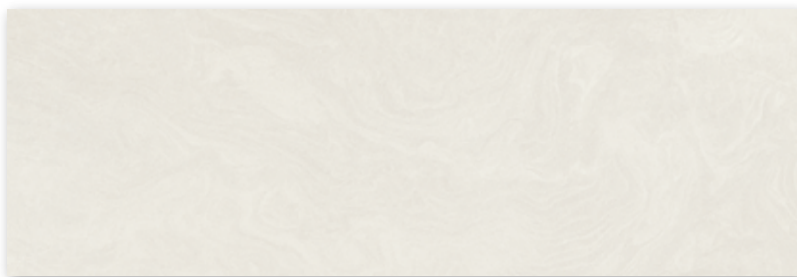

393104H
graubeige | gris beige | grey beige
eben, glänzend | lisse, brillant | smooth, glossy

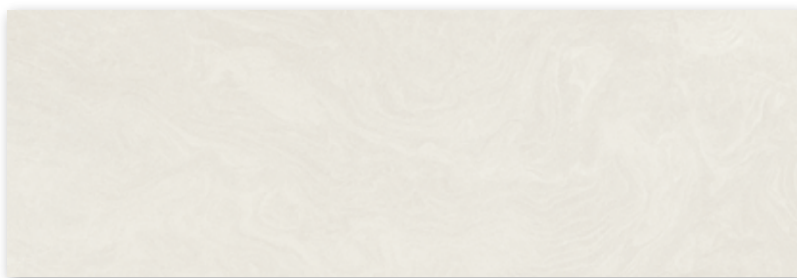
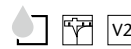

393127H
graubeige | gris beige | grey beige
eben, seidenmatt | lisse, satinée | smooth, silky-matt

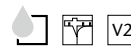

Art.	Nennmaß cote nominale nominal size cm	Herstellmaß cote de fabrication production size mm	m ²	Paket carton box	Palette palette pallet	Beanspr.-Gruppe groupe d'emploi wear resist. group	Norm Norme Standard	Trittsicherheit antidérapance non-slip	Preisgruppe groupe de prix price category
283103HR	30 x 60	297 x 597 x 9	5,556 St pc 15,279 kg	9 St pc 1,620 m ² 24,750 kg	77,754 m ² 1.188,000 kg		BIII GL		C146 (m ²)

Dekorationselemente | éléments décoratifs | decoration elements

Dekorfliese Shino | carreau décoratif Shino | decorative element Shino

Steingut glasiert | faïence émaillée | earthenware glazed

30 x 60 cm



283103HR

graubeige | gris beige | grey beige
eben, glänzend | lisse, brillant | smooth, glossy

Farbunterschiede sind möglich und Bestandteil des Designs. Bei der von Ihnen ausgewählten Dekoration handelt es sich um ein hochwertiges Produkt aus Steingut glasiert, das mit einer besonders realistischen Steinoptik überzeugt. Die Dekoration besteht aus unterschiedlichen Einzelbildern. Die Anschlüsse der Einzelbilder sind bewusst frei gestaltet, und verbinden sich somit nicht in der fortlaufenden Verlegung.

Les différences de teintes sont possibles et font partie du motif. L'élément de décoration que vous avez choisi est un produit en faïence émaillée de grande qualité qui convainc par un visuel de pierre particulièrement réaliste. Ce décor se compose de motifs individuels différents. Les raccords entre ces motifs individuels sont conçus librement et non pour être raccordés en une pose continue.

Color deviations are possible and represent a component of the design. The decoration you have chosen is a high-quality glazed earthenware product with a particularly impressive and realistic stone look. The decoration comprises various individual pictures, whose connections are consciously freely designed. Accordingly, individual tiles do not create a continuous design.

Abgabe der Dekorationselemente ausschließlich in vollen Kartons.
Éléments décoratifs uniquement livrables en cartons entiers.
Decoration elements only available in full boxes.

Art.	Nennmaß cote nominale nominal size cm	Herstellmaß cote de fabrication production size mm	m ²	Paket carton box	Palette palette pallet	Beanspr.-Gruppe groupe d'emploi wear resist. group	Norm Norme Standard	Trittsicherheit antidérapance non-slip	Preisgruppe groupe de prix price category
393105H	30 x 90	297 x 897 x 10,5	3,704 St pc 17,976 kg	5 St pc 1,350 m ² 24,265 kg	32,397 m ² 582,360 kg		BIII GL		C185 (m ²)

Dekorationselemente | éléments décoratifs | decoration elements

Dekorfliese Shino | carreau décoratif Shino | decorative element Shino

Steingut glasiert | faïence émaillée | earthenware glazed

30 x 90 cm



393105H

graubeige | gris beige | grey beige
eben, glänzend | lisse, brillant | smooth, glossy

Farbunterschiede sind möglich und Bestandteil des Designs. Bei der von Ihnen ausgewählten Dekoration handelt es sich um ein hochwertiges Produkt aus Steingut glasiert, das mit einer besonders realistischen Steinoptik überzeugt. Die Dekoration besteht aus unterschiedlichen Einzelbildern. Die Anschlüsse der Einzelbilder sind bewusst frei gestaltet, und verbinden sich somit nicht in der fortlaufenden Verlegung.

Les différences de teintes sont possibles et font partie du motif. L'élément de décoration que vous avez choisi est un produit en faïence émaillée de grande qualité qui convainc par un visuel de pierre particulièrement réaliste. Ce décor se compose de motifs individuels différents. Les raccords entre Ces motifs individuels sont conçus librement et non pour être raccordés en une pose continue.

Color deviations are possible and represent a component of the design. The decoration you have chosen is a high-quality glazed earthenware product with a particularly impressive and realistic stone look. The decoration comprises various individual pictures, whose connections are consciously freely designed. Accordingly, individual tiles do not create a continuous design.

Abgabe der Dekorationselemente ausschließlich in vollen Kartons.
Éléments décoratifs uniquement livrables en cartons entiers.
Decoration elements only available in full boxes.

Art.	Nennmaß cote nominale nominal size cm	Herstellmaß cote de fabrication production size mm	m ²	Paket carton box	Palette palette pallet	Beanspr.-Gruppe groupe d'emploi wear resist. group	Norm Norme Standard	Trittsicherheit antidérapance non-slip	Preisgruppe groupe de prix price category
431913							Bla UGL	R9	C164 (m ²)
431914	60 x 60	595 x 595 x 9,5	2,778 St pc	4 St pc	46,076 m ²		Bla UGL	R9	C164 (m ²)
431915			21,112 kg	1,440 m ² 30,400 kg	972,800 kg		Bla UGL	R9	C164 (m ²)
431916							Bla UGL	R9	C179 (m ²)
431917	45 x 90	446 x 895 x 9,5	2,470 St pc	3 St pc	36,437 m ²		Bla UGL	R9	C179 (m ²)
431918			23,465 kg	1,215 m ² 28,500 kg	855,000 kg		Bla UGL	R9	C179 (m ²)



grau
gris
grey

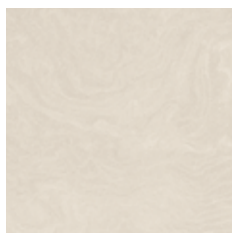

beige



anthrazit
anthracite



Bodenfliese | carreau de sol | floor tile

Feinsteinzeugfliesen unglasiert | grès cérame fin vitrifié non-émaillés | porcelain stoneware tiles unglazed

60 x 60 cm



431913

grau | gris | grey
eben, lappato | lisse, semi-poli | smooth, semi-polished

431914

beige
eben, lappato | lisse, semi-poli | smooth, semi-polished

431915

anthrazit | anthracite
eben, lappato | lisse, semi-poli | smooth, semi-polished

45 x 90 cm *



431916

grau | gris | grey
eben, lappato | lisse, semi-poli | smooth, semi-polished

431917

beige
eben, lappato | lisse, semi-poli | smooth, semi-polished

431918

anthrazit | anthracite
eben, lappato | lisse, semi-poli | smooth, semi-polished

* Achtung: Sonderpalette. Keine Rücknahme, kein Umtausch.

* Attention : palette spéciale. Pas de retour, pas d'échange.

* Please note: special pallet. No return, no exchange.

Art.	Nennmaß cote nominale nominal size cm	Herstellmaß cote de fabrication production size mm	m ² /m	Paket carton box	Palette palette pallet	Beanspr.-Gruppe groupe d'emploi wear resist. group	Norm Norme Standard	Trittsicherheit antidérapance non-slip	Preisgruppe groupe de prix price category
431920							Bla UGL		C440 (St pc)
431921	7 x 60	70 x 595 x 9,5	1,667 St pc / m	15 St pc			Bla UGL		C440 (St pc)
431922			1,470 kg	8,998 m 13,230 kg			Bla UGL		C440 (St pc)
431919H	5 x 5	47 x 47 x 6,5	11 Bögen plaques sheets 12,331 kg / m ²	11 Bögen plaques sheets 1,000 m ² 12,331 kg	64,000 m ² 789,184 kg		Bla UGL	R10/B	C230 (m ²)



grau
gris
grey

V3



beige

V3

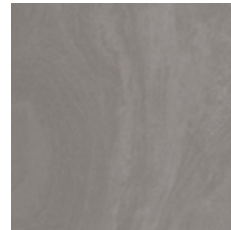

anthrazit
anthracite

V3

Sockel, gerundet | plinthe, arrondie | skirting, rounded

Feinsteinzeugfliesen unglasiert | grès cérame fin vitrifié non-émaillés | porcelain stoneware tiles unglazed

7 x 60 cm

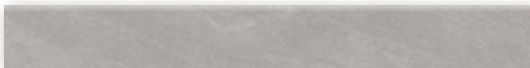

431920

grau | gris | grey
eben, lappato | lisse, semi-poli | smooth, semi-polishe

431921

beige
eben, lappato | lisse, semi-poli | smooth, semi-polishe

431922

anthrazit | anthracite
eben, lappato | lisse, semi-poli | smooth, semi-polishe

Mosaik | mosaïque | mosaic

Feinsteinzeugfliesen unglasiert | grès cérame fin vitrifié non-émaillés | porcelain stoneware tiles unglazed

5 x 5 cm



431919H

Shino
graubeige | gris beige | grey beige
eben, lappato | lisse, semi-poli | smooth, semi-polishe

Mosaik, rückseitig thermoplastisch verklebt

Bogen: 297 x 297 mm

Mosaïque, collage thermoplastique sur l'envers

Feuille: 297 x 297 mm

Mosaic, glued thermo-plastically on back

Sheet: 297 x 297 mm







Dezenter Luxus – kultiviertes Wohnen

Die gestreiften Wandfliesen in 30 x 60 cm oder 30 x 90 cm und die Dekorfliese Step in 30 x 90 cm, die die zarten Streifen der Wandfliese ausdrucksstärker aufgreift, vermitteln stilvolle Eleganz. Diese beiden Fliesen für die Wandgestaltung werden harmonisch ergänzt durch ein Mosaikdekor, geschnitten aus den Feinsteinzeug-Bodenfliesen und mit abwechselnd polierten und unpolierten Elementen. Erhältlich in den Farben Anthrazit-Schwarz, Hellbeige oder Mittelbraun.

Un luxe décent pour un intérieur raffiné

Les carreaux de mur subtilement rayés de format 30 x 60 cm et 30 x 90 et l'élément de décor Step de 30 x 90 cm qui reprend, en les intensifiant, les fines rayures du carreau de mur, laissent une impression d'élégance raffinée. L'élément de décor en mosaïque, découpé dans les carreaux de sol en gré cérame et alternant les surfaces polies et dépolies vient harmonieusement compléter les deux carreaux de mur. Couleurs disponibles : anthracite-noir, beige clair et brun moyen.

Discreet luxury for a stylish interior

Stylish elegance is conveyed by the striped wall tiles in 30 x 60 cm or 30 x 90 cm and the Step decorative tile in 30 x 90 cm which picks up on the delicate stripes of the wall tile in a more expressive manner. Both of these tiles for wall design are harmoniously supplemented by a mosaic décor cut from the porcelain stoneware floor tiles and featuring alternating polished and unpolished elements. Available in anthracite-black, light-beige or mid-brown.



Art.	Nennmaß cote nominale nominal size cm	Herstellmaß cote de fabrication production size mm	m ²	Paket carton box	Palette palette pallet	Beanspr.-Gruppe groupe d'emploi wear resist. group	Norm Norme Standard	Trittsicherheit antidérapance non-slip	Preisgruppe groupe de prix price category
280874H							BIII GL		W90 (m ²)
281140H	30 x 60	297 x 597 x 9	5,556 St pc	9 St pc	77,754 m ²		BIII GL		W90 (m ²)
282730H			14,946 kg	1,620 m ² 24,210 kg	1.162,080 kg		BIII GL		W90 (m ²)
392735H							BIII GL		W162 (m ²)
392736H	30 x 90	297 x 897 x 10,5	3,704 St pc	5 St pc	32,397 m ²		BIII GL		W162 (m ²)
392738H			17,976 kg	1,350 m ² 24,265 kg	582,360 kg		BIII GL		W162 (m ²)

Wandfliese | carreau de mur | wall tile
Steingut glasiert | faïence émaillée | earthenware glazed

30 x 60 cm

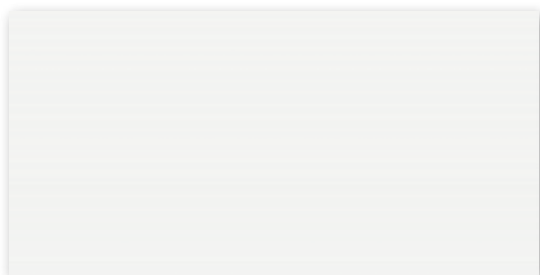

280874H
weiß | blanc | white
eben, glänzend | lisse, brillant | smooth, glossy

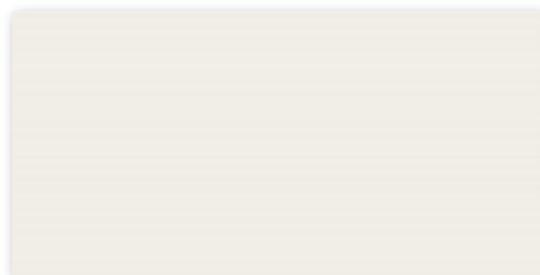

282730H
champagner | champagne | champagne
eben, glänzend | lisse, brillant | smooth, glossy



281140H
weiß | blanc | white
eben, seidenmatt | lisse, satiné | smooth, silky-mat

30 x 90 cm

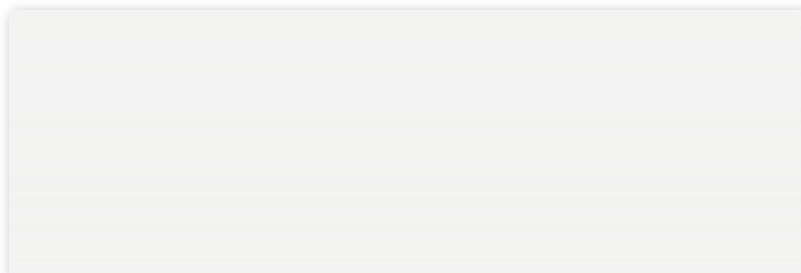

392735H
weiß | blanc | white
eben, glänzend | lisse, brillant | smooth, glossy

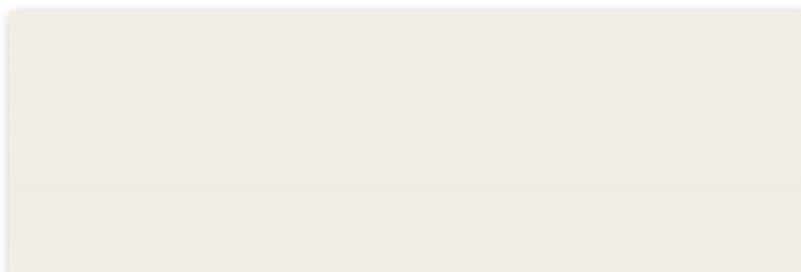

392736H
champagner | champagne | champagne
eben, glänzend | lisse, brillant | smooth, glossy

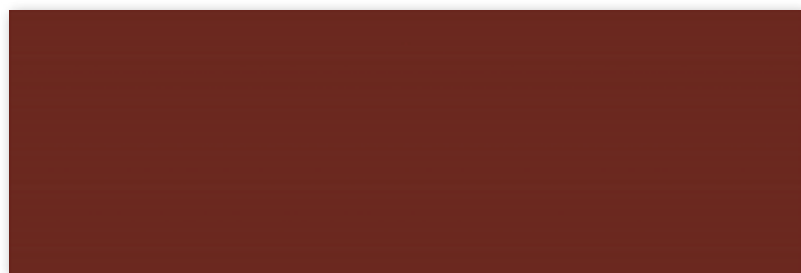

392738H
dunkelrot | rouge foncé | dark-red
eben, glänzend | lisse, brillant | smooth, glossy

Art.	Nennmaß cote nominale nominal size cm	Herstellmaß cote de fabrication production size mm	m	Paket carton box	Palette palette pallet	Beanspr.-Gruppe groupe d'emploi wear resist. group	Norm Norme Standard	Trittsicherheit antidérapance non-slip	Preisgruppe groupe de prix price category
282731							Bla UGL		W493 (St pc)
282733	30 x 30	297 x 297 x 10,5	3,333 St pc	3 St pc			Bla UGL		W493 (St pc)
282734			6,666 kg	0,900 m	6,000 kg		Bla UGL		W493 (St pc)

Dekorationselemente | éléments décoratifs | decoration elements

Mosaikmatte Step | mosaïque Step | mosaic sheet Step

Feinsteinzeugfliesen unglasiert | grès fin non-émaillés | porcelain stoneware tiles unglazed

30 x 30 cm

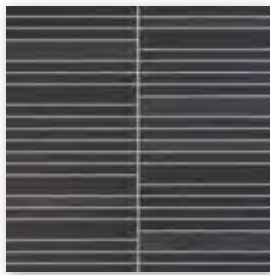

282731



anthrazit-schwarz
anthracite noir
anthracite-black
eben, teilpoliert
lisse, semi-polie
smooth, semi-polished

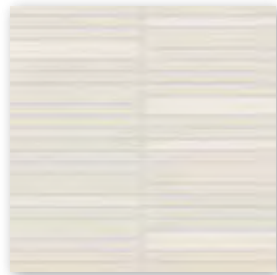

282733



hellbeige
beige clair
light-beige
eben, teilpoliert
lisse, semi-polie
smooth, semi-polished

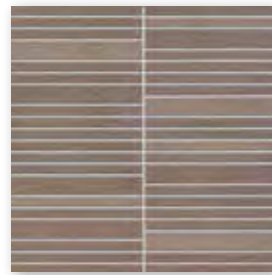

282734



mittelbraun
brun moyen
mid-brown
eben, teilpoliert
lisse, semi-polie
smooth, semi-polished

Mosaik, Verklebung rückseitig auf Glasfasernetz, Bogen: 297 x 297 mm. Nur für die Verlegung an der Wand geeignet.

Mosaïque, collée sur trame en fibre de verre à l'envers, Feuille: 297 x 297 mm. Convient uniquement pour une pose murale.

Mosaic, glass fibre net on reverse side, Sheet: 297 x 297 mm. Only suitable for laying on the wall.

Art.	Nennmaß cote nominale nominal size cm	Herstellmaß cote de fabrication production size mm	m ²	Paket carton box	Palette palette pallet	Beanspr.-Gruppe groupe d'emploi wear resist. group	Norm Norme Standard	Trittsicherheit antidérapance non-slip	Preisgruppe groupe de prix price category
392739H							BIII GL		W171 (m²)
392740H	30 x 90	297 x 897 x 10,5	3,704 St pc	5 St pc	32,397 m ²		BIII GL		W171 (m²)
392742H			17,976 kg	1,350 m ² 22,450 kg	582,360 kg		BIII GL		W171 (m²)

Dekorationselemente | éléments décoratifs | decoration elements

Dekorfliese Step | carreau décoratif Step | decorative element Step

Steingut glasiert | faïence émaillée | earthenware glazed

30 x 90 cm

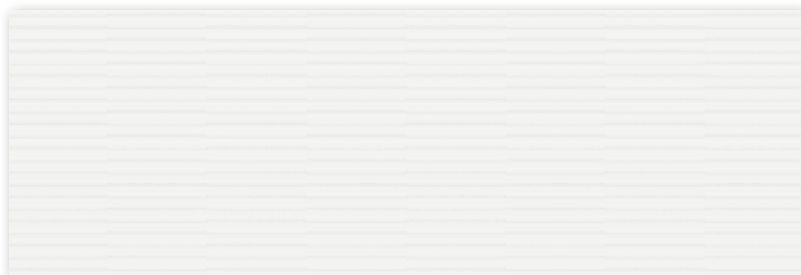

392739H

weiß | blanc | white
eben, glänzend | lisse, brillant | smooth, glossy

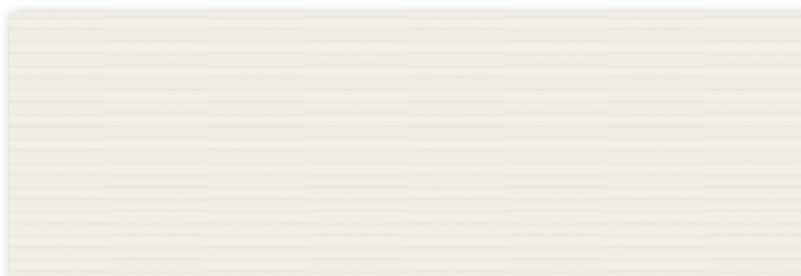

392740H

champagner | champagne | champagne
eben, glänzend | lisse, brillant | smooth, glossy



392742H

dunkelrot, | rouge foncé | dark-red
eben, glänzend | lisse, brillant | smooth, glossy







Abstrakte Schönheit genießen

Die Kollektion Jasba-CLARA interpretiert klassische ornamentale und geometrische Fliesenmuster modern und romantisch. Vintage-Fans lieben diese Fliesen. Auch, weil sie in ihren fünf zarten Ton-in-Ton Farben und mit ihren zwei Formaten ein sanftes und unverwechselbares Raumdesign schaffen. Klassische Musterungen in Reliefoptik treffen auf sanfte Cremefarben in Rosa und Blau, Grau und Grün. Wohlige Landhausatmosphäre liegt in der Luft. Und die schönsten Seiten des Vintage-Trends. Jasba-CLARA ist ein Hingucker in privaten Küchen, besonders kombiniert mit puristischen Wohnelementen. Im Essbereich entsteht sofort ein heimeliges Gefühl. In Bädern oder im Wellnessbereich ein Kokon der individuellen Geborgenheit. Speziell im Nassbereich, aber auch in Küchen spielt die Serie ihre Hytect Eigenschaften voll aus. Denn ihre Oberfläche wirkt antibakteriell, sie verhindert Schimmelbildung und sie ist besonders pflegeleicht.

Apprécier la beauté abstraite

La collection Jasba-CLARA interprète des motifs ornementaux et géométriques classiques des carreaux d'une manière moderne et romantique. Les amateurs de vintage adorent ces carreaux, aussi parce qu'avec leurs cinq couleurs délicates ton sur ton et leurs deux formats, ils créent une douce ambiance unique en son genre. Des motifs classiques en relief rencontrent des couleurs crème douces en rose et bleu, gris et vert. Il y règne une ambiance de maison de campagne chaleureuse, arrondie par les plus beaux éléments de la tendance vintage. Jasba-CLARA attire l'attention dans les cuisines privées, surtout lorsque la série est associée à des éléments d'habitation puristes. Un sentiment d'intimité est immédiatement créé dans le coin repas. Dans les salles de bains ou dans l'espace bien-être, on se sent dans un cocon de sécurité individuel. En particulier dans les zones mouillées, mais aussi dans les cuisines, la série met pleinement en valeur ses propriétés Hytect. Étant donné que sa surface a un effet antibactérien, elle empêche la formation de moisissures et est particulièrement facile à nettoyer.

Enjoying abstract beauty

The Jasba-CLARA collection interprets classic ornamental and geometric tile patterns in a modern and romantic way. Vintage fans love these tiles. Also because they create a soft and distinctive room design in their five delicate tone-in-tone colors and with their two formats. Classic patterns in relief look meet soft cream colors in pink and blue, grey and green. A cosy country house atmosphere is in the air. And the most beautiful sides of the vintage trend. Jasba-CLARA is an eye-catcher in private kitchens, especially when combined with puristic furniture. In the dining area, it immediately creates a homey feeling. In bathrooms or wellness areas, a cocoon of individual security. Especially in wet areas, but also in kitchens, the Hytect properties of the series come in useful. Its surface has an antibacterial effect, prevents the formation of mould and is particularly easy to clean.

Art.	Nennmaß cote nominale nominal size cm	Herstellmaß cote de fabrication production size mm	m ²	Paket carton box	Palette palette pallet	Beanspr.-Gruppe groupe d'emploi wear resist. group	Norm Norme Standard	Trittsicherheit antidérapance non-slip	Preisgruppe groupe de prix price category
432135H							Bla GL		W150 (m ²)
432136H	10 x 10	97 x 97 x 6,5	11,000 St pc	11 St pc	64,000 m ²		Bla GL		W150 (m ²)
432137H			13,101 kg	1,000 m ² 13,101 kg	838,464 kg		Bla GL		W150 (m ²)
432138H							Bla GL		W150 (m ²)
432139H							Bla GL		W150 (m ²)



country green



vintage rose



paris grey



iceland white

Mosaik | mosaïque | mosaic

Feinsteinzeugfliesen glasiert | grès cérame fin vitrifié émaillés | porcelain stoneware tiles glazed

10 x 10 cm



432135H



nordic blue,
strukturiert, glänzend
structuré, brillant
structured, glossy

432136H

country green,
strukturiert, glänzend
structuré, brillant
structured, glossy

432138H

paris grey,
strukturiert, glänzend
structuré, brillant
structured, glossy

432137H

vintage rose,
strukturiert, glänzend
structuré, brillant
structured, glossy

432139H

iceland white,
strukturiert, glänzend
structuré, brillant
structured, glossy

Mosaik, rückseitig thermoplastisch verklebt
Bogen: 297 x 297 mm
Mosaïque, collage thermoplastique sur l'envers
Feuille: 297 x 297 mm
Mosaic, glued thermo-plastically on back
Sheet: 297 x 297 mm

Die Artikel Jasba-CLARA bestehen jeweils aus unterschiedlichen Motiven. Die Anordnung und Konfektionierung erfolgt zufällig und willkürlich.

Les articles Jasba-CLARA arborent des motifs différents. Ces motifs sont agencés et confectionnés de manière aléatoire et fortuite.

The articles Jasba-CLARA each depict different motifs. Arrangement and packing are random and arbitrary.

Art.	Nennmaß cote nominale nominal size cm	Herstellmaß cote de fabrication production size mm	m ²	Paket carton box	Palette palette pallet	Beanspr.-Gruppe groupe d'emploi wear resist. group	Norm Norme Standard	Trittsicherheit antidérapance non-slip	Preisgruppe groupe de prix price category
432140H							Bla GL	W150 (m ²)	
432141H	15 x 15	147 x 147 x 6,5	44,444 St pc / m	44 St pc	79,201 m ²		Bla GL	W150 (m ²)	
432142H			13,955 kg	0,990 m ²	13,816 kg	1105,280 kg	Bla GL	W150 (m ²)	
432143H							Bla GL	W150 (m ²)	
432144H							Bla GL	W150 (m ²)	



country green



vintage rose



paris grey



iceland white

Wandfliese | Carreau de mur | Wall tile

Feinsteinzeugfliesen glasiert | grès cérame fin vitrifié émaillés | porcelain stoneware tiles glazed

15 x 15 cm



432140H   

nordic blue,
strukturiert, glänzend
structuré, brillant
structured, glossy

432141H

country green,
strukturiert, glänzend
structuré, brillant
structured, glossy

432143H

paris grey,
strukturiert, glänzend
structuré, brillant
structured, glossy

432142H

vintage rose,
strukturiert, glänzend
structuré, brillant
structured, glossy

432144H

iceland white,
strukturiert, glänzend
structuré, brillant
structured, glossy

Die Artikel Jasba-CLARA bestehen jeweils aus unterschiedlichen Motiven. Die Anordnung und Konfektionierung erfolgt zufällig und willkürlich.

Les articles Jasba-CLARA arborent des motifs différents. Ces motifs sont agencés et confectionnés de manière aléatoire et fortuite.

Bodenempfehlung Serie Walden (Seite 672), Serie Stories (Seite 652), Serie Like (Seite 568).
Recommandation relative au sol, série Walden (page 672), série Stories (page 652), série Like (page 568).
Recommended floor tiles: series Walden (page 672), series Stories (page 652), series Like (page 568).

The articles Jasba-CLARA each depict different motifs. Arrangement and packing are random and arbitrary.





Mit einem Hauch von Nostalgie

Ursprüngliches neu erleben. Motive spielerisch kombinieren, im Innen- wie im Außenbereich: Mit zusätzlichen Mustern und Einzeldekoren ist der „Vintage-Baukasten“ der erfolgreichen Serie Jasba-PATTERN umfangreich bestückt und fügt sich perfekt in jeden Wohnstil ein. Das Dekor Vanda bietet einen Mix aus 12 verschiedenen floralen und geometrischen Motiven. Als Einzelmotive bieten sich das florale Dekor Isola und das geometrische Dekor Baleno an. Alle drei Dekorvarianten harmonisieren durch ihre zarte Farbkombi- position mit der neuen Basisfliese in Zementgrau. Sie lassen sich aber auch zu vergrößerten Motiven aneinanderlegen – bis hin zum kerami- schen „Teppich“.

Avec une touche de nostalgie

Redécouvrir l'authenticité. Combiner des motifs de manière ludique, à l'intérieur comme à l'extérieur : Avec des motifs supplémentaires et des décors individuels, le « kit de construction vintage » de la série à succès Jasba-PATTERN est bien équipé et s'intègre parfaitement dans tous les styles d'habitat. L'élément de décor Vanda propose une palette de 12 motifs floraux et géométriques différents. Comme motifs individuels, le décor floral Isola et le décor géométrique que propose Baleno. Les trois variantes de décor s'harmonisent avec la nouvelle dalle de base en gris ciment grâce à leur composition chromatique délicate. Mais ils peuvent également être combinés pour créer des motifs agrandis, jusqu'au « tapis » en céramique.

With a breath of nostalgia

Experiencing original ideas anew, playfully combining motifs indoors and outdoors: with additional patterns and individual decorative elements, the “vintage modular system” of the successful series Jasba-PATTERN provides an extensive range of products and perfectly fits into any living style. The Vanda decorative element offers a mix of 12 different floral and geometric motifs. The floral Isola decorative element and the geometric Baleno decorative element are ideal as individual motifs. Thanks to their delicate color compositions, each of the three decorative variants harmonizes with the new basic tile in cement-grey. However, they can also be arranged to form larger motifs – or even a ceramic “carpet”.



Art.	Nennmaß cote nominale nominal size cm	Herstellmaß cote de fabrication production size mm	m ²	Paket carton box	Palette palette pallet	Beanspr.-Gruppe groupe d'emploi wear resist. group	Norm Norme Standard	Trittsicherheit antidérapance non-slip	Preisgruppe groupe de prix price category
42400H						3	Bib GL		W453 (St pc)
42401H	2,5 x 2,5	23 x 23 x 6,5	11 Bögen plaques sheets 12,100 kg	11 Bögen plaques sheets 1,000 m ² 12,160 kg	48,000 m ² 580,800 kg	3	Bib GL		W453 (St pc)
42402H						3	Bib GL		W453 (St pc)
42500H	5 x 5	47 x 47 x 6,5	11 Bögen plaques sheets 12,331 kg	11 Bögen plaques sheets 1,000 m ² 12,331 kg	64,000 m ² 789,184 kg	4	Bib GL	R10/B	W237 (m ²)
42501H						4	Bib GL	R10/B	W237 (m ²)

Mosaik | mosaïque | mosaic

Steinzeug glasiert | grès émaillé | stoneware glazed

2,5 x 2,5 cm



42400H

Vola
mehrfarbig, eben, seidenmatt
multicolore, lisse, satinée
multicolored, smooth, silky-matt



42401H

Vola
beige-braun, eben, seidenmatt
beige marron, lisse, satinée
beige-brown, smooth, silky-matt

Die Artikel Vola, Mesh, Salina und Vanda bestehen jeweils aus unterschiedlichen Motiven. Die Anordnung und Konfektionierung erfolgt zufällig und willkürlich.

Les articles Vola, Mesh, Salina et Vanda arborent des motifs différents. Ces motifs sont agencés et confectonnés de manière aléatoire et fortuite.

The articles Vola, Mesh, Salina and Vanda each depict different motifs. Arrangement and packing are random and arbitrary.

Mosaik, rückseitig thermoplastisch verklebt
Bogen: 297 x 297mm, ohne Außenfuge

Mosaïque, collage thermoplastique sur l'envers
Feuille: 297 x 297mm, sans joint extérieur

Mosaic, glued thermo-plastically on back
Sheet: 297 x 297mm, without external joint



42402H

Vola
grau, eben, seidenmatt
gris, lisse, satinée
grey, smooth, silky-matt



5 x 5 cm Secura



42500H

Vola
mehrfarbig, eben, seidenmatt
multicolore, lisse, satinée
multicolored, smooth, silky-matt



42501H

Vola
grau, eben, seidenmatt
gris, lisse, satinée
grey, smooth, silky-matt

Abgabe Mosaik 2,5 x 2,5 cm in vollen Kartons.
Mosaïques 2,5 x 2,5 cm uniquement livrables en cartons entiers.
Mosaics 2.5 x 2.5 cm only available in full boxes.

Art.	Nennmaß cote nominale nominal size cm	Herstellmaß cote de fabrication production size mm	m ²	Paket carton box	Palette palette pallet	Beanspr.-Gruppe groupe d'emploi wear resist. group	Norm Norme Standard	Trittsicherheit antidérapance non-slip	Preisgruppe groupe de prix price category
42010H						4	Bib GL		W150 (m ²)
42020H						4	Bib GL		W150 (m ²)
42000H	10 x 10	97 x 97 x 6,5	11 Bögen plaques sheets	11 Bögen plaques sheets	64,000 m ²	4	Bib GL		W117 (m ²)
42001H			13,101 kg	1,000 m ² 13,101 kg	838,464 kg	4	Bib GL		W117 (m ²)
42002H						4	Bib GL		W117 (m ²)

Mosaik | mosaïque | mosaic

Steinzeug glasiert | grès émaillé | stoneware glazed

10 x 10 cm



42010H

Mesh

Natur-mix, eben, seidenmatt
mélange nature, lisse, satinée
natural-mix, smooth, silky-matt



42020H

Vola

mehrfarbig, eben, seidenmatt
multicolore, lisse, satinée
multicolored, smooth, silky-matt



42000H

weiß, eben, seidenmatt
white, lisse, satinée
white, smooth, silky-matt



42001H

beige, eben, seidenmatt
beige, lisse, satinée
beige, smooth, silky-matt



42002H

grau, eben, seidenmatt
gris, lisse, satinée
grey, smooth, silky-matt

Mosaik, rückseitig thermoplastisch verklebt
Bogen: 297 x 297 mm

Mosaïque, collage thermoplastique sur l'envers
Feuille: 297 x 297 mm

Mosaic, glued thermo-plastically on back
Sheet: 297 x 297 mm

Die Artikel Vola, Mesh, Salina und Vanda bestehen jeweils aus unterschiedlichen Motiven. Die Anordnung und Konfektionierung erfolgt zufällig und willkürlich.

Les articles Vola, Mesh, Salina et Vanda arborent des motifs différents. Ces motifs sont agencés et confectionnés de manière aléatoire et fortuite.

The articles Vola, Mesh, Salina and Vanda each depict different motifs. Arrangement and packing are random and arbitrary.

Art.	Nennmaß cote nominale nominal size cm	Herstellmaß cote de fabrication production size mm	m ²	Paket carton box	Palette palette pallet	Beanspr.-Gruppe groupe d'emploi wear resist. group	Norm Norme Standard	Trittsicherheit antidérapance non-slip	Preisgruppe groupe de prix price category
42120H	20 x 20	197 x 197 x 6,5	25 St pc	25 St pc	72,000 m ²	4	Bib GL		W150 (m ²)
42121H			13,875 kg	1,000 m ² 13,875 kg	999,000 kg	4	Bib GL		W150 (m ²)

Wand- und Bodenfliese | Carreau de mur et de sol | Wall and floor tile
Steinzeug glasiert | grès émaillé | stoneware glazed

20 x 20 cm



42120H

Vola
mehrfarbig, eben, seidenmatt
multicolore, lisse, satinée
multicolored, smooth, silky-matt



42121H

Vola
grau, eben, seidenmatt
gris, lisse, satinée
grey, smooth, silky-matt

Die Artikel Vola, Mesh, Salina und Vanda bestehen jeweils aus unterschiedlichen Motiven. Die Anordnung und Konfektionierung erfolgt zufällig und willkürlich.

Les articles Vola, Mesh, Salina et Vanda arborent des motifs différents. Ces motifs sont agencés et confectionnés de manière aléatoire et fortuite.



The articles Vola, Mesh, Salina and Vanda each depict different motifs. Arrangement and packing are random and arbitrary.

Art.	Nennmaß cote nominale nominal size cm	Herstellmaß cote de fabrication production size mm	m ²	Paket carton box	Palette palette pallet	Beanspr.-Gruppe groupe d'emploi wear resist. group	Norm Norme Standard	Trittsicherheit antidérapance non-slip	Preisgruppe groupe de prix price category
42130H						4	Bib GL		W150 (m ²)
44400H	20 x 20	197 x 197 x 6,5	25 St pc	25 St pc	72,000 m ²	4	Bib GL		W150 (m ²)
44401H			13,875 kg	1,000 m ² 13,875 kg	999,000 kg	4	Bib GL		W150 (m ²)

Wand- und Bodenfliese | Carreau de mur et de sol | Wall and floor tile
Steinzeug glasiert | grès émaillé | stoneware glazed

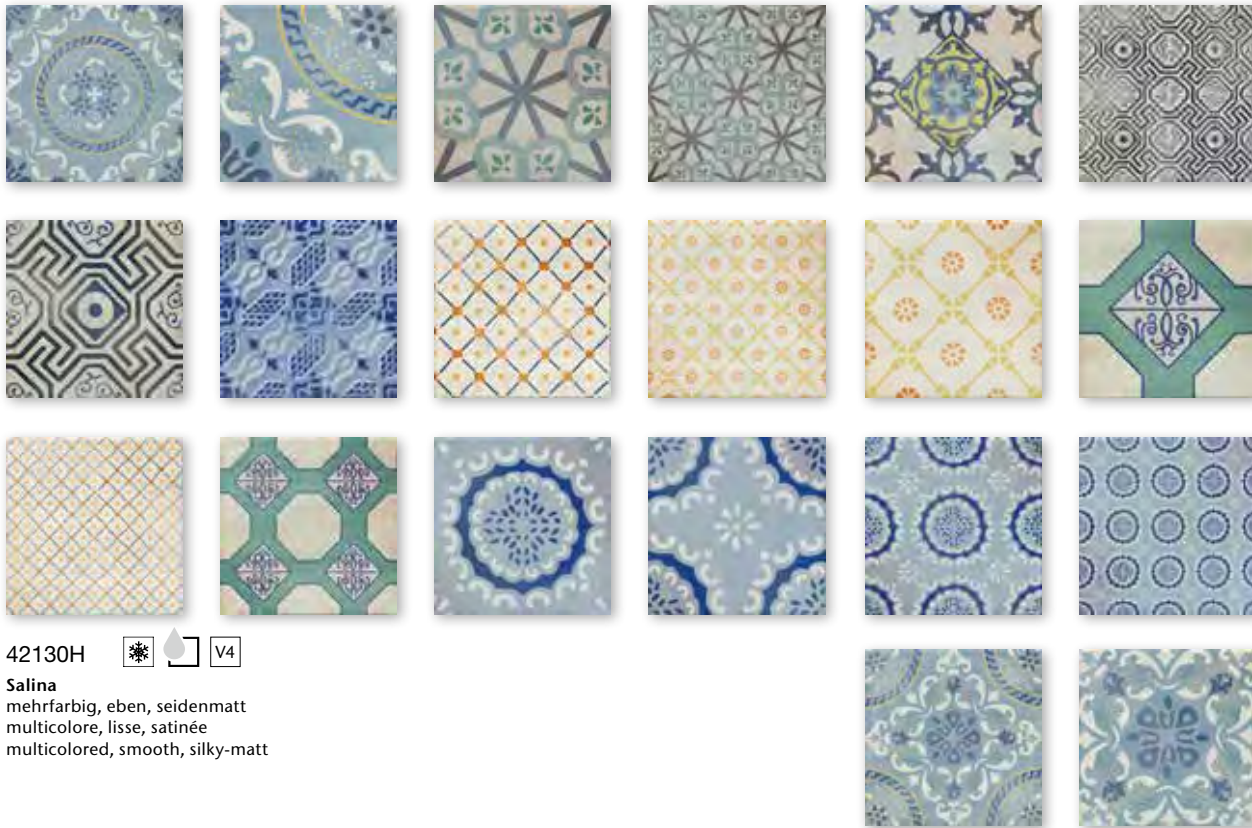

20 x 20 cm





42130H   
Salina
 mehrfarbig, eben, seidenmatt
 multicolore, lisse, satinée
 multicolored, smooth, silky-matt

Einzel motive | Motifs individuels | Individual motifs



44400H   
Nelas
 schwarz-weiß, eben, seidenmatt
 noir-blanc, lisse, satinée
 black-white, smooth, silky-matt

44401H   
Mellby
 grau, eben, seidenmatt
 gris, lisse, satinée
 grey, smooth, silky-matt

Die Artikel Vola, Mesh, Salina und Vanda bestehen jeweils aus unterschiedlichen Motiven. Die Anordnung und Konfektionierung erfolgt zufällig und willkürlich.

Les articles Vola, Mesh, Salina et Vanda arborent des motifs différents. Ces motifs sont agencés et confectionnés de manière aléatoire et fortuite.

The articles Vola, Mesh, Salina and Vanda each depict different motifs. Arrangement and packing are random and arbitrary.



Art.	Nennmaß cote nominale nominal size cm	Herstellmaß cote de fabrication production size mm	m ²	Paket carton box	Palette palette pallet	Beanspr.-Gruppe groupe d'emploi wear resist. group	Norm Norme Standard	Trittsicherheit antidérapance non-slip	Preisgruppe groupe de prix price category
42100H						4	Bib GL		W117 (m ²)
42101H	20 x 20	197 x 197 x 6,5	25 St pc	25 St pc	72,000 m ²	4	Bib GL		W117 (m ²)
42102H			13,875 kg	1,000 m ² 13,875 kg	999,000 kg	4	Bib GL		W117 (m ²)
42103H						3	Bib GL		W117 (m ²)
44425H							Bla UGL	R10/B	W117 (m ²)

Wand- und Bodenfliese | Carreau de mur et de sol | Wall and floor tile



Steinzeug glasiert | grès émaillé | stoneware glazed

20 x 20 cm





42100H   
weiß, eben, seidenmatt
blanc, mat satiné, lisse
white, smooth, silky-matt





42101H   
beige, eben, seidenmatt
beige, mat satiné, lisse
beige, smooth, silky-matt

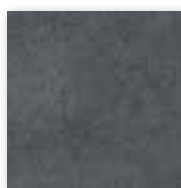

42102H   
grau, eben, seidenmatt
gris, mat satiné, lisse
grey, smooth, silky-matt





42103H   
anthrazit, eben, seidenmatt
anthracite, mat satiné, lisse
anthracite, smooth, silky-matt

Feinsteinzeug unglasiert | grès cérame fin non émaillé | porcelain stoneware unglazed

20 x 20 cm Secura



44425H   
cementgrau, eben, seidenmatt
cement gris, mat satiné, lisse
cement grey, smooth, silky-matt

Art.	Nennmaß cote nominale nominal size cm	Herstellmaß cote de fabrication production size mm	m ²	Paket carton box	Palette palette pallet	Beanspr.-Gruppe groupe d'emploi wear resist. group	Norm Norme Standard	Trittsicherheit antidérapance non-slip	Preisgruppe groupe de prix price category
44447H							Bla UGL	R10/B	W150 (m ²)
44448H	20 x 20	197 x 197 x 6,5	25 St pc	25 St pc	72,000 m ²		Bla UGL	R10/B	W150 (m ²)
44449H			13,875 kg	1,000 m ² 13,875 kg	999,000 kg		Bla UGL	R10/B	W150 (m ²)

Wand- und Bodenfliese | Carreau de mur et de sol | Wall and floor tile

Feinsteinzeug unglasiert | grès cérame fin non émaillé | porcelain stoneware unglazed

20 x 20 cm Secura



44449H

Vanda
mehrfarbig, eben, seidenmatt
multicolore, lisse, satinée
multicolored, smooth, silky-matt

Einzelmotive | Motifs individuels | Individual motifs

20 x 20 cm Secura



44447H

Baleno
mehrfarbig, eben, seidenmatt
multicolore, lisse, satinée
multicolored, smooth, silky-matt

44448H

Isola
mehrfarbig, eben, seidenmatt
multicolore, lisse, satinée
multicolored, smooth, silky-matt

Die Artikel Vola, Mesh, Salina und Vanda bestehen jeweils aus unterschiedlichen Motiven.
Die Anordnung und Konfektionierung erfolgt zufällig und willkürlich.

Les articles Vola, Mesh, Salina et Vanda arborent des motifs différents.
Ces motifs sont agencés et confectionnés de manière aléatoire et fortuite.

The articles Vola, Mesh, Salina and Vanda each depict different motifs.
Arrangement and packing are random and arbitrary.





Mal luxuriös, mal lässig – immer besonders

Jasba-RONDA ist das Ergebnis einer raffinierten Kombination verschiedenster Design- und Stilmittel: Patina-Glasuren, gitterartige Einschlüsse, historische Muster und bewusste Auslassungen. Die zwei Farben Cement Mix und Rost Mix unterstützen den Effekt einer korrodierten, „gelebten“ Oberfläche. Als Formate stehen Mosaik mit 2,5 x 2,5 cm und 5 x 5 cm, sowie ein trittsicheres 5 x 5 cm-Mosaik (R10/B) zur Verfügung. Alle Fliesen von Jasba-RONDA haben eine reinigungsfreundliche Hytect-Oberfläche.

Tantôt luxueux, tantôt nonchalant – toujours exceptionnel

Jasba-RONDA est né d'une combinaison subtile entre différents éléments de design et de style : vernis patiné, inserts grillagés, motifs historiques et omissions volontaires. Les deux teintes mélange ciment et mélange rouille renforce l'impression d'une surface corrodée qui a « vécu ». Le format mosaïque de 2,5 x 2,5 cm et 5 x 5 cm, et une mosaïque antidérapante de 5 x 5 cm (R10/B) sont disponibles dans la gamme. Tous les carreaux de Jasba-RONDA ont une surface Hytect facile à nettoyer.

Sometimes luxurious, sometimes casual – always special

Jasba-RONDA is the result of a sophisticated combination of various design and stylistic devices: patina glazes, mesh-like inclusions, historic patterns and intentional omissions. The two colors cement-mix and rust-mix support the effect of a corroded, "lively" surface finish. Available as mosaics in 2.5 x 2.5 cm and 5 x 5 cm and non-slip 5 x 5 cm mosaic (R10/B). All Jasba-RONDA tiles have an easy-clean Hytect surface.

Art.	Nennmaß cote nominale nominal size cm	Herstellmaß cote de fabrication production size mm	m ²	Paket carton box	Palette palette pallet	Beanspr.-Gruppe groupe d'emploi wear resist. group	Norm Norme Standard	Trittsicherheit antidérapance non-slip	Preisgruppe groupe de prix price category
43100H	2,5 x 2,5	23 x 23 x 6,5	11 Bögen plaques sheets 12,100 kg	11 Bögen plaques sheets 1,000 m ² 12,100 kg	48,000 m ² 580,800 kg	3 4	Bib GL Bib GL		W448 (St pc) W448 (St pc)
43200H	5 x 5	47 x 47 x 6,5	11 Bögen plaques sheets 12,331 kg	11 Bögen plaques sheets 1,000 m ² 12,331 kg	64,000 m ² 789,184 kg	3 4	Bib GL Bib GL		W222 (m ²) W222 (m ²)

Mosaik | mosaïque | mosaic

Steinzeug glasiert | grès émaillé | stoneware glazed

2,5 x 2,5 cm

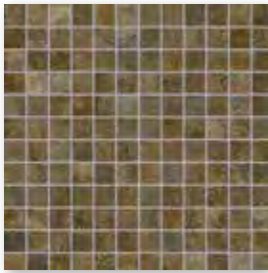

43100H
rost-mix, eben, matt
mélange rouille, lisse, mat
rust-mix, smooth, matt

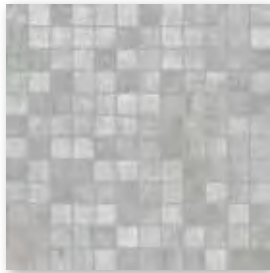

43101H
zement-mix, eben, matt
mélange coement, lisse, mat
cement-mix, smooth, matt

5 x 5 cm

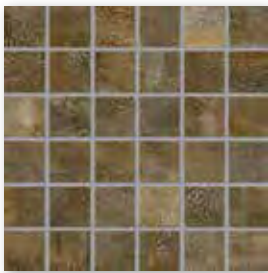

43200H
rost-mix, eben, matt
mélange rouille, lisse, mat
rust-mix, smooth, matt



43201H
zement-mix, eben, matt
mélange coement, lisse, mat
cement-mix, smooth, matt

Das von Ihnen gewählte Design variiert bewusst in der Farbigkeit. Dies gehört zur Charakteristik des Produktes.

Les variations de couleur du motif que vous avez sélectionné sont voulues. Ces variations font partie des caractéristiques.

The design you have chosen varies in color. This is inherent to the product.

Mosaik, rückseitig thermoplastisch verklebt
Bogen: 297 x 297 mm

Mosaïque, collage thermoplastique sur l'envers
Feuille: 297 x 297 mm

Mosaic, glued thermo-plastically on back
Sheet: 297 x 297 mm

Abgabe Mosaik 2,5 x 2,5 cm in vollen Kartons.
Mosaïques 2,5 x 2,5 cm uniquement livrables en cartons entiers.
Mosaics 2.5 x 2.5 cm only available in full boxes.





Art.	Nennmaß cote nominale nominal size cm	Herstellmaß cote de fabrication production size mm	m ²	Paket carton box	Palette palette pallet	Beanspr.-Gruppe groupe d'emploi wear resist. group	Norm Norme Standard	Trittsicherheit antidérapance non-slip	Preisgruppe groupe de prix price category
43225H	5 x 5	47 x 47 x 6,5	11 Bögen plaques sheets	11 Bögen plaques sheets	64,000 m ²	3	Bib GL	R10/B	W240 (m ²)
43226H			12,331 kg	1,000 m ² 12,331 kg	789,184 kg	4	Bib GL	R10/B	W240 (m ²)



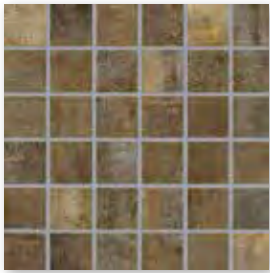

Mosaik | mosaïque | mosaic

Steinzeug glasiert | grès émaillé | stoneware glazed

5 x 5 cm Secura



43225H    
 rost-mix, eben, matt
 mélange rouille, lisse, mat
 rust-mix, smooth, matt

43226H    
 zement-mix, eben, matt
 mélange coement, lisse, mat
 cement-mix, smooth, matt

Mosaik, rückseitig thermoplastisch verklebt
 Bogen: 297 x 297 mm

Mosaïque, collage thermoplastique sur l'envers
 Feuille: 297 x 297 mm

Mosaic, glued thermo-plastically on back
 Sheet: 297 x 297 mm

Das von Ihnen gewählte Design variiert bewusst in der Farbigkeit. Dies gehört zur Charakteristik des Produktes.

Les variations de couleur du motif que vous avez sélectionné sont voulues. Ces variations font partie des caractéristiques.

The design you have chosen varies in color. This is inherent to the product.

Zeitgeist meets zeitlos

Die Keramikfliesen-Serie Jasba-SENJA PURE gibt Bädern und privaten Wellnessbereichen einen wohnlichen Touch und eine warme, lebendige Anmutung. Ihre naturnahen Farbtöne und sanft strukturierten Oberflächen sind trendy und gleichzeitig zeitlos schön. Das Ergebnis: Harmonisch aufeinander abgestimmte Räume im klaren Vintage Style, im wohltuend zurückhaltenden Nordic Design oder im Shabby-Chic-Style. Die erfolgreiche Kollektion wurde jetzt um die kräftige Farbe Shabby-Chic-Brown und um großformatige naturweiße Wandfliesen erweitert – das bietet noch mehr Spielraum für Gestaltung. Bodenfliesen gibt es mit trittsicherer Oberfläche und die Jasba-SENJA PURE sind dank Hytect Oberfläche pflegeleicht und sie wirken hygienisch.

Le Zeitgeist rencontre l'intemporel

La série de carreaux céramiques Jasba-SENJA PURE confère aux salles de bains et aux espaces de bien-être privés une touche de confort et une atmosphère chaleureuse et vivante. Leurs coloris naturels et leurs surfaces doucement structurées sont à la fois tendance et d'une beauté intemporelle. Le résultat : des pièces harmonieusement coordonnées dans un style vintage clair, dans un design nordique apaisant et sobre ou dans un style shabby chic. La collection à succès a maintenant été étendue pour inclure la couleur audacieuse Shabby Chic Brown et des carreaux muraux blancs naturels de grand format – offrant encore plus de possibilités de conception. Les carreaux de sol sont disponibles avec une surface antidérapante et les Jasba-SENJA PURE sont faciles à nettoyer tout en ayant un effet hygiénique grâce à la surface Hytect.

Zeitgeist meets timeless

The Jasba-SENJA PURE ceramic tile series gives bathrooms and private wellness areas a cosy touch and a warm, lively impression. Its natural colors and finely structured surfaces are trendy and at the same time timeless beautiful. The result: rooms harmoniously matched to one another in clear vintage style, in pleasantly restrained Nordic Design or in Shabby-Chic-Style. The successful collection has now been extended to include the strong color Shabby-Chic-Brown and large-size natural-white wall tiles – thus offering even more scope for design. Floor tiles are available with a slip-resistant surface, and Jasba-SENJA PURE is easy to clean thanks to its Hytect surface, which makes it hygienic.





Art.	Nennmaß cote nominale nominal size cm	Herstellmaß cote de fabrication production size mm	m ²	Paket carton box	Palette palette pallet	Beanspr.-Gruppe groupe d'emploi wear resist. group	Norm Norme Standard	Trittsicherheit antidérapance non-slip	Preisgruppe groupe de prix price category
3221H						4	B1b GL		W448 (St pc)
3222H						3	B1b GL		W448 (St pc)
3227	2,5 x 2,5	23 x 23 x 6,5	11 Bögen plaques sheets	11 Bögen plaques sheets	48,000 m ²	2	B1b GL		W462 (St pc)
3228H			12,100 kg	1,000 m ² 12,100 kg	580,800 kg	2	B1b GL		W448 (St pc)
3303H						4	B1b GL		W448 (St pc)
3304H						4	B1b GL		W448 (St pc)
3305H						4	B1b GL		W453 (St pc)
3306						1	B1b GL		W462 (St pc)

Mosaik | mosaïque | mosaic

Steinzeug glasiert | grès émaillé | stoneware glazed

2,5 x 2,5 cm



3221H
 ahorn | érable | maple
 strukturiert, matt | structuré, mat
 mat | structured, matt

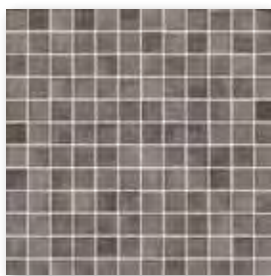

3222H
 shabby chic brown
 strukturiert, matt | structuré, mat
 structured, matt

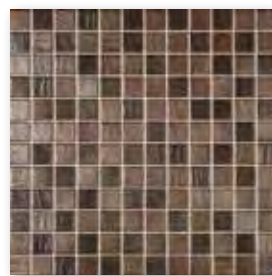

3227
 wenge-metallic | wengé-métallique
 strukturiert, matt | structuré, mat
 structured, matt

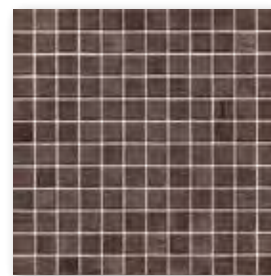

3228H
 wenge | wengé
 strukturiert, matt | structuré, mat
 mat | structured, matt



3303H
 eiche | chêne | oak
 strukturiert, matt | structuré, mat
 mat | structured, matt



3304H
 shabby chic
 strukturiert, matt | structuré, mat
 structured, matt



3305H
 wood-mix | mélange bois
 strukturiert, matt | structuré, mat
 structured, matt



3306
 wood-mix metallic | mélange bois métallisé
 strukturiert, matt | structuré, mat
 structured, matt

Mosaik, rückseitig thermoplastisch verklebt
 Bogen: 297 x 297 mm.

Mosaïque, collage thermoplastique
 sur l'envers Feuille: 297 x 297 mm.

Mosaic, glued thermo-plastically on back
 Sheet: 297 x 297 mm.

Abgabe Mosaik
 2,5 x 2,5 cm in vollen Kartons.

Mosaïques 2,5 x 2,5 cm
 uniquement livrables en cartons entiers.

Mosaics 2.5 x 2.5 cm
 only available in full boxes.

Art.	Nennmaß cote nominale nominal size cm	Herstellmaß cote de fabrication production size mm	m ²	Paket carton box	Palette palette pallet	Beanspr.-Gruppe groupe d'emploi wear resist. group	Norm Norme Standard	Trittsicherheit antidérapance non-slip	Preisgruppe groupe de prix price category
3201H						4	Bib GL	R10/B	W453 (St pc)
3202H						2	Bib GL	R10/B	W453 (St pc)
3203H	2,5 x 2,5	23 x 23 x 6,5	11 Bögen plaques sheets	11 Bögen plaques sheets	48,000 m ²	4	Bib GL	R10/B	W453 (St pc)
3206H			12,100 kg	1,000 m ² 12,100 kg	580,800 kg	3	Bib GL	R10/B	W453 (St pc)
3314H						4	Bib GL	R10/B	W453 (St pc)

Mosaik | mosaïque | mosaic

Steinzeug glasiert | grès émaillé | stoneware glazed

2,5 x 2,5 cm Secura





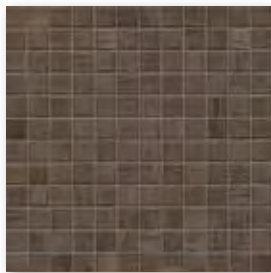

3201H    
 ahorn | érable | maple
 strukturiert, matt | structuré, mat |
 structured, matt



3202H    
 wenge | wengé
 strukturiert, matt | structuré, mat |
 structured, matt



3203H    
 eiche | chêne | oak
 strukturiert, matt | structuré, mat |
 structured, matt

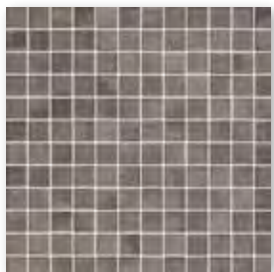

3206H    
 shabby chic brown
 strukturiert, matt | structuré, mat |
 structured, matt



3314H    
 shabby chic
 strukturiert, matt | structuré, mat |
 structured, matt

Mosaik, rückseitig thermoplastisch verklebt
 Bogen: 297 x 297 mm.

Mosaïque, collage thermoplastique
 sur l'envers Feuille: 297 x 297 mm.

Mosaic, glued thermo-plastically on back
 Sheet: 297 x 297 mm.

Abgabe Mosaik
 2,5 x 2,5 cm in vollen Kartons.

Mosaïques 2,5 x 2,5 cm
 uniquement livrables en cartons entiers.

Mosaics 2.5 x 2.5 cm
 only available in full boxes.

Art.	Nennmaß cote nominale nominal size cm	Herstellmaß cote de fabrication production size mm	m ²	Paket carton box	Palette palette pallet	Beanspr.-Gruppe groupe d'emploi wear resist. group	Norm Norme Standard	Trittsicherheit antidérapance non-slip	Preisgruppe groupe de prix price category
3251H						4	Bib GL	R10/B	W240 (m ²)
3252H	5 x 5	47 x 47 x 6,5	11 Bögen plaques sheets	11 Bögen plaques sheets	64,000 m ²	3	Bib GL	R10/B	W240 (m ²)
3258H			12,331 kg	1,000 m ² 12,331 kg	789,184 kg	2	Bib GL	R10/B	W240 (m ²)
3353H						4	Bib GL	R10/B	W240 (m ²)
3354H						4	Bib GL	R10/B	W240 (m ²)

Mosaik | mosaïque | mosaic

Steinzeug glasiert | grès émaillé | stoneware glazed

5 x 5 cm Secura

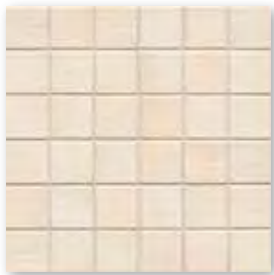

3251H
 ahorn | érable | maple
 strukturiert, matt | structuré, mat |
 structured, matt



3252H
 shabby chic brown
 strukturiert, matt | structuré, mat |
 structured, matt

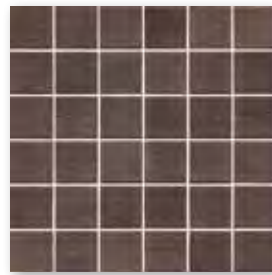

3258H
 wenge | wengé
 strukturiert, matt | structuré, mat |
 structured, matt



3353H
 eiche | chêne | oak
 strukturiert, matt | structuré, mat |
 structured, matt



3354H
 shabby chic
 strukturiert, matt | structuré, mat |
 structured, matt

Mosaik, rückseitig thermoplastisch verklebt
 Bogen: 297 x 297 mm, ohne Außenfuge

Mosaïque, collage thermoplastique
 sur l'envers Feuille: 297 x 297 mm, sans joint extérieur

Mosaic, glued thermo-plastically on back
 Sheet: 297 x 297 mm, without external joint

Art.	Nennmaß cote nominale nominal size cm	Herstellmaß cote de fabrication production size mm	m ²	Paket carton box	Palette palette pallet	Beanspr.-Gruppe groupe d'emploi wear resist. group	Norm Norme Standard	Trittsicherheit antidérapance non-slip	Preisgruppe groupe de prix price category
23330H	20 x 60	197 x 597 x 9	8,333 St pc 15,516 kg	8 St pc 0,960 m ² 14,896 kg	61,442 m ² 953,344 kg		BIII GL	W111 (m ²)	
203331H	30 x 60	297 x 597 x 6	5,556 St pc 10,279 kg	13 St pc 2,340 m ² 24,050 kg	112,311m ² 1.154,400 kg		BIII GL	W90 (m ²)	
323332H	30 x 90	297 x 897 x 6	3,704 St pc 10,400 kg	8 St pc 2,160 m ² 22,464 kg	51,836 m ² 539,136 kg		BIII GL	W111 (m ²)	

Wandfliese | carreau de mur | wall tile
Steingut glasiert | faïence émaillée | earthenware glazed

20 x 60 cm



23330H

pergamentweiß | blanc parchemin | parchment white
eben, seidenmatt | lisse, satinée | smooth, silky-matt



Wandfliese | carreau de mur | wall tile
Steinzeug glasiert | grès émaillé | stoneware glazed

30 x 60 cm



203331H *

naturweiß | blanc nature | natural-white
eben, seidenmatt | lisse, satinée | smooth, silky-matt



30 x 90 cm

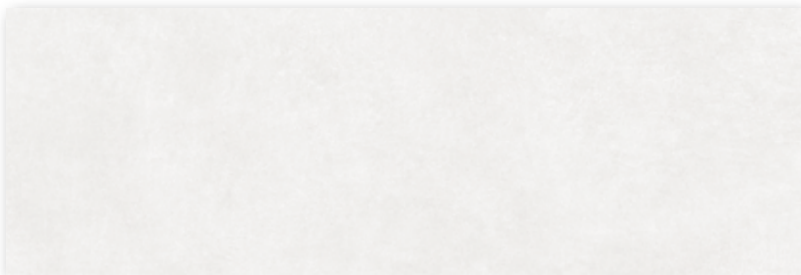

323332H *

naturweiß | blanc nature | natural-white
eben, seidenmatt | lisse, satinée | smooth, silky-matt



* Design & Farbe im Format 20 x 60 cm unterscheiden sich von den Formaten 30 x 60 cm und 30 x 90 cm.
* Le design et la couleur du format 20 x 60 cm diffèrent de ceux des formats 30 x 60 cm et 30 x 90 cm.
* The design and colour in the format of 20 x 60 cm differ from the formats of 30 x 60 cm and 30 x 90 cm.





Schiefer als Dekoelement?

Die Jasba-VILLAGE Kollektion mit ihrem reizvollen Schieferrelief macht dies möglich und spricht dabei nicht nur Auge sondern auch Tastsinn an. Ruhige Farben schaffen in Kombination mit der Schieferoptik eine warme, einladende Atmosphäre.

L'ardoise comme élément décoratif ?

La collection Jasba-VILLAGE le permet, avec son charmant relief en ardoise, qui non seulement tape à l'œil mais aussi réveille le sens du toucher. Les couleurs calmes associées à l'aspect ardoise créent une atmosphère chaleureuse et accueillante.

Slate as a decorative element?

The Jasba-VILLAGE collection with its charming slate relief makes this possible and appeals not only to the eye but also to the tactile sense. Calm colours combined with the slate look create a warm, inviting atmosphere.



Art.	Nennmaß cote nominale nominal size cm	Herstellmaß cote de fabrication production size mm	m ²	Paket carton box	Palette palette pallet	Beanspr.-Gruppe groupe d'emploi wear resist. group	Norm Norme Standard	Trittsicherheit antidérapance non-slip	Preisgruppe groupe de prix price category
3540H						4	B1b GL		W222 (m ²)
3541H						4	B1b GL		W222 (m ²)
3546H	5 x 5	47 x 47 x 6,5	11 Bögen plaques sheets	11 Bögen plaques sheets	64,000 m ²	3	B1b GL		W222 (m ²)
3547H			12,331 kg	1,000 m ² 12,331 kg	789,184 kg	4	B1b GL		W222 (m ²)
3548H						4	B1b GL		W222 (m ²)
3549H						3	B1b GL		W222 (m ²)

Mosaik | mosaïque | mosaic





Steinzeug glasiert | grès émaillé | stoneware glazed

5 x 5 cm





3540H*   
 steinweiß, strukturiert, matt
 blanc pierre, structuré, mat
 stone white, structured, matt







3541H    
 sandbeige, strukturiert, matt
 beige sable, structuré, mat
 sand beige, structured, matt







3546H*   
 erdbraun, strukturiert, matt
 brun terre, structuré, mat
 earth brown, structured, matt







3547H    
 felsgrau, strukturiert, matt
 gris roche, structuré, mat
 rock grey, structured, matt



3548H    
 cotto, strukturiert, matt
 cotto, structuré, mat
 cotto, structured, matt



3549H    
 schiefer, strukturiert, matt
 ardoise, structuré, mat
 slate-colored, structured, matt

Mosaik, rückseitig thermoplastisch verklebt
 Bogen: 297 x 297 mm.

Mosaïque, collage thermoplastique
 sur l'envers Feuille: 297 x 297 mm.

Mosaic, glued thermo-plastically on back
 Sheet: 297 x 297 mm.

*Mosaik, Verklebung rückseitig auf Glasfasernetz,
 Bogen: 297 x 297 mm, ohne Außenfuge

*Mosaïque, collée sur trame en fibre de verre à l'envers,
 Feuille: 297 x 297 mm, sans joint extérieur

*Mosaic, glass fibre net on reverse side,
 Sheet: 297 x 297 mm, without external joint

Art.	Nennmaß cote nominale nominal size cm	Herstellmaß cote de fabrication production size mm	m ²	Paket carton box	Palette palette pallet	Beanspr.-Gruppe groupe d'emploi wear resist. group	Norm Norme Standard	Trittsicherheit antidérapance non-slip	Preisgruppe groupe de prix price category
3500H						4	Bib GL	R10/B	W237 (m ²)
3501H						4	Bib GL	R10/B	W237 (m ²)
3503H	5 x 5	47 x 47 x 6,5	11 Bögen plaques sheets	11 Bögen plaques sheets	64,000 m ²	3	Bib GL	R10/B	W237 (m ²)
3506H			12,331 kg	1,000 m ² 12,331 kg	789,184 kg	3	Bib GL	R10/B	W237 (m ²)
3507H						4	Bib GL	R10/B	W237 (m ²)
3508H						4	Bib GL	R10/B	W237 (m ²)
3509H						3	Bib GL	R10/B	W237 (m ²)

Mosaik | mosaïque | mosaic

Steinzeug glasiert | grès émaillé | stoneware glazed

5 x 5 cm Secura



3500H steinweiß, strukturiert, matt
blanc pierre, structuré, mat
stone white, structured, matt



3501H sandbeige, strukturiert, matt
beige sable, structuré, mat
sand beige, structured, matt



3503H felsgrau-schiefer-mix,
strukturiert, matt
mélange gris roche-ardoise,
structuré, mat
rock grey-slate mix,
structured, matt



3506H erdbraun, strukturiert, matt
brun terre, structuré, mat
earth brown, structured, matt



3507H felsgrau, strukturiert, matt
gris roche, structuré, mat
rock grey, structured, matt



3508H cotto, strukturiert, matt
cotto, structuré, mat
cotto, structured, matt

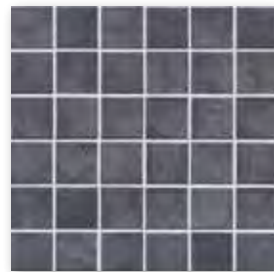

3509H schiefer, strukturiert, matt
ardoise, structuré, mat
slate-colored, structured, matt

Mosaik, rückseitig thermoplastisch verklebt
Bogen: 297 x 297 mm.

Mosaïque, collage thermoplastique
sur l'envers Feuille: 297 x 297 mm.

Mosaic, glued thermo-plastically on back
Sheet: 297 x 297 mm.

Art.	Nennmaß cote nominale nominal size cm	Herstellmaß cote de fabrication production size mm	m ²	Paket carton box	Palette palette pallet	Beanspr.-Gruppe groupe d'emploi wear resist. group	Norm Norme Standard	Trittsicherheit antidérapance non-slip	Preisgruppe groupe de prix price category
0002	30 x 60	316 x 632 x 2,5	5 Bögen plaques sheets 0,380 kg	5 Bögen plaques sheets 1,000 m ² 0,380 kg	30,000 m ² 11,400 kg				W23 (m ²)

Höhenausgleichsmatte
natte de compensation de hauteur
levelling mat



0002Nivella

Jasba-NIVELLA Höenausgleichsmatte

Jasba-NIVELLA dient als Problemlöser für den Ausgleich des Höhenunterschieds zwischen dem Mosaik (6,5 mm) und den Wand- und Bodenfliesen (8 mm). Sie sorgt somit für eine durchgehend ebene Fläche und damit vollendete Raumwirkung. Jasba-NIVELLA ist ideal für die Arbeit mit kleinformatigen Belägen und geeignet für den Innen- und Außenbereich. Ein weiterer Vorteil ist von akustischer Natur: wirkungsvoll minimiert Jasba-NIVELLA eventuelle Hohlklang-Effekte. Auf das jeweilig benötigte Maß zugeschnitten, wird die Matte vollflächig in den Verlegemörtel gedrückt. Die bebilderte, ausführliche Verlegeanleitung finden Sie auf www.jasba.de.

Jasba-NIVELLA natte de compensation de hauteur

La natte Jasba-NIVELLA solutionne de manière optimale le problème de la différence de hauteur entre la mosaïque (6,5 mm) et les carreaux de mur et de sol (8 mm). Elle permet d'obtenir une surface plane et une uniformité parfaite. Jasba-NIVELLA est idéale pour la pose de revêtements de petit format pour l'intérieur et l'extérieur. L'autre avantage de Jasba-NIVELLA est d'ordre acoustique : elle évite la présence de cavités sonnantes creux. Découpée aux dimensions souhaitées, la natte est appliquée sur le support enduit de mortier de pose. Vous trouverez les instructions de pose détaillées et illustrées sur www.jasba.de.

Jasba-NIVELLA levelling mat

Jasba-NIVELLA mats solve the problem of levelling height differences between mosaics (6.5 mm) and wall and floor tiles (8 mm). They therefore ensure a consistently even surface conveying a perfect sensation of space. Jasba-NIVELLA is ideal for working with small-format tiles and suitable for use in both indoor and outdoor applications. Another advantage is of an acoustic nature: Jasba-NIVELLA effectively minimizes any hollow-sounding effects. Cut to the required size, the mat is pressed fully into the tile adhesive. Illustrated installation instructions are provided at www.jasba.de.

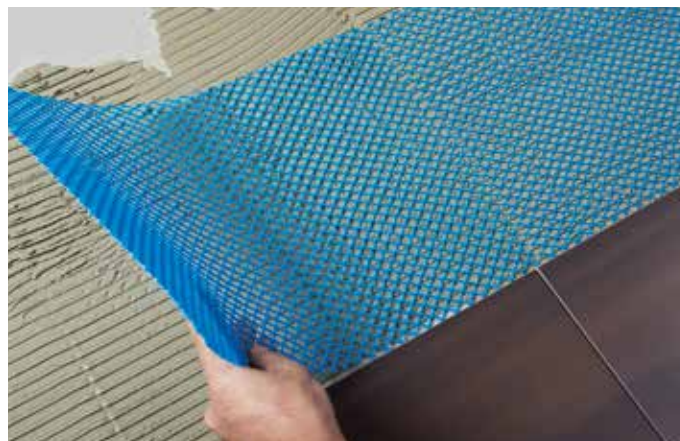



Höhenausgleichsmatte für den gewerblichen und privaten Einsatz im Innen- und Außenbereich (Wand & Boden)

Natte de compensation de hauteur à usage privé et professionnel pour intérieur et extérieur (mur et sol)

Levelling mat for commercial and private use in indoor and outdoor applications (walls / floors)

Eigenschaften:

- Höhengleichend
- Speziell unter kleinformatischen Belägen
- Kein Hohlklang
- Hohe Haftzugfestigkeit

Produktbeschreibung:

Jasba-NIVELLA ist eine spezielle Höhengleichsmatte zur idealen Kombination der Jasba Mosaik (6,5 mm) mit den angebotenen Wand- und Bodenfliesen (8 mm). Hohe Haftzugwerte sowie Biege-, Zug- und Druckfestigkeit sind prägnante Leistungsmerkmale dieser Höhengleichsmatte.

Untergründe:

Untergründe, auf denen Jasba-NIVELLA zum Einsatz kommen soll, müssen grundsätzlich auf Ebenheit, Tragfähigkeit und Oberflächenfestigkeit geprüft werden. Höhenversätze sind auszuschließen. Haftungsmindernde Schichten sind durch Schleifen zu entfernen. Grundierungen, abgestimmt auf Untergrund, Verlegemörtel bzw. Ausgleichsschichten sind gegebenenfalls vorzusehen. Ausgleichspachtelungen, Höhengleiche sind vor dem Verlegen

der Höhengleichsmatte auch für die angrenzenden Beläge herzustellen. Feuchtigkeitsempfindliche Untergründe sind durch entsprechende Abdichtungsmaßnahmen zu schützen.

- Zementäre Untergründe wie Estriche, Beton mind. 28 Tage alt, junge Estriche nach Begehbarkeit bis 7 Tage
- Calciumsulfatestriche mit Restfeuchten < 1%
- Gussasphaltestriche
- Magnesia/Steinholzestriche
- Heizestriche
- Trockenestriche
- Alte, feste keramische Beläge
- Alte Natursteinbeläge
- Gipskartonplatten
- Faserzementplatten
- Putze

Technische Daten

Breite: 316 mm · Länge: 632 mm
 Stärke: 2,5 mm · Farbe: Blau
 Brandklasse: B2
 Verkehrslast bis: 2 KN/m² (Kategorie A1-B1)
 Punktlast für Fliesen im Format 1 x 1 cm:
 Nicht größer als 0,25 KN/cm²
 (entspricht ca. 25 kg/cm²)

Propriétés

- Compensation de hauteur
- Destiné spécialement aux revêtements de petit format
- Absence de bruit creux
- Grande adhérence

Description du produit

mosaïque Jasba (6,5 mm) avec les carrelages de mur et de sol (8 mm) proposés. Cette natte de compensation de hauteur se caractérise par une excellente adhérence ainsi que par une résistance à la flexion, à l'arrachage et à la pression.

Supports

Les supports sur lesquels Jasba-NIVELLA est posé doivent être plans, porteurs et présenter une bonne résistance à l'effritement. Il faut absolument éviter les différences de hauteur. Les couches altérant l'adhérence sont à poncer et, il convient, le cas échéant, prévoir une mise à niveau y compris avec les surfaces avoisinantes. Les supports sensibles à l'humidité sont à étanchéifier avec des mesures appropriées.

- Supports en ciment tels que chape ou béton après au moins 28 jours, chape récente 7 jours après praticabilité
- Chapes de sulfate de calcium avec humidité relative < 1%
- Chapes d'asphalte coulé
- Chapes de magnésie/xytolite
- Chapes chauffantes
- Chapes sèches
- Anciens revêtements en céramique
- Anciens revêtements en pierre naturelle
- Panneaux de placoplâtre
- Panneaux fibrociment
- Crépis

Caractéristiques techniques

Largeur : 316 mm · Longueur : 632 mm
 Epaisseur : 2,5 mm · Couleur : bleu
 Cat. Incendie : B2
 Charge de roulement: 2 KN/m² maxi
 (catégorie A1-B1)
 Charge ponctuelle pour carrelage de format
 1 x 1 cm: inférieure à 0,25 KN/cm²
 (correspond à env. 25 kg/cm²)

Features:

- Levelling
- Especially under small-format coverings
- No hollow sound
- High tensile bond strength

Product description:

The Jasba-NIVELLA is a special levelling mat which is ideal for combining Jasba mosaics (6.5 mm) with the wall and floor tiles (8 mm) offered. High tensile bond strength as well as bending, tensile and compressive strength are the distinctive performance features of this levelling mat.

Surfaces:

The surfaces on which Jasba-NIVELLA is used must be examined for evenness, loadbearing capacity and surface strength. Differences in floor levels must be eliminated. Adhesion-inhibiting layers must be removed by grinding. Primers co-ordinated to the surface, grout and/or levelling layers must also be used. Compensation filling and levelling – including for the adjacent coverings – must be performed prior to fitting the levelling mat. Surfaces which are

sensitive to moisture must be protected by performing the appropriate sealing measures.

- Cement-based surfaces such as screed or concrete must be at least 28 days old; new screed up to 7 days after accessibility.
- Calcium sulphate screed with residual moisture < 1%
- Poured asphalt screed
- Magnesia/Stonewood screed
- Heated screed
- Dry screed
- Old, firm ceramic coverings
- Old natural stone coverings
- Plasterboard
- Fibre cement boards
- Plaster

Technical data

Width: 316 mm · Length: 632 mm
 Thickness: 2.5 mm · Color: blue
 Fire class: B2
 Load resistance: 2 KN/m² (category A1-B1)
 Spot load for tiles in 1 x 1 cm format:
 not greater than 0,25 KN/cm²
 (approx. 25 kg/cm²)

Lotrechte Nutzlasten für Decken nach DIN 1055-3 (Auszug)				
Kategorie	Nutzung	Beispiele	Flächenlast Q _k (kN/m ²)	Einzellast Q _k (kN)
A1	Spitzböden	Dachraum bis 1,8 m lichter Höhe	1,0	1,0
A2	Wohn- und Aufenthaltsräume	Räume mit ausreichender Querverteilung der Lasten wie Räume und Flure in Wohngebäuden, Hotelzimmern, sowie Bettenräume in Krankenhäusern	1,5	–
A3		wie A2, aber ohne ausreichende Querverteilung	2,0	1,0
B1	Büro, Arbeitsflächen	Flure in Bürogebäuden, Büroflächen, Arztpraxen, Stationsräume, Aufenthaltsräume einschl. der Flure, Kleinviehställe	2,0	2,0

Verarbeitung:

Auf den vorbereiteten Untergrund geeigneten Fliesenkleber nach DIN EN 12004 C2 und DIN EN 12002 S1 auftragen. Die Matten der Jasba-NIVELLA werden auf das erforderliche Maß zugeschnitten und vollflächig in den zuvor aufgetragenen Kleber eingebettet und dicht gestoßen. Der Fliesenkleber wird gleichmäßig in die Vertiefungen (Gitterstruktur) eingespachtelt. Die Gitterhohlräume müssen hierbei überall zu 100% gefüllt werden. Mit der entsprechenden Zahnleiste den Verlegemörtel aufkämmen und das Jasba Mosaik verlegen. Frühestens nach 24 Stunden werden die Flächen mit einem kunststoffvergüteten Fugenmörtel verfügt.

Achtung:

Die richtige und damit erfolgreiche Anwendung unserer Produkte unterliegt nicht unserer Kontrolle. Eine Gewährleistung kann deshalb nur für die Güte unserer Erzeugnisse im Rahmen unserer Verkaufs- und Lieferbedingungen (einzusehen unter www.jasba.de/impressum.html), nicht aber für die erfolgreiche Verarbeitung übernommen werden. Veränderungen, die einen technischen Fortschritt bedeuten, behalten wir uns vor.

Charges utiles d'aplomb pour planchers selon DIN 1055-3 (extrait)				
Catégorie	Usage	Exemples	Charge en surface Q _k (kN/m ²)	Charge unique Q _k (kN)
A1	Combles	Grenier jusqu'à 1,8 m de hauteur de passage	1,0	1,0
A2	Pièces d'habitation et salles de séjour	Pièces avec une distribution latérale suffisante des charges comme espaces et couloirs dans les logements, les chambres d'hôtel ainsi que les chambres dans les hôpitaux	1,5	–
A3		comme A2 mais sans distribution latérale suffisante	2,0	1,0
B1	Espaces de bureaux et de travail	Couloirs dans bâtiments de bureaux, espaces bureaux, cabinets médicaux, salles d'attente, salles de séjour y compris couloirs, étables pour bétail de petite taille	2,0	2,0

Application :

Enduire le support préparé avec un mortier colle adapté selon DIN EN 12004 C2 et DIN EN 12002 S1. Les nattes Jasba-NIVELLA sont découpées à la dimension requise et collées sur toute la surface en ayant pris soin d'avoir rempli les cavités à 100%. Appliquer le mortier colle avec un peigne cranté adéquat et poser la mosaïque Jasba. Le jointoiement peut être effectué au plus tôt après 24 heures avec un mortier de joint approprié.

Attention :

La pose correcte de nos produits n'est pas de notre ressort. Par conséquent, il n'est pas possible d'endosser une quelconque responsabilité pour l'application de nos produits dans le cadre de nos conditions générales de vente (à consulter sur www.jasba.de/impressum.html), celle-ci ne portant que sur leur qualité. Sous réserve de modifications dans le cadre du progrès technique.

Vertical payloads for ceilings to DIN 1055-3 (excerpt)				
Category	Application	Examples	Distributed load Q _k (kN/m ²)	Point load Q _k (kN)
A1	Attics	Attic space to clear height of 1.8 m	1.0	1.0
A2	Residential and recreational applications	Rooms with sufficient lateral load distribution such as rooms and corridors in residential buildings, hotel rooms and hospital wards	1.5	–
A3		As for A2 but without sufficient lateral distribution	2.0	1.0
B1	Office and working areas	Corridors in office buildings, office space, doctors' surgeries, wards, recreational rooms incl. corridors, stables	2.0	2.0

Installation:

Apply suitable tile adhesive to the prepared surface in accordance with DIN EN 12004 C2 and DIN EN 12002 S1. Jasba-NIVELLA mats are cut to the required size, fully embedded in the adhesive and laid edge to edge. The tile adhesive is filled consistently in the grooves (mesh structure). The mesh cavities must be 100% filled. Using the corresponding toothed bar, comb out the adhesive and lay the Jasba mosaics. At the earliest after 24 hours, the areas are grouted using a polymer-modified mortar.

Attention:

The correct and therefore successful application of our products is beyond our control. A guarantee can therefore only be given for the quality of our products within the framework of our terms and conditions governing sale and delivery (please refer to www.jasba.de/impressum.html) but not for successful installation thereof. We retain the right to modifications representing technical progress.





Leichtigkeit, Kraft und Vergnügen

Inspiriert von afrikanischer Handwerkskunst wirkt die Serie Kiano beschwingt und kraftvoll zugleich. Eine Mischung aus Stein und Zement, die durch den Wechsel von ruhigen Elementen und markanten Äderungen geprägt ist, bildet die Basis der Serie. Die trittsicheren Bodenfliesen stehen in zwei Formaten und vier Farbtönen zur Verfügung. Assoziationen an jahrhundertealte Höhlenmalerei weckt die leicht reliefierte Wandfliese „Stroke“, die ebenfalls als Riegelformat erhältlich ist. Die Mosaikmatte „Chess“ im Schachbrettmuster besticht durch ihre handwerkliche Linie. Das Mosaik „Messing“ taucht das afrikanische Muster in einen metallischen Glanz und rundet die Serie ab.

Légèreté, force et plaisir

Inspirée de l'art artisanal africain, la gamme Kiano regorge de vitalité et d'énergie. Un mélange de pierre et de ciment marqué par l'alternance d'éléments apaisés et d'un veinage plus prononcé constituent la base de cette gamme. Les carreaux de sol antidérapants sont proposés en deux formats et quatre teintes différentes. Également disponible en format bandeau, le carreau de mur « Stroke », au relief filigrane, est inspiré de peintures rupestres séculaires. La mosaïque sur trame « Chess » au motif de damier séduit par son aspect artisanal. La mosaïque « laiton » qui confère au motif africain une aura métallique vient avantageusement compléter la gamme.

Lightness, power and pleasure

Inspired by traditional African art, the Kiano range is both lively and powerful. It is based on a combination of stone and cement characterised by the transformation from calm elements and distinctive changes. The non-slip floor tiles are available in two formats and four colors. Associations with centuries-old cave drawings are intimated by the slightly moulded "Stroke" wall tile which is also available in strip format. The "Chess" mosaic mat in a checkerboard pattern is distinctive through its artisanal contours. The "brass" mosaic attributes the African pattern a metallic sheen and rounds off the range.

Art.	Nennmaß cote nominale nominal size cm	Herstellmaß cote de fabrication production size mm	m ²	Paket carton box	Palette palette pallet	Beanspr.-Gruppe groupe d'emploi wear resist. group	Norm Norme Standard	Trittsicherheit antidérapance non-slip	Preisgruppe groupe de prix price category
283106H	30 x 60	297 x 597 x 9	5,556 St pc	9 St pc	77,754 m ²		BIII GL		W111 (m ²)
283107H			14,946 kg	1,620 m ² 24,210 kg	1.162,080 kg		BIII GL		W117 (m ²)
363360H	35 x 100	347 x 997 x 6	2,857 St pc	5 St pc	70,000 m ²		BIII GL		W156 (m ²)
363361H			10,108 kg	1,750 m ² 17,690 kg	707,600 kg		BIII GL		W162 (m ²)

Wandfliese | carreau de mur | wall tile

Steingut glasiert | faïence émaillée | earthenware glazed

30 x 60 cm



283106H

sand weiß | blanc sable | sand-white
eben, seidenmatt | lisse, satinée | smooth, silky-glossy



30 x 60 cm



283107H

Stroke
sand weiß | blanc sable | sand-white
eben, seidenmatt | lisse, satinée | smooth, silky-glossy



35 x 100 cm



363360H

sand weiß | blanc sable | sand-white
eben, seidenmatt | lisse, satinée | smooth, silky-glossy

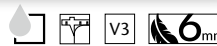

35 x 100 cm



363361H

Stroke
sand weiß | blanc sable | sand-white
eben, seidenmatt | lisse, satinée | smooth, silky-glossy



Art.	Nennmaß cote nominale nominal size cm	Herstellmaß cote de fabrication production size mm	m	Paket carton box	Palette palette pallet	Beanspr.-Gruppe groupe d'emploi wear resist. group	Norm Norme Standard	Trittsicherheit antidérapance non-slip	Preisgruppe groupe de prix price category
431946							Bla UGL	R10/A	W571 (St pc)
431947	30 x 30	297 x 297 x 10,5	3,333 St pc	2 St pc			Bla UGL	R10/A	W571 (St pc)
431948			5,123 kg	0,600 m	3,074 kg		Bla UGL	R10/A	W571 (St pc)
431949							Bla UGL	R10/A	W571 (St pc)
363362							Bla UGL	R10/A	W571 (St pc)
363363	30 x 30	297 x 297 x 6	3,333 St pc	3 St pc			Bla UGL	R10/A	W571 (St pc)
363364			2,926 kg	0,900 m	2,634 kg		Bla UGL	R10/A	W571 (St pc)
363365							Bla UGL	R10/A	W571 (St pc)

Dekorationselemente | éléments décoratifs | decoration elements

Mosaikmatte Chess | mosaïque Chess | mosaic sheet Chess

Feinsteinzeugfliesen unglasiert | grès cérame fin vitrifié non-émaillés | porcelain stoneware tiles unglazed

30 x 30 cm



431946
 elfenbein weiß, strukturiert,
 mit Glanzapplikation
 blanc ivoire, structuré,
 avec application brillante
 ivory-white, structured,
 with gloss application



431947
 sahara beige, strukturiert,
 mit Glanzapplikation
 sahara beige, structuré,
 avec application brillante
 sahara beige, structured,
 with gloss application

363363
 sahara beige, strukturiert,
 mit Glanzapplikation
 sahara beige, structuré,
 avec application brillante
 sahara beige, structured,
 with gloss application



431948
 atlas grau, strukturiert,
 mit Glanzapplikation
 gris atlas, structuré,
 avec application brillante
 atlas grey, structured,
 with gloss application



431949
 kohleschwarz, strukturiert,
 mit Glanzapplikation
 noir carbone, structuré,
 avec application brillante
 coal-black, structured,
 with gloss application

363365
 kohleschwarz, strukturiert,
 mit Glanzapplikation
 noir carbone, structuré,
 avec application brillante
 coal-black, structured,
 with gloss application

Abgabe der Dekorationselemente ausschließlich in vollen Kartons.
 Éléments décoratifs uniquement livrables en cartons entiers.
 Decoration elements only available in full boxes.

Mosaik, Verklebung rückseitig auf
 Glasfasernetz, Bogen: 297 x 297 mm.

Mosaïque, collée sur trame en fibre de
 verre à l'envers, Feuille: 297 x 297 mm.

Mosaic, glass fibre net on reverse side,
 Sheet: 297 x 297 mm.

Art.	Nennmaß cote nominale nominal size cm	Herstellmaß cote de fabrication production size mm	m ² /m	Paket carton box	Palette palette pallet	Beanspr.-Gruppe groupe d'emploi wear resist. group	Norm Norme Standard	Trittsicherheit antidérapance non-slip	Preisgruppe groupe de prix price category
283110H	10 x 25	97 x 247 x 9	40 St pc / m ²	20 St pc	64,000 m ²		Bib GL		W162 (m ²)
283111H			19,000 kg	0,500 m ² 9,500 kg	1.216,000 kg		Bib GL		W162 (m ²)
363366H	10 x 25	97 x 247 x 6	40 St pc / m ²	30 St pc	96,000 m ²		Bib GL		W162 (m ²)
363367H			12,640 kg	0,750 m ² 9,480 kg	1.213,440 kg		Bib GL		W162 (m ²)
283112H	5 x 5	47 x 47 x 6,5	3,333 St pc / m	11 St pc			Bib GL		W448 (St pc)
			3,736 kg	3,300 m	12,331 kg				

Dekorationselemente | éléments décoratifs | decoration elements

Dekorfliese Stroke | carreau décoratif Stroke | decorative element Stroke

Steinzeug glasiert | grès émaillé | stoneware glazed

10 x 25 cm

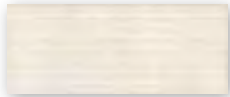

283110H   

light, strukturiert,
mit Glanzapplikation
light, structuré,
avec application brillante
light, structured,
with gloss application

363366H    

light, strukturiert,
mit Glanzapplikation
light, structuré,
avec application brillante
light, structured,
with gloss application

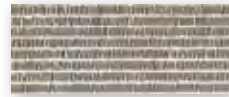

283111H   

dark, strukturiert,
mit Glanzapplikation
dark, structuré,
avec application brillante
dark, structured,
with gloss application

363367H    

dark, strukturiert,
mit Glanzapplikation
dark, structuré,
avec application brillante
dark, structured,
with gloss application

Nur für die Verlegung an der Wand geeignet.
Convient uniquement pour une pose murale.
Only suitable for laying on the wall.

Mosaikmatte Messing | mosaïque laiton | mosaic sheet brass

Steinzeug glasiert | grès émaillé | stoneware glazed

5 x 5 cm



Mosaik, Verklebung rückseitig auf
Glasfasernetz, Bogen: 297 x 297 mm.
Nur für die Verlegung an der Wand
geeignet.

Mosaïque, collée sur trame en fibre de
verre à l'envers, Feuille: 297 x 297 mm.
Convient uniquement pour une pose
murale.

Mosaic, glass fibre net on reverse side,
Sheet: 297 x 297 mm. Only suitable for
laying on the wall.

283112H    

messing, strukturiert,
mit Glanzapplikation
laiton, structuré,
avec application brillante
brass, structured,
with gloss application

Abgabe der Dekorationselemente ausschließlich in vollen Kartons.
Éléments décoratifs uniquement livrables en cartons entiers.
Decoration elements only available in full boxes.

Art.	Nennmaß cote nominale nominal size cm	Herstellmaß cote de fabrication production size mm	m ²	Paket carton box	Palette palette pallet	Beanspr.-Gruppe groupe d'emploi wear resist. group	Norm Norme Standard	Trittsicherheit antidérapance non-slip	Preisgruppe groupe de prix price category
431930							Bla UGL	R10/A	W123 (m ²)
431931	30 x 60	297 x 597 x 10,5	5,556 St pc	6 St pc	43,197 m ²		Bla UGL	R10/A	W123 (m ²)
431932			23,224 kg	1,080 m ² 25,080 kg	1.003,200 kg		Bla UGL	R10/A	W123 (m ²)
431933							Bla UGL	R10/A	W123 (m ²)
431934							Bla UGL	R10/A	W138 (m ²)
431935	60 x 60	597 x 597 x 10,5	2,778 St pc	3 St pc	38,877 m ²		Bla UGL	R10/A	W138 (m ²)
431936			23,769 kg	1,080 m ² 25,668 kg	924,048 kg		Bla UGL	R10/A	W138 (m ²)
431937							Bla UGL	R10/A	W138 (m ²)



elfenbein weiß
blanc ivoire
ivory-white



sahara beige



atlas grau
gris atlas
atlas grey

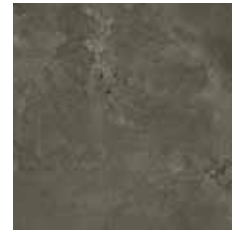

kohleschwarz
noir carbone
coal-black



Bodenfliese | carreau de sol | floor tile

Feinsteinzeugfliesen unglasiert | grès cérame fin vitrifié non-émaillés | porcelain stoneware tiles unglazed

30 x 60 cm



431930

elfenbein weiß, strukturiert, mit Glanzapplikation
blanc ivoire, structuré, avec application brillante
ivory-white, structured, with gloss application

431931

sahara beige, strukturiert, mit Glanzapplikation
sahara beige, structuré, avec application brillante
sahara beige, structured, with gloss application

431932

atlas grau, strukturiert, mit Glanzapplikation
gris atlase, structuré, avec application brillante
atlas grey, structured, with gloss application

431933

kohleschwarz, strukturiert, mit Glanzapplikation
noir carbone, structuré, avec application brillante
coal-black, structured, with gloss application

60 x 60 cm



431934

elfenbein weiß, strukturiert, mit Glanzapplikation
blanc ivoire, structuré, avec application brillante
ivory-white, structured, with gloss application

431935

sahara beige, strukturiert, mit Glanzapplikation
sahara beige, structuré, avec application brillante
sahara beige, structured, with gloss application

431936

atlas grau, strukturiert, mit Glanzapplikation
gris atlase, structuré, avec application brillante
atlas grey, structured, with gloss application

431937

kohleschwarz, strukturiert, mit Glanzapplikation
noir carbone, structuré, avec application brillanten
coal-black, structured, with gloss application

Art.	Nennmaß cote nominale nominal size cm	Herstellmaß cote de fabrication production size mm	m	Paket carton box	Palette palette pallet	Beanspr.-Gruppe groupe d'emploi wear resist. group	Norm Norme Standard	Trittsicherheit antidérapance non-slip	Preisgruppe groupe de prix price category
431938							Bla UGL	R10/A	W473 (St pc)
431939	30 x 60	297 x 597 x 10,5	1,667 St pc	6 St pc			Bla UGL	R10/A	W473 (St pc)
431940			6,968 kg	3,599 m	25,080 kg		Bla UGL	R10/A	W473 (St pc)
431941							Bla UGL	R10/A	W473 (St pc)
431942							Bla UGL		W439 (St pc)
431943	7 x 60	70 x 597 x 10,5	1,667 St pc	22 St pc			Bla UGL		W439 (St pc)
431944			1,717 kg	13,197 m	22,660 kg		Bla UGL		W439 (St pc)
431945							Bla UGL		W439 (St pc)



elfenbein weiß
blanc ivoire
ivory-white



sahara beige



atlas grau
gris atlas
atlas grey

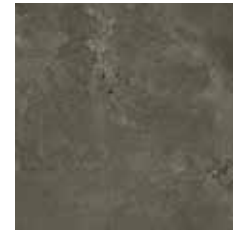

kohleschwarz
noir carbone
coal-black



Treppenfliese | nez de marche | stair tile

Feinsteinzeugfliesen unglasiert | grès cérame fin vitrifié non-émaillés | porcelain stoneware tiles unglazed

30 x 60 cm



431938

elfenbein weiß, strukturiert, mit Glanzapplikation
blanc ivoire, structuré, avec application brillante
ivory-white, structured, with gloss application

431939

sahara beige, strukturiert, mit Glanzapplikation
sahara beige, structuré, avec application brillante
sahara beige, structured, with gloss application

431940

atlas grau, strukturiert, mit Glanzapplikation
gris atlas, structuré, avec application brillante
atlas grey, structured, with gloss application

431941

kohleschwarz, strukturiert, mit Glanzapplikation
noir carbone, structuré, avec application brillante
coal-black, structured, with gloss application

Auftragsfertigung: Rückgabe und/oder Stornierung
bestellter Ware nicht möglich.

Fabrication sur commande : il nous est impossible d'accepter
l'annulation de commandes d'articles ou le retour d'articles.

Make-to-order production: return and/or cancellation
of ordered products not possible.

Sockel, geschnitten | plinthe, à bord vif | skirting, cut

Feinsteinzeugfliesen unglasiert | grès cérame fin vitrifié non-émaillés | porcelain stoneware tiles unglazed

7 x 60 cm

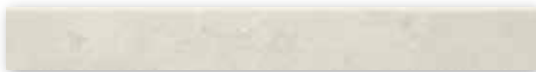

431942

elfenbein weiß, strukturiert, mit Glanzapplikation
blanc ivoire, structuré, avec application brillante
ivory-white, structured, with gloss application

431943

sahara beige, strukturiert, mit Glanzapplikation
sahara beige, structuré, avec application brillante
sahara beige, structured, with gloss application

431944

atlas grau, strukturiert, mit Glanzapplikation
gris atlas, structuré, avec application brillante
atlas grey, structured, with gloss application

431945

kohleschwarz, strukturiert, mit Glanzapplikation
noir carbone, structuré, avec application brillante
coal-black, structured, with gloss application

Art.	Nennmaß cote nominale nominal size cm	Herstellmaß cote de fabrication production size mm	m ²	Paket carton box	Palette palette pallet	Beanspr.-Gruppe groupe d'emploi wear resist. group	Norm Norme Standard	Trittsicherheit antidérapance non-slip	Preisgruppe groupe de prix price category
431950H							Bla UGL	R10/B	W177 (m ²)
431951H	5 x 5	47 x 47 x 6,5	11 Bögen plaques sheets	11 Bögen plaques sheets	64,000 m ²		Bla UGL	R10/B	W177 (m ²)
431952H			12,331 kg	1,000 m ² 12,331 kg	789,184 kg		Bla UGL	R10/B	W177 (m ²)
431953H							Bla UGL	R10/B	W177 (m ²)

Mosaik | mosaïque | mosaic

Feinsteinzeugfliesen unglasiert | grès cérame fin vitrifié non-émaillés | porcelain stoneware tiles unglazed

5 x 5 cm



431950H

elfenbein weiß, strukturiert, mit Glanzapplikation
blanc ivoire, structuré, avec application brillante
ivory-white, structured, with gloss application

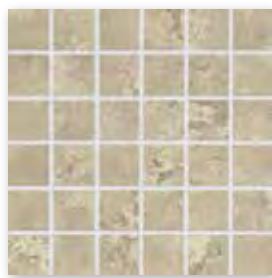

431951H

sahara beige, strukturiert, mit Glanzapplikation
sahara beige, structuré, avec application brillante
sahara beige, structured, with gloss application



431952H

atlas grau, strukturiert, mit Glanzapplikation
gris atlaste, structuré, avec application brillante
atlas grey, structured, with gloss application

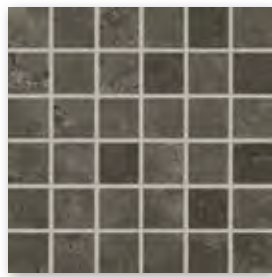

431953H

kohleschwarz, strukturiert, mit Glanzapplikation
noir carbone, structuré, avec application brillante
coal-black, structured, with gloss application

Mosaik, rückseitig thermoplastisch verklebt
Bogen: 297 x 297 mm

Mosaïque, collage thermoplastique sur l'envers
Feuille: 297 x 297 mm

Mosaic, glued thermo-plastically on back
Sheet: 297 x 297 mm

Elegant und vertraut

La Casa kann mit ihren klassischen Grundfarben in unterschiedlichen Stilwelten eingesetzt werden. Alle Wandfliesen sind durch die Hytect-Oberfläche besonders reinigungsfreundlich. Mit Bordüren und farblich abgestimmten Stäbchenmosaiken bietet die Serie einen kleinen Baukasten an Wand- und Dekorationselementen für vielseitige Gestaltungen – zeitlos und dezent.

Élégante et familière

Avec ses couleurs de base classiques, La Casa peut être utilisée dans différents univers de style. Tous les carreaux de mur sont particulièrement faciles à nettoyer grâce à la surface Hytect. Avec des bordures et des mosaïques de baguettes aux couleurs assorties, la série offre un petit kit de construction d'éléments muraux et décoratifs pour des designs polyvalents – hors temps et discrets.

Elegant and familiar

With its classic basic colours, La Casa can be used in different style worlds. All wall tiles are particularly easy to clean thanks to the Hytect surface. With borders and rod mosaics in matching colours, the series offers a small modular system of wall and decorative elements for versatile designs – timeless and discreet.





Art.	Nennmaß cote nominale nominal size cm	Herstellmaß cote de fabrication production size mm	m ²	Paket carton box	Palette palette pallet	Beanspr.-Gruppe groupe d'emploi wear resist. group	Norm Norme Standard	Trittsicherheit antidérapance non-slip	Preisgruppe groupe de prix price category
182105H							BIII GL		C89 (m ²)
182106H	20 x 40	197 x 397 x 7,5	12,500 St pc	16 St pc	92,160 m ²		BIII GL		C89 (m ²)
182818H			12,975 kg	1,280 m ² 16,608 kg	1.195,776 kg		BIII GL		C89 (m ²)
182821H							BIII GL		C89 (m ²)
382819H	20 x 60	197 x 597 x 9	8,333 St pc	8 St pc	61,442 m ²		BIII GL		C101 (m ²)
382822H			15,516 kg	0,960 m ² 14,896 kg	953,344 kg		BIII GL		C101 (m ²)

Wandfliese | carreau de mur | wall tile

Steingut glasiert | faïence émaillée | earthenware glazed

20 x 40 cm

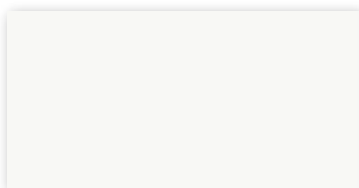
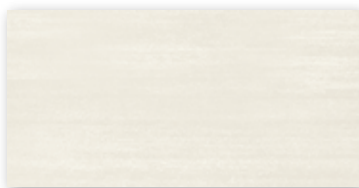
**182105H**weiß | blanc | white
eben, seidenmatt | lisse, satinée | smooth, silky-glossy**182106H**weiß | blanc | white
eben, glänzend | lisse, brillant | smooth, glossy**182818H**hellgrau | gris clair | light-grey
eben, seidenmatt | lisse, satinée | smooth, silky-glossy**182821H**naturbeige | beige nature | natural-beige
eben, seidenmatt | lisse, satinée | smooth, silky-glossy

20 x 60 cm

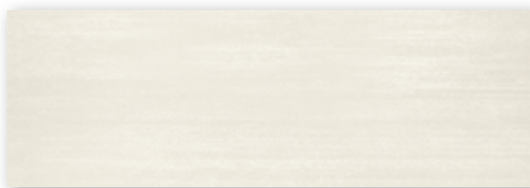
**382819H**hellgrau | gris clair | light-grey
eben, seidenmatt | lisse, satinée | smooth, silky-glossy**382822H**naturbeige | beige nature | natural-beige
eben, seidenmatt | lisse, satinée | smooth, silky-glossy

Art.	Nennmaß cote nominale nominal size cm	Herstellmaß cote de fabrication production size mm	m ²	Paket carton box	Palette palette pallet	Beanspr.-Gruppe groupe d'emploi wear resist. group	Norm Norme Standard	Trittsicherheit antidérapance non-slip	Preisgruppe groupe de prix price category
282813H							BIII GL		C101 (m ²)
282814H							BIII GL		C101 (m ²)
282815H	30 x 60	297 x 597 x 9	5,556 St pc	9 St pc	77,754 m ²		BIII GL		C101 (m ²)
282817H			14,946 kg	1,620 m ² 24,210 kg	1.162,080 kg		BIII GL		C101 (m ²)
282820H							BIII GL		C101 (m ²)
282823H							BIII GL		C101 (m ²)

Wandfliese | carreau de mur | wall tile

Steingut glasiert | faïence émaillée | earthenware glazed

30 x 60 cm

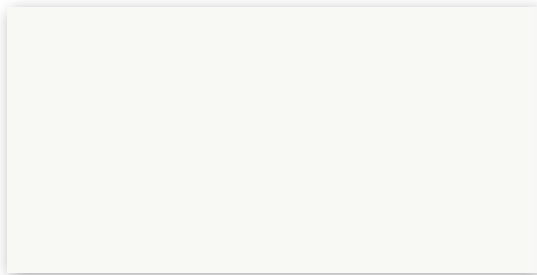

282813H

weiß | blanc | white
eben, seidenmatt | lisse, satinée | smooth, silky-glossy

282814H

weiß | blanc | white
eben, glänzend | lisse, brillant | smooth, glossy

282820H

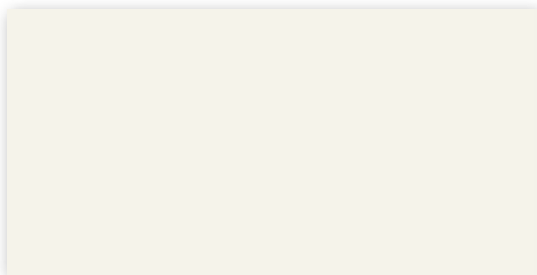
hellgrau | gris clair | light-grey
eben, seidenmatt | lisse, satinée | smooth, silky-glossy

282815H

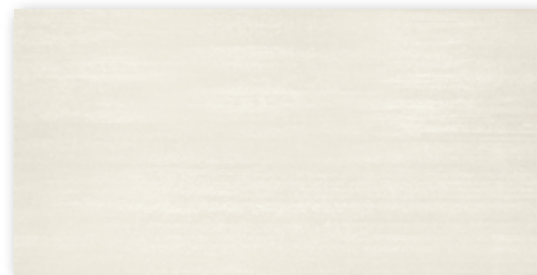
hellbeige | beige clair | light-beige
eben, glänzend | lisse, brillant | smooth, glossy

282823H

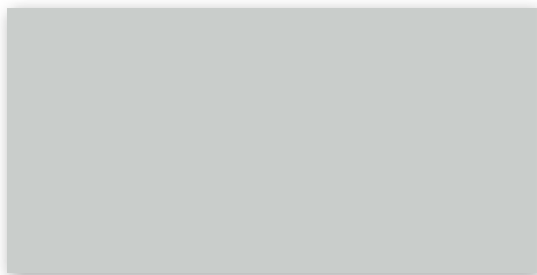
naturbeige | beige nature | natural-beige
eben, seidenmatt | lisse, satinée | smooth, silky-glossy

282817H

grau | gris | grey
eben, glänzend | lisse, brillant | smooth, glossy

Art.	Nennmaß cote nominale nominal size cm	Herstellmaß cote de fabrication production size mm	m ²	Paket carton box	Palette palette pallet	Beanspr.-Gruppe groupe d'emploi wear resist. group	Norm Norme Standard	Trittsicherheit antidérapance non-slip	Preisgruppe groupe de prix price category
283073H							BIII GL		C101 (m ²)
283074H	30 x 60	297 x 597 x 9	5,556 St pc	9 St pc	77,754 m ²		BIII GL		C101 (m ²)
283075H			14,946 kg	1,620 m ² 24,210 kg	1.162,080 kg		BIII GL		C101 (m ²)
283076H							BIII GL		C101 (m ²)

Wandfliese | carreau de mur | wall tile

Steingut glasiert | faïence émaillée | earthenware glazed

30 x 60 cm

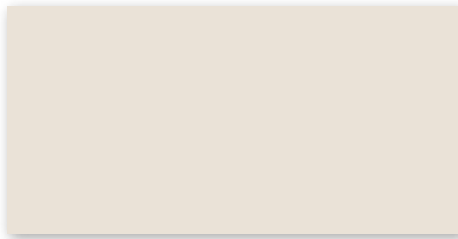
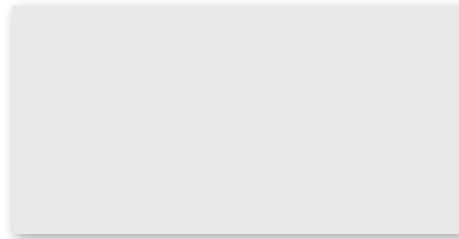
**283073H**desert sand | sable désert| desert sand
eben, glänzend | lisse, brillant | smooth, glossy**283075H**light grey | gris clair| light grey
eben, glänzend | lisse, brillant | smooth, glossy**283074H**taupe | taupe| taupe
eben, glänzend | lisse, brillant | smooth, glossy**283076H**medium grey | gris moyen| medium grey
eben, glänzend | lisse, brillant | smooth, glossy

Art.	Nennmaß cote nominale nominal size cm	Herstellmaß cote de fabrication production size mm	m	Paket carton box	Palette palette pallet	Beanspr.-Gruppe groupe d'emploi wear resist. group	Norm Norme Standard	Trittsicherheit antidérapance non-slip	Preisgruppe groupe de prix price category
182825	3,7 x 40	37 x 397 x 8	2,500 St pc	5 St pc			Alb UGL		C437 (St pc)
182827			0,645 kg	2,000 m	1,290 kg		Alb UGL		C437 (St pc)
282824	3,7 x 60	37 x 597 x 10,5	1,667 St pc	3 St pc			Alb UGL		C437 (St pc)
282826			0,845 kg	1,800 m	1,521 kg		Alb UGL		C437 (St pc)
182125							Alb UGL	R9	C491 (St pc)
182126	30 x 30	297 x 297 x 8	3,333 St pc	11 St pc			Alb UGL	R9	C491 (St pc)
182127			5,333 kg	3,300 m	17,600 kg		Alb UGL	R9	C491 (St pc)

Dekorationselemente | éléments décoratifs | decoration elements

Bordüre | bordure | border

Feinsteinzeugfliesen unglasiert | grès cérame fin vitrifié non-émaillés | porcelain stoneware tiles unglazed

3,7 x 40 cm



182825

basalt metallic | basalte métallisé | basalt metallic
eben, matt | lisse, mat | smooth, matt

3,7 x 60 cm



282824

basalt metallic | basalte métallisé | basalt metallic
eben, matt | lisse, mat | smooth, matt



182827

schlamm-braun metallic | brun boue métallisé | mud-brown metallic
eben, matt | lisse, mat | smooth, matt



282826

schlamm-braun metallic | brun boue métallisé | mud-brown metallic
eben, matt | lisse, mat | smooth, matt



Dekorationselemente | éléments décoratifs | decoration elements

Mosaik | mosaïque | mosaic

Feinsteinzeugfliesen unglasiert | grès cérame fin vitrifié non-émaillés | porcelain stoneware tiles unglazed

30 x 30 cm



182125

beige-braun-Mix
mélange beige-brun
beige-brown mix
eben, matt | lisse, mat | smooth, matt

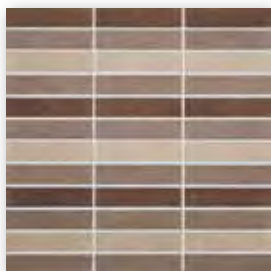

182126

braun-Mix
mélange brun
brown mix
eben, matt | lisse, mat | smooth, matt

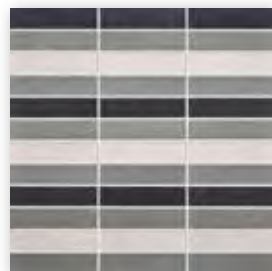

182127

grau-Mix
mélange gris
grey mix
eben, matt | lisse, mat | smooth, matt



Mosaik, Verklebung rückseitig
auf Glasfasernetz, Bogen: 297 x 297 mm
Mosaïque, collée sur trame en fibre
de verre à l'envers, Feuille : 297 x 297 mm
Mosaic, glass fibre net on reverse side,
Sheet: 297 x 297 mm

Abgabe der Dekorationselemente ausschließlich in vollen Kartons.
Éléments décoratifs uniquement livrables en cartons entiers.
Decoration elements only available in full boxes.





Fliesen für Lebensräume

Fliesen für Lebensräume – privates Wohnen, Gastronomie & Hotellerie oder öffentliche Gebäude in denen das Wohlfühlen im Vordergrund steht. Räume in denen man sich gerne aufhält. Like ist eine Fliesenkollektion, die dafür gemacht ist, im Zusammenspiel mit anderen Materialien ein perfektes Ganzes zu ergeben. Die Optik ist dezent lebendig – feine Unregelmäßigkeiten geben den Fliesen ihren unverwechselbaren Charakter und bringen jede der 5 Farben perfekt zur Geltung. Ob Mosaik oder Großformat, die Serie Like entfaltet immer ihren vollen Charme – sowohl im Raum als auch auf der Terrasse.

Les carreaux pour les espaces de vie

Les carreaux pour les espaces de vie – habitat privé, gastronomie et hôtellerie ou bâtiments publics dans lesquels l'accent est mis sur le bien-être. Des locaux dans lesquels on aime passer du temps. Like est une collection de carreaux faite pour créer un ensemble parfait lorsqu'elle est combinée avec d'autres matériaux. L'aspect est décentement vivant – de fines irrégularités donnent aux carreaux leur caractère unique et font ressortir chacune des 5 couleurs à la perfection. Qu'elle soit en mosaïque ou en grand format, la série Like déploie toujours tout son charme – tant dans la pièce qu'en terrasse.

Tiles for living spaces

Tiles for living spaces – private living, gastronomy & hotels or public buildings in which the focus is on well-being. Rooms in which one likes to spend time. LIKE is a tile collection that is made to create a perfect whole in combination with other materials. The look is discreetly lively – fine irregularities give the tiles their unmistakable character and bring out each of the 5 colors perfectly. Whether mosaic or large format, the LIKE series always unfolds its full charm – both in the room and on the terrace.

Art.	Nennmaß cote nominale nominal size cm	Herstellmaß cote de fabrication production size mm	m ²	Paket carton box	Palette palette pallet	Beanspr.-Gruppe groupe d'emploi wear resist. group	Norm Norme Standard	Trittsicherheit antidérapance non-slip	Preisgruppe groupe de prix price category
430645							Bla UGL	R10/A+B	W102 (m ²)
430646							Bla UGL	R10/A+B	W102 (m ²)
430647	30 x 60	297 x 596 x 9	5,556 St pc	7 St pc	50,396 m ²		Bla UGL	R10/A+B	W102 (m ²)
430648			19,841 kg	1,260 m ² 25,000 kg	999,880 kg		Bla UGL	R10/A+B	W102 (m ²)
430649							Bla UGL	R10/A+B	W102 (m ²)
430650							Bla UGL	R10/A+B	W117 (m ²)
430651							Bla UGL	R10/A+B	W117 (m ²)
430652	60 x 60	596 x 596 x 9	2,778 St pc	3 St pc	43,197 m ²		Bla UGL	R10/A+B	W117 (m ²)
430653			19,288 kg	1,080 m ² 20,829 kg	833,160 kg		Bla UGL	R10/A+B	W117 (m ²)
430654							Bla UGL	R10/A+B	W117 (m ²)



graphite



ash grey



cement



warm grey



off white



Bodenfliese | carreau de sol | floor tile

Feinsteinzeugfliesen unglasiert | grès cérame fin vitrifié non-émaillés | porcelain stoneware tiles unglazed

30 x 60 cm



430645
graphite
strukturiert, matt
structuré, mat
structured, matt



430646
ash grey
strukturiert, matt
structuré, mat
structured, matt

430648
warm grey
strukturiert, matt
structuré, mat
structured, matt

430647
cement
strukturiert, matt
structuré, mat
structured, matt

430649
off white
strukturiert, matt
structuré, mat
structured, matt

60 x 60 cm



430650
graphite
strukturiert, matt
structuré, mat
structured, matt

430651
ash grey
strukturiert, matt
structuré, traité
structured, matt

430652
cement
strukturiert, matt
structuré, mat
structured, matt

430653
warm grey
strukturiert, matt
structuré, mat
structured, matt



430654
off white
strukturiert, matt
structuré, mat
structured, matt

Art.	Nennmaß cote nominale nominal size cm	Herstellmaß cote de fabrication production size mm	m ²	Paket carton box	Palette palette pallet	Beanspr.-Gruppe groupe d'emploi wear resist. group	Norm Norme Standard	Trittsicherheit antidérapance non-slip	Preisgruppe groupe de prix price category
430655							Bla UGL	R10/A+B	W138 (m ²)
430656							Bla UGL	R10/A+B	W138 (m ²)
430657	80 x 80	795 x 795 x 9	1,563 St pc	2 St pc	61,420 m ²		Bla UGL	R10/A+B	W138 (m ²)
430658			21,381 kg	1,280 m ²	27,360 kg		Bla UGL	R10/A+B	W138 (m ²)
430659							Bla UGL	R10/A+B	W138 (m ²)

Bodenfliese | carreau de sol | floor tile*

Feinsteinzeugplatten unglasiert | grès fin non-émaillés | porcelain stoneware tiles unglazed

80 x 80 cm



430655

graphite
strukturiert, matt
structuré, mat
structured, matt

430656

ash grey
strukturiert, matt
structuré, mat
structured, matt

430657

cement
strukturiert, matt
structuré, mat
structured, matt

430658

warm grey
strukturiert, matt
structuré, mat
structured, matt

430659

off white
strukturiert, matt
structuré, mat
structured, matt



* Achtung: Sonderpalette. Keine Rücknahme, kein Umtausch.

* Attention : palette spéciale. Pas de retour, pas d'échange.

* Please note: special pallet. No return, no exchange.

Art.	Nennmaß cote nominale nominal size cm	Herstellmaß cote de fabrication production size mm	m ²	Paket carton box	Palette palette pallet	Beanspr.-Gruppe groupe d'emploi wear resist. group	Norm Norme Standard	Trittsicherheit antidérapance non-slip	Preisgruppe groupe de prix price category
430660							Bla UGL	R10/A+B	W177 (m ²)
430661							Bla UGL	R10/A+B	W177 (m ²)
430662	120 x 120	1194 x 1194 x 9	0,694 St pc	2 St pc	57,637 m ²		Bla UGL	R10/A+B	W177 (m ²)
430663			21,098 kg	2,882 m ²	60,800 kg		Bla UGL	R10/A+B	W177 (m ²)
430664							Bla UGL	R10/A+B	W177 (m ²)



graphite



ash grey



cement



warm grey



off white



Bodenfliese | carreau de sol | floor tile*/**

Feinsteinzeugfliesen unglasiert | grès cérame fin vitrifié non-émaillés | porcelain stoneware tiles unglazed

120 x 120 cm



430660
graphite
strukturiert, matt
structuré, mat
structured, matt

430661
ash grey
strukturiert, matt
structuré, mat
structured, matt

430662
cement
strukturiert, matt
structuré, mat
structured, matt

430663
warm grey
strukturiert, matt
structuré, mat
structured, matt

430664
off white
strukturiert, matt
structuré, mat
structured, matt

* Achtung: Sonderpalette. Keine Rücknahme, kein Umtausch.
* Attention : palette spéciale. Pas de retour, pas d'échange.
* Please note: special pallet. No return, no exchange.

** Hohes Gewicht! Karton bitte nur zu Zweit transportieren.
** Poids élevé ; a transporter par deux personnes seulement.
** High weight only to carry with two persons.

Art.	Nennmaß cote nominale nominal size cm	Herstellmaß cote de fabrication production size mm	m ²	Paket carton box	Palette palette pallet	Beanspr.-Gruppe groupe d'emploi wear resist. group	Norm Norme Standard	Trittsicherheit antidérapance non-slip	Preisgruppe groupe de prix price category
430640							Bla UGL	R10/A+B	W303 (m ²)
430641							Bla UGL	R10/A+B	W303 (m ²)
430642	5 x 5	47 x 47 x 9	11,111 Bögen plaques sheets	12 Bögen plaques sheets	32,400 m ²		Bla UGL	R10/A+B	W303 (m ²)
430643			19,833 kg	1,080 m ² 21,420 kg	642,600 kg		Bla UGL	R10/A+B	W303 (m ²)
430644							Bla UGL	R10/A+B	W303 (m ²)

Mosaik | mosaïque | mosaic

Feinsteinzeugfliesen unglasiert | grès cérame fin vitrifié non-émaillés | porcelain stoneware tiles unglazed

5 x 5 cm

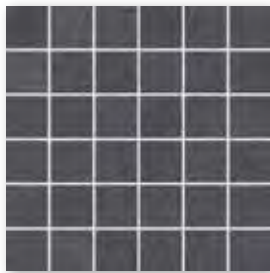

430640
graphite
strukturiert, matt
structuré, mat
structured, matt



430641
ash grey
strukturiert, matt
structuré, mat
structured, matt



430642
cement
strukturiert, matt
structuré, mat
structured, matt



430643
warm grey
strukturiert, matt
structuré, mat
structured, matt



430644
off white
strukturiert, matt
structuré, mat
structured, matt

Mosaik, Verklebung rückseitig auf Glasfasernetz
Bogen: 297 x 297 mm

Mosaïque, collée sur trame en fibre de verre à
l'envers, Feuille: 297 x 297 mm

Mosaic, glass fibre net on reverse side
Sheet: 297 x 297 mm

Art.	Nennmaß cote nominale nominal size cm	Herstellmaß cote de fabrication production size mm	m	Paket carton box	Palette palette pallet	Beanspr.-Gruppe groupe d'emploi wear resist. group	Norm Norme Standard	Trittsicherheit antidérapance non-slip	Preisgruppe groupe de prix price category
430635							Bla UGL	R10/A+B	W515 (St pc)
430636							Bla UGL	R10/A+B	W515 (St pc)
430637	30 x 44,5	297 x 442 x 9	3,236 St pc	2 St pc			Bla UGL	R10/A+B	W515 (St pc)
430638			5,191 kg	0,618 m	3,208 kg		Bla UGL	R10/A+B	W515 (St pc)
430639							Bla UGL	R10/A+B	W515 (St pc)

Dekorationselemente | éléments décoratifs | decoration elements

Bordüre Tweed | bordure Tweed | border Tweed

Feinsteinzeugfliesen unglasiert | grès cérame fin vitrifié non-émaillés | porcelain stoneware tiles unglazed

30 x 44,5 cm

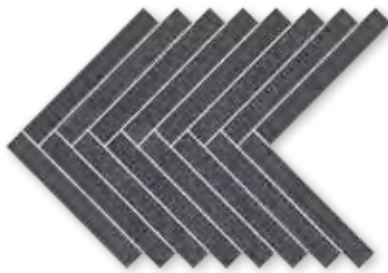

430635
graphite
strukturiert, matt
structuré, mat
structured, matt

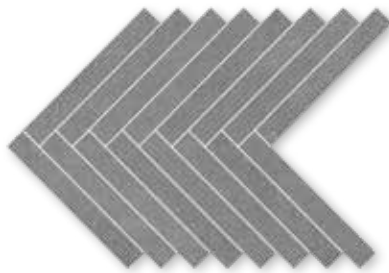

430636
ash grey
strukturiert, matt
structuré, mat
structured, matt



430637
cement
strukturiert, matt
structuré, mat
structured, matt

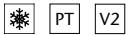

430638
warm grey
strukturiert, matt
structuré, mat
structured, matt



430639
off white
strukturiert, matt
structuré, mat
structured, matt

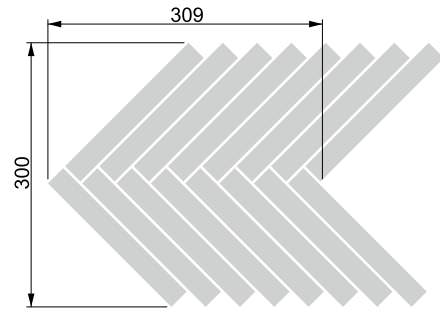

Bordüre, Verklebung rückseitig auf Glasfasernetz
Bogen: 297 x 442 mm
Border, collée sur trame en fibre de verre à
l'envers, Feuille: 297 x 442 mm
Bordure, glass fibre net on reverse side
Sheet: 297 x 442 mm

Abgabe der Dekorationselemente ausschließlich in vollen Kartons.
Éléments décoratifs uniquement livrables en cartons entiers.
Decoration elements only available in full boxes.

Art.	Nennmaß cote nominale nominal size cm	Herstellmaß cote de fabrication production size mm	m ²	Paket carton box	Palette palette pallet	Beanspr.-Gruppe groupe d'emploi wear resist. group	Norm Norme Standard	Trittsicherheit antidérapance non-slip	Preisgruppe groupe de prix price category
430665							Bla UGL	R11/B	W240 (m ²)
430666							Bla UGL	R11/B	W240 (m ²)
430667	60 x 60	596 x 596 x 20	2,778 St pc	2 St pc	21,598 m ²		Bla UGL	R11/B	W240 (m ²)
430668			47,226 kg	0,720 m ² 34,000 kg	1.020,000 kg		Bla UGL	R11/B	W240 (m ²)
430669							Bla UGL	R11/B	W240 (m ²)



graphite



ash grey



cement



warm grey



off white



Terrassenplatte | dalle de terrasse | patio tile*

Feinsteinzeugfliesen unglasiert | grès cérame fin vitrifié non-émaillés | porcelain stoneware tiles unglazed

60 x 60 cm



430665

graphite
strukturiert, matt
structuré, mat
structured, matt

430666

ash grey
strukturiert, matt
structuré, mat
structured, matt

430667

cement
strukturiert, matt
structuré, mat
structured, matt

430668

warm grey
strukturiert, matt
structuré, mat
structured, matt

430669

off white
strukturiert, matt
structuré, mat
structured, matt

* Hohes Gewicht! Karton bitte nur zu Zweit transportieren.
* Poids élevé ; a transporter par deux personnes seulement.
* High weight only to carry with two persons.

Art.	Nennmaß cote nominale nominal size cm	Herstellmaß cote de fabrication production size mm	m ²	Paket carton box	Palette palette pallet	Beanspr.-Gruppe groupe d'emploi wear resist. group	Norm Norme Standard	Trittsicherheit antidérapance non-slip	Preisgruppe groupe de prix price category
430670	120 x 120	1198 x 1198 x 20	0,694 St pc	1 St pc	28,560 m ²		Bla UGL	R11/B	W281 (m ²)
430671			46,567 kg	1,440 m ² 67,100 kg	1.342,000 kg		Bla UGL	R11/B	W281 (m ²)



graphite



cement



Terrassenplatte | dalle de terrasse | patio tile*/**

Feinsteinzeugfliesen unglasiert | grès cérame fin vitrifié non-émaillés | porcelain stoneware tiles unglazed

120 x 120 cm

**430670**graphite
strukturiert, matt
structuré, mat
structured, matt**430671**cement
strukturiert, matt
structuré, mat
structured, matt

* Achtung: Sonderpalette. Keine Rücknahme, kein Umtausch.
 * Attention : palette spéciale. Pas de retour, pas d'échange.
 * Please note: special pallet. No return, no exchange.

** Hohes Gewicht! Karton bitte nur zu Zweit transportieren.
 ** Poids élevé ; a transporter par deux personnes seulement.
 ** High weight only to carry with two persons.

Art.	Nennmaß cote nominale nominal size cm	Herstellmaß cote de fabrication production size mm	m	Paket carton box	Palette palette pallet	Beanspr.-Gruppe groupe d'emploi wear resist. group	Norm Norme Standard	Trittsicherheit antidérapance non-slip	Preisgruppe groupe de prix price category
430672							Bla UGL	R10/A+B	W473 (St pc)
430673							Bla UGL	R10/A+B	W473 (St pc)
430674	30 x 60	297 x 596 x 9	1,667 St pc	7 St pc			Bla UGL	R10/A+B	W473 (St pc)
430675			5,972 kg	4,199 m	25,081 kg		Bla UGL	R10/A+B	W473 (St pc)
430676							Bla UGL	R10/A+B	W473 (St pc)
430677							Bla UGL		W439 (St pc)
430678							Bla UGL		W439 (St pc)
430679	7 x 60	70 x 596 x 9	1,667 St pc	22 St pc			Bla UGL		W439 (St pc)
430680			1,357 kg	13,197 m	17,908 kg		Bla UGL		W439 (St pc)
430681							Bla UGL		W439 (St pc)



graphite



ash grey



cement



warm grey



off white



Treppenfliese | nez de marche | stair tile

Feinsteinzeugfliesen unglasiert | grès cérame fin vitrifié non-émaillés | porcelain stoneware tiles unglazed

30 x 60 cm



430672

graphite
strukturiert, matt
structuré, mat
structured, matt

430674

cement
strukturiert, matt
structuré, mat
structured, matt

430676

off white
strukturiert, matt
structuré, mat
structured, matt

430673

ash grey
strukturiert, matt
structuré, mat
structured, matt

430675

warm grey
strukturiert, matt
structuré, mat
structured, matt

Auftragsfertigung: Rückgabe
und/oder Stornierung bestellter
Ware nicht möglich.

Fabrication sur commande :
il nous est impossible d'accepter
l'annulation de commandes
d'articles ou le retour d'articles.

Make-to-order production:
return and/or cancellation of
ordered products not possible.

Sockel, gerundet | plinthe, arrondie | skirting, rounded

Feinsteinzeugfliesen unglasiert | grès cérame fin vitrifié non-émaillés | porcelain stoneware tiles unglazed

7 x 60 cm



430677

graphite
strukturiert, matt
structuré, mat
structured, matt

430679

cement
strukturiert, matt
structuré, mat
structured, matt

430681

off white
strukturiert, matt
structuré, mat
structured, matt

430678

ash grey
strukturiert, matt
structuré, mat
structured, matt

430680

warm grey
strukturiert, matt
structuré, mat
structured, matt

Natürliche Spielräume in der Gestaltung

Einzigartig in ihrer keramischen Komposition sowie mit Farbnuancen zwischen Anthrazit und Weiß macht sich die Lounge in jedem Raum hervorragend. Das Dekor Stone mit dezenter Marmor- und Steinoptik ist das Highlight jeder Raumgestaltung – auf großen oder kleinen Flächen. Die farbenfrohe Dekoration Garden entführt uns in die exotischen Gärten dieser Welt. Alle Fliesen sind Hytect-veredelt und besonders pflegeleicht.

Une liberté de conception naturelle

Unique dans sa composition céramique et avec des nuances de couleur entre l'anthracite et le blanc, Lounge s'intègre parfaitement dans chaque pièce. Avec son aspect discret de marbre et de pierre, le décor Stone est le point fort de tout aménagement de pièce – sur de grandes ou de petites surfaces. La décoration colorée Garden nous amène dans les jardins exotiques du monde entier. Tous les carreaux sont à finition Hytect et sont si faciles à entretenir.

Natural design scope

Unique in its ceramic composition and with color nuances between anthracite and white, the series Lounge looks fantastic in any room. The Stone decor with its discreet marble and stone look is the highlight of every room design – on large or small surfaces. The colorful Garden decoration whisks us away to the exotic gardens of this world. All tiles are Hytect-coated and thus easy to clean.





Art.	Nennmaß cote nominale nominal size cm	Herstellmaß cote de fabrication production size mm	m ²	Paket carton box	Palette palette pallet	Beanspr.-Gruppe groupe d'emploi wear resist. group	Norm Norme Standard	Trittsicherheit antidérapance non-slip	Preisgruppe groupe de prix price category
203392H	30 x 60	297 x 597 x 6	5,556 St pc	13 St pc	112,311 m ²		BIII GL		C89 (m ²)
203393H			10,279 kg	2,340 m ² 24,050 kg	1.154,400 kg		BIII GL		C89 (m ²)
323395H	30 x 90	297 x 897 x 6	3,704 St pc	8 St pc	51,836 m ²		BIII GL		C164 (m ²)
323396H			10,400 kg	2,160 m ² 22,464 kg	539,136 kg		BIII GL		C164 (m ²)

Wandfliese | carreau de mur | wall tile

Steingut glasiert | faïence émaillée | earthenware glazed

30 x 60 cm

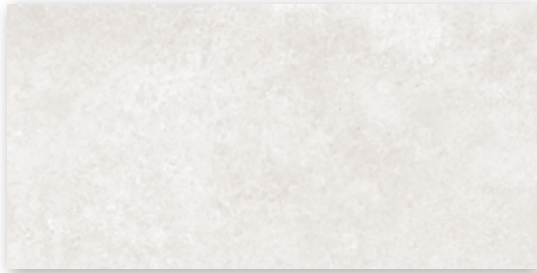

203392H

light taupe

strukturiert, seidenmatt | structuré, satiné | structured, silky-matt



203393H

grey white

strukturiert, seidenmatt | structuré, satiné | structured, silky-matt

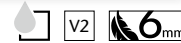

30 x 90 cm

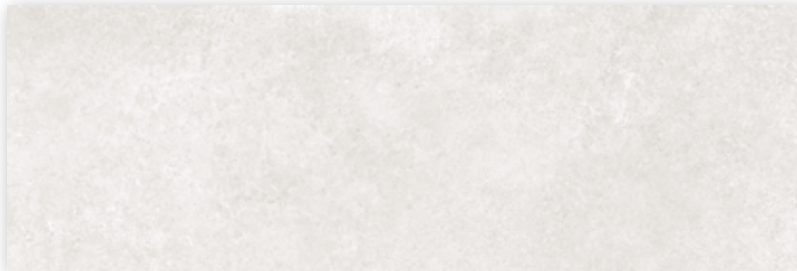

323395H

light taupe

strukturiert, seidenmatt | structuré, satiné | structured, silky-matt

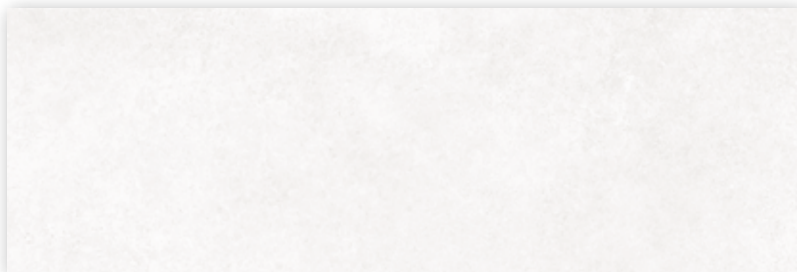

323396H

grey white

strukturiert, seidenmatt | structuré, satiné | structured, silky-matt

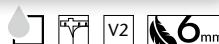

Art.	Nennmaß cote nominale nominal size cm	Herstellmaß cote de fabrication production size mm	m ²	Paket carton box	Palette palette pallet	Beanspr.-Gruppe groupe d'emploi wear resist. group	Norm Norme Standard	Trittsicherheit antidérapance non-slip	Preisgruppe groupe de prix price category
203394H	30 x 60	297 x 597 x 6	5,556 St pc 10,279 kg	13 St pc 2,340 m ² 24,050 kg	112,311 m ² 1.154,400 kg		BIII GL	C101 (m ²)	
323397H	30 x 90	297 x 897 x 6	3,704 St pc 10,400 kg	8 St pc 2,160 m ² 22,464 kg	51,836 m ² 539,136 kg		BIII GL	C170 (m ²)	

Dekorationselemente | éléments décoratifs | decoration elements

Dekorfliese Garden | carreau décoratif Garden | decorative element Garden

Steingut glasiert | faïence émaillée | earthenware glazed

30 x 60 cm



203394H

green mix

strukturiert, steinmatt | structuré, pierre mat | structured | stone-matt



Bei der von Ihnen ausgewählten Dekoration handelt es sich um ein hochwertiges Produkt aus Steingut glasiert. Die Dekoration besteht aus unterschiedlichen Einzelbildern. Die Anschlüsse der Einzelbilder sind bewusst frei gestaltet und verbinden sich somit nicht in der fortlaufenden Verlegung. Die Motivzusammenstellung im Karton kann produktionsbedingt variieren.

Le décor que vous avez choisi est un produit en faïence émaillée de grande qualité. Ce décor se compose d'images individuelles différentes. Les correspondances de chacune de ces images individuelles sont conçues de façon délibérément libre et ne se lient donc pas dans une pose continue. La combinaison de motifs dans le carton peut varier en fonction de la production.

The decoration you have chosen is a high-quality product made of glazed earthenware. The decoration consists of different individual pictures. The connections of the individual pictures are deliberately designed freely and thus do not connect in the continuous laying. The composition of the motifs in the box may vary due to production reasons.

Dekorfliese Stone | carreau décoratif Stone | decorative element Stone

Steingut glasiert | faïence émaillée | earthenware glazed

30 x 90 cm



323397H

grey mix

strukturiert, steinmatt | structuré, pierre mat | structured | stone-matt



Bei der von Ihnen ausgewählten Dekoration handelt es sich um ein hochwertiges Produkt aus Steingut glasiert. Die Dekoration besteht aus unterschiedlichen Einzelbildern. Die Anschlüsse der Einzelbilder sind bewusst frei gestaltet und verbinden sich somit nicht in der fortlaufenden Verlegung. Die Motivzusammenstellung im Karton kann produktionsbedingt variieren.

Le décor que vous avez choisi est un produit en faïence émaillée de grande qualité. Ce décor se compose d'images individuelles différentes. Les correspondances de chacune de ces images individuelles sont conçues de façon délibérément libre et ne se lient donc pas dans une pose continue. La combinaison de motifs dans le carton peut varier en fonction de la production.

The decoration you have chosen is a high-quality product made of glazed earthenware. The decoration consists of different individual pictures. The connections of the individual pictures are deliberately designed freely and thus do not connect in the continuous laying. The composition of the motifs in the box may vary due to production reasons.

Abgabe der Dekorationselemente ausschließlich in vollen Kartons.
Éléments décoratifs uniquement livrables en cartons entiers.
Decoration elements only available in full boxes.

Art.	Nennmaß cote nominale nominal size cm	Herstellmaß cote de fabrication production size mm	m ²	Paket carton box	Palette palette pallet	Beanspr.-Gruppe groupe d'emploi wear resist. group	Norm Norme Standard	Trittsicherheit antidérapance non-slip	Preisgruppe groupe de prix price category
431332H							Bla UGL	R10/A+B	C107 (m ²)
431333H	30 x 60	297 x 597 x 6	5,556 St pc	10 St pc	71,994 m ²		Bla UGL	R10/A+B	C107 (m ²)
431334H			13,273 kg	1,800 m ² 23,890 kg	955,600 kg		Bla UGL	R10/A+B	C107 (m ²)
431335H							Bla UGL	R10/A+B	C107 (m ²)
431336H							Bla UGL	R10/A+B	C119 (m ²)
431337H	60 x 60	597 x 597 x 6	2,778 St pc	5 St pc	64,795 m ²		Bla UGL	R10/A+B	C119 (m ²)
431338H			13,581 kg	1,800 m ² 24,445 kg	880,020 kg		Bla UGL	R10/A+B	C119 (m ²)
431339H							Bla UGL	R10/A+B	C119 (m ²)



dark taupe

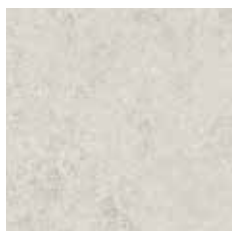

light sand



warm grey



dark anthracite



Bodenfliese | carreau de sol | floor tile

Feinsteinzeugfliesen unglasiert | grès cérame fin vitrifié non-émaillés | porcelain stoneware tiles unglazed

30 x 60 cm



431332H

dark taupe
strukturiert, matt
structuré, mat
structured, matt



431333H

light sand
strukturiert, matt
structuré, mat
structured, matt

431334H

warm grey
strukturiert, matt
structuré, mat
structured, matt

431335H

dark anthracite
strukturiert, matt
structuré, mat
structured, matt

60 x 60 cm



431336H

dark taupe
strukturiert, matt
structuré, mat
structured, matt



431337H

light sand
strukturiert, matt
structuré, mat
structured, matt

431338H

warm grey
strukturiert, matt
structuré, mat
structured, matt

431339H

dark anthracite
strukturiert, matt
structuré, mat
structured, matt

Art.	Nennmaß cote nominale nominal size cm	Herstellmaß cote de fabrication production size mm	m ²	Paket carton box	Palette palette pallet	Beanspr.-Gruppe groupe d'emploi wear resist. group	Norm Norme Standard	Trittsicherheit antidérapance non-slip	Preisgruppe groupe de prix price category
431340H							Bla UGL	R10/A+B	C149 (m ²)
431341H	60 x 120	597 x 1197 x 6	1,388 St pc	3 St pc	64,841 m ²		Bla UGL	R10/A+B	C149 (m ²)
431342H			14,088 kg	2,161 m ² 30,450 kg	913,500 kg		Bla UGL	R10/A+B	C149 (m ²)
431343H							Bla UGL	R10/A+B	C149 (m ²)

Bodenfliese | carreau de sol | floor tile

Feinsteinzeugfliesen unglasiert | grès cérame fin vitrifié non-émaillés | porcelain stoneware tiles unglazed

60 x 120 cm



431340H

dark taupe
strukturiert, matt
structuré, mat
structured, matt

431341H

light sand
strukturiert, matt
structuré, mat
structured, matt

431342H

warm grey
strukturiert, matt
structuré, mat
structured, matt

431343H

dark anthracite
strukturiert, matt
structuré, mat
structured, matt



Geeignet für den Einsatz in Bereichen mit Belastungsgruppe 1.
Se prête à l'utilisation dans les zones de la classe de sollicitation 1.
Suitable for the use in areas with stress group 1.

Art.	Nennmaß cote nominale nominal size cm	Herstellmaß cote de fabrication production size mm	m ²	Paket carton box	Palette palette pallet	Beanspr.-Gruppe groupe d'emploi wear resist. group	Norm Norme Standard	Trittsicherheit antidérapance non-slip	Preisgruppe groupe de prix price category
431344							Bla UGL	R10/A+B	C200 (m ²)
431345	120 x 120	1198 x 1198 x 6	0,694 St pc	2 St pc	69,124 m ²		Bla UGL	R10/A+B	C200 (m ²)
431346			14,100 kg	2,882 m ² 40,600 kg	974,400 kg		Bla UGL	R10/A+B	C200 (m ²)
431347							Bla UGL	R10/A+B	C200 (m ²)



dark taupe

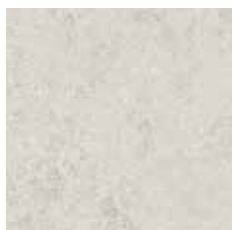

light sand



warm grey



dark anthracite



Bodenfliese | carreau de sol | floor tile*/**

Feinsteinzeugfliesen unglasiert | grès cérame fin vitrifié non-émaillés | porcelain stoneware tiles unglazed

120 x 120 cm

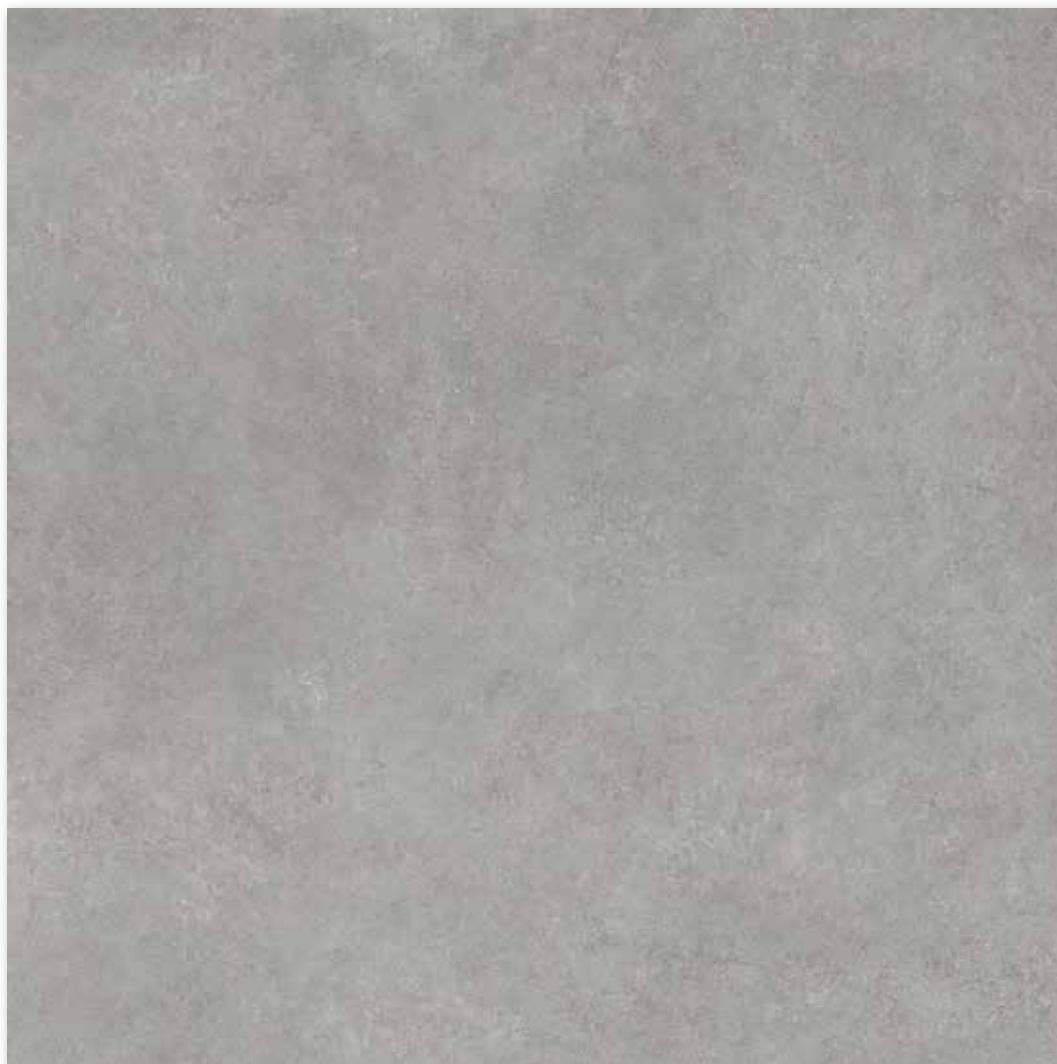

431344

dark taupe
strukturiert, matt
structuré, mat
structured, matt

431345

light sand
strukturiert, matt
structuré, mat
structured, matt

431346

warm grey
strukturiert, matt
structuré, mat
structured, matt

431347

dark anthracite
strukturiert, matt
structuré, mat
structured, matt

* Achtung: Sonderpalette. Keine Rücknahme, kein Umtausch.
* Attention : palette spéciale. Pas de retour, pas d'échange.
* Please note: special pallet. No return, no exchange.

** Hohes Gewicht! Karton bitte nur zu Zweit transportieren.
** Poids élevé ; a transporter par deux personnes seulement.
** High weight only to carry with two persons.

Art.	Nennmaß cote nominale nominal size cm	Herstellmaß cote de fabrication production size mm	m/m ²	Paket carton box	Palette palette pallet	Beanspr.-Gruppe groupe d'emploi wear resist. group	Norm Norme Standard	Trittsicherheit antidérapance non-slip	Preisgruppe groupe de prix price category
431348H							Bla UGL		C437 (St pc)
431349H	7 x 60	70 x 597 x 6	1,667 St/m	38 St pc			Bla UGL		C437 (St pc)
431350H			0,938 kg/m	22,795 m	21,394 kg		Bla UGL		C437 (St pc)
431351H							Bla UGL		C437 (St pc)
431328H							Bla UGL	R10/A+B	C341 (m ²)
431329H	5 x 5	47 x 47 x 6	11,111 Bögen plaques sheets	11 Bögen plaques sheets	35,640 m ²		Bla UGL	R10/A+B	C341 (m ²)
431330H			11,488 kg/m ²	0,990 m ²	11,374 kg	409,464 kg	Bla UGL	R10/A+B	C341 (m ²)
431331H							Bla UGL	R10/A+B	C341 (m ²)

Sockel, geschnitten | plinthe, à bord vif | skirting, cut

Feinsteinzeugfliesen unglasiert | grès cérame fin vitrifié non-émaillés | porcelain stoneware tiles unglazed

7 x 60 cm



431348H

dark taupe
strukturiert, matt | structuré, mat | structured, matt

431349H

light sand
strukturiert, matt | structuré, mat | structured, matt

431350H

warm grey
strukturiert, matt | structuré, mat | structured, matt

431351H

dark anthracite
strukturiert, matt | structuré, mat | structured, matt

Mosaik | mosaïque | mosaic

Feinsteinzeugfliesen unglasiert | grès cérame fin vitrifié non-émaillés | porcelain stoneware tiles unglazed

5 x 5 cm

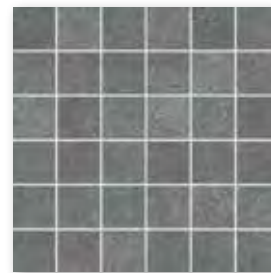

431328H

dark taupe
strukturiert, matt
structuré, mat
structured, matt

431329H

light sand
strukturiert, matt
structuré, mat
structured, matt

431330H

warm grey
strukturiert, matt
structuré, mat
structured, matt

431331H

dark anthracite
strukturiert, matt
structuré, mat
structured, matt

Mosaik, Verklebung rückseitig auf Glasfasernetz
Bogen: 297 x 297 mm

Mosaïque, collée sur trame en fibre de verre à l'envers, Feuille: 297 x 297 mm

Mosaic, glass fibre net on reverse side
Sheet: 297 x 297 mm

Geeignet für den Einsatz in Bereichen mit Belastungsgruppe 1.
Se prête à l'utilisation dans les zones de la classe de sollicitation 1.
Suitable for the use in areas with stress group 1.

Unverwechselbarer Charakter

Manuell gestaltete Harzplatten sind die Ausgangsbasis der Serie Lunar. Die entstandenen unregelmäßigen Streifen geben den Fliesen ihren eigenen Ausdruck. Das Design der Basisfliesen ist schlicht mit markanten Details, so entsteht auf den Wand- und Bodenflächen (basalt, marrone, anthrazit) eine ganz besondere Optik. Ob eher reduziert oder natürlich, mit den Farbstellungen der Dekorfliese Planets als Ergänzung zu der cremegrauen Wandfliese ist beides möglich – ganz nach persönlichem Gusto.

Caractère distinctif

Les panneaux en résine conçus manuellement sont le point de départ de la série Lunar. Les rayures irrégulières qui en résultent donnent aux carreaux leur propre expression. Le design des carreaux de base est simple avec des détails frappants, créant un aspect très spécial sur les surfaces des murs et des sols (basalte, marrone, anthracite). Les couleurs du carreau décoratif Planètes, lorsqu'il complète le carreau mural gris crème, permet les deux effets : « réduction » ou « nature » – en fonction de vos goûts personnels.

Distinctive character

Manually designed resin tiles are the starting basis for the Lunar series. The resulting irregular stripes give the tiles their own expression. The design of the basic tiles is simple with striking details, thus creating a very special look on the wall and floor surfaces (basalt, maroon, anthracite). Whether rather reduced or natural, with the colours of the Planets decorative tile as a complement to the cream-grey wall tile, both are possible – according to personal taste.





Art.	Nennmaß cote nominale nominal size cm	Herstellmaß cote de fabrication production size mm	m ²	Paket carton box	Palette palette pallet	Beanspr.-Gruppe groupe d'emploi wear resist. group	Norm Norme Standard	Trittsicherheit antidérapance non-slip	Preisgruppe groupe de prix price category
283005	30 x 60	297 x 597 x 9	5,556 St pc 14,946 kg	9 St pc 1,620 m ² 24,210 kg	77,754 m ² 1.162,080 kg		BIII GL		C107 (m ²)
393006	30 x 90	297 x 897 x 10,5	3,704 St pc 17,976 kg	5 St pc 1,350 m ² 24,265 kg	32,397 m ² 582,360 kg		BIII GL		C179 (m ²)

Wandfliese | carreau de mur | wall tile
Steingut glasiert | faïence émaillée | earthenware glazed

30 x 60 cm

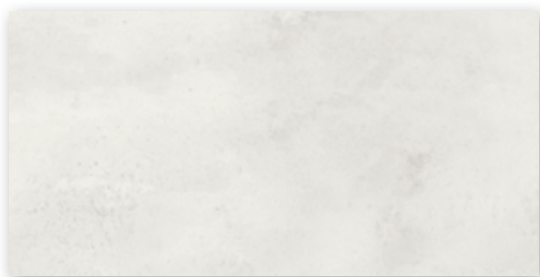

283005

cremegrau | gris crème | cream-grey
eben, seidenmatt | satiné, lisse | smooth, silky-matt

30 x 90 cm



393006

cremegrau | gris crème | cream-grey
eben, seidenmatt | satiné, lisse | smooth, silky-matt

Art.	Nennmaß cote nominale nominal size cm	Herstellmaß cote de fabrication production size mm	m	Paket carton box	Palette palette pallet	Beanspr.-Gruppe groupe d'emploi wear resist. group	Norm Norme Standard	Trittsicherheit antidérapance non-slip	Preisgruppe groupe de prix price category
283007	7,5 x 30	72 x 297 x 9	3,333 St pc	12 St pc			BIII GL		C412 (St pc)
283008			1,077 kg	3,600 m 3,876 kg			BIII GL		C412 (St pc)

Dekorationselemente | éléments décoratifs | decoration elements

Dekorfliese Planets | carreau décoratif Planets | decorative element Planets

Steingut glasiert | faïence émaillée | earthenware glazed

7,5 x 30 cm

Verlegebeispiele | modèles de pose | laying examples



Die Dekorriegel variieren bewusst in der Farbigkeit. Bitte gemischt aus mehreren Kartons verlegen, damit sich ein gleichmäßiges Bild ergibt.

La variation des couleurs des traverses décoratives est voulue. Nous recommandons de poser les carreaux en mélangeant plusieurs cartons afin d'obtenir une impression régulière.

The colors of the decoration elements Planets intentionally vary. We recommend the mixed laying of elements from several boxes in order to obtain a uniform result.

283007

weiß-grau-mix | mélange blanc gris | white-grey-mix
strukturiert, seidenmatt | structuré, satiné | structured, silky-matt



283008

beige-braun-mix | mélange beige-brun | beige-brown-mix
strukturiert, seidenmatt | structuré, satiné | structured, silky-matt

Abgabe der Dekorationselemente ausschließlich in vollen Kartons.
Éléments décoratifs uniquement livrables en cartons entiers.
Decoration elements only available in full boxes.

Natürlich und lässig

Regen verändert Holz im Laufe der Zeit. In der Oberfläche entstehen neue Strukturen, Effekte und von der Witterung geprägte Farben. Die Farbkarte von Mandalay umfasst helle Creme-Brauntöne, mit Grau durchmischte Braunnuancen und dunkles Braun mit Anthrazit. Die Bodenfliese überzeugt durch ihre natürliche und lässige Anmutung. Der gewollten Used Look berücksichtigt natürliche Gebrauchsspuren und zarte Verfärbungen. Die Wandfliese ist eine Kollage aus streifigen Maserungen und freien Pinselstrichen. Durch Überlagerungen und Überkreuzungen entsteht eine richtungsfreie Optik die besonders in der Farbstellung weiß-bunt ihren künstlerischen Charakter entfaltet.

Naturel et décontracté

La pluie modifie le bois au fil du temps. De nouvelles structures, de nouveaux effets et de nouvelles couleurs influencées par le temps sont créés sur la surface. Le nuancier de Mandalay comprend des bruns clairs et crémeux, des bruns mélangés à du gris et des bruns foncés avec de l'anthracite. Le carreau de sol convainc grâce à son flair naturel et décontracté. L'aspect usagé délibéré « Used Look » tient compte des traces naturelles d'utilisation et de la délicate décoloration. Le carreau de mur est un collage de veinures rayées et de coups de pinceau à main libre. Les superpositions et les croisements créent un look non directionnel qui déploie son caractère artistique, notamment dans le schéma de couleurs blanc-multicolore.

Natural and casual

Rain changes wood over time. New structures, effects and weathered colours are created on the surface. Mandalay's colour card includes light cream-brown shades, brown shades mixed with grey and dark brown with anthracite. The floor tile convinces with its natural and casual look. The intended used look takes into account natural signs of wear and delicate discolouration. The wall tile is a collage of striped grains and free brush strokes. Overlays and crossings create a non-directional look that unfolds its artistic character especially in the colour scheme white and colourful.





Art.	Nennmaß cote nominale nominal size cm	Herstellmaß cote de fabrication production size mm	m ² /m	Paket carton box	Palette palette pallet	Beanspr.-Gruppe groupe d'emploi wear resist. group	Norm Norme Standard	Trittsicherheit antidérapance non-slip	Preisgruppe groupe de prix price category
282901	30 x 60	297 x 597 x 9	5,556 St pc / m ²	9 St pc	77,754 m ²		BIII GL	C107 (m ²)	
282902			14,946 kg	1,620 m ² 24,210 kg	1.162,080 kg		BIII GL	C107 (m ²)	
282903	4 x 60	37 x 597 x 10,5	1,667 St pc / m	3 St pc			Bla UGL	C447 (St pc)	
			0,910 kg	1,800 m 1,638 kg					

Wandfliese | carreau de mur | wall tile
Steingut glasiert | faïence émaillée | earthenware glazed

30 x 60 cm



V2

282901
naturweiß | blanc nature | natural-white
eben, seidenmatt | lisse, satiné | smooth, silky-matt



V4

282902
weiß-bunt | blanc multicolore | white-colorful
eben, seidenmatt | lisse, satiné | smooth, silky-matt

Dekorationselemente | éléments décoratifs | decoration elements

Bordüre Canvas | bordure Canvas | border Canvas

Feinsteinzeugfliesen unglasiert | grès cérame fin vitrifié non-émaillés | porcelain stoneware tiles unglazed

4 x 60 cm

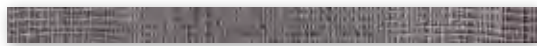

V3

Nur für die Verlegung an der Wand im Innenbereich geeignet.
Convient uniquement pour une pose murale en intérieur.
Only suitable for laying on the wall in indoor areas.

282903
grau-schwarz | noir gris | grey-black
strukturiert, matt | structuré, mat | structured, matt







Herr der Gezeiten – Zeit für Inspiration

Mando verleiht einem Bad ein helles und luftiges, an Sand, Treibgut und Wind erinnerndes Ambiente. Matt- oder glänzend-weiße Wandfliesen in 35 x 100 cm schaffen einen klaren Rahmen für das Volldekor Spirit im gleichen Format – in grau-blau matt oder creme-cotto matt. Ein weiteres optisches Highlight in korrespondierenden Farben: das Riegel-Dekor Cabana mit Holz-Mix-Optik in 8,45 x 33 cm. In diese Gesamtidee von authentischer Natürlichkeit fügt sich die Vintage-Holz-Serie Walden als Boden harmonisch ein. Alle Fliesen von Mando sind aufgrund ihrer Hytect-Oberfläche reinigungsfreundlich.

Le Prince des marées, l'heure de l'inspiration

Mando donne à la salle de bain une ambiance claire et aérée qui rappelle le sable, les débris flottants et le vent. Les carreaux muraux blancs, mats ou brillants, de 35 x 100 cm, créent les conditions parfaites pour un esprit de décor absolu, en mat gris-bleu ou crème-cotto. Un autre atout visuel aux coloris assortis sont les carreaux transversaux Cabana d'aspect bois en 8,45 x 33 cm. La série en bois vintage Walden pour le sol complète harmonieusement l'idée globale de nature authentique. Tous les carreaux de Mando sont faciles à nettoyer grâce à leur surface Hytect.

The prince of tides – time for inspiration

Mando lends bathrooms a bright and airy ambience reminiscent of sand, Walden and wind. Matt or glossy white wall tiles in 35 x 100 cm create a clear framework for the Spirit full decor of the same size – in grey-blue matt or cream-cotto matt. Another visual highlight in matching colors: the Cabana strip decor with a wood mix look in 8.45 x 33 cm. The Walden vintage wood series harmoniously integrates as a floor in this overall idea of authentic naturalness. All Mando tiles are easy to clean thanks to their Hytect surface.

Art.	Nennmaß cote nominale nominal size cm	Herstellmaß cote de fabrication production size mm	m ² /m	Paket carton box	Palette palette pallet	Beanspr.-Gruppe groupe d'emploi wear resist. group	Norm Norme Standard	Trittsicherheit antidérapance non-slip	Preisgruppe groupe de prix price category
363347H	35 x 100	347 x 997 x 6	2,857 St pc / m ²	5 St pc	70,000 m ²		BIII GL		W156 (m ²)
363348H			10,108 kg	1,750 m ² 17,690 kg	707,600 kg		BIII GL		W156 (m ²)
363351H	8,45 x 33	84,5 x 330 x 6	3,030 St pc / m	18 St pc			BIII GL		W421 (St pc)
			0,878 kg	5,940 m 5,220 kg					

Wandfliese | carreau de mur | wall tile

Steingut glasiert | faïence émaillée | earthenware glazed

35 x 100 cm

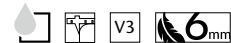

363347H

weiß glänzend | blanc brillant | white glossy
eben | lisse | smooth

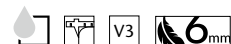

363348H

weiß matt | blanc mat | white matt
eben | lisse | smooth

Dekorationselemente | éléments décoratifs | decoration elements

Dekorfliese Cabana | carreau décoratif Cabana | decorative element Cabana

Steingut glasiert | faïence émaillée | earthenware glazed

Verlegebeispiele | Exemples de pose | laying examples

8,45 x 33 cm

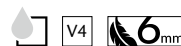

363351H

braun-mix | mélange marron | brown-mix
eben, seidenmatt | lisse, satiné | smooth, silky-matt

Die Riegel Cabana variieren bewusst in der Farbigkeit. Bitte gemischt aus mehreren Kartons verlegen, damit sich ein gleichmäßiges Bild ergibt.

Les couleurs des carreaux transversaux Cabana varient volontairement. Veuillez mélanger plusieurs cartons lors de la pose pour obtenir un résultat uniforme.

The Cabana strips consciously vary in terms of color. Please combine tiles from several boxes to provide a consistent appearance.

Abgabe der Dekorationselemente ausschließlich in vollen Kartons.
Éléments décoratifs uniquement livrables en cartons entiers.
Decoration elements only available in full boxes.

Art.	Nennmaß cote nominale nominal size cm	Herstellmaß cote de fabrication production size mm	m	Paket carton box	Palette palette pallet	Beanspr.-Gruppe groupe d'emploi wear resist. group	Norm Norme Standard	Trittsicherheit antidérapance non-slip	Preisgruppe groupe de prix price category
363349H	35 x 100	347 x 997 x 6	1,000 St pc 3,538 kg	3 St pc 3,000 m 10,614 kg			BIII GL		3 x W499 (St pc)

Dekorationselemente | éléments décoratifs | decoration elements

Dekorfliese Spirit | carreau décoratif Spirit | decorative element Spirit

Steingut glasiert | faïence émaillée | earthenware glazed

35 x 100 cm

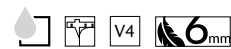

363349H

grau-blau | gris bleu | grey-blue
eben, seidenmatt | lisse, satiné | smooth, silky-matt
3er-Set | jeu de 3 carreaux | set of 3 tiles

Abgabe der Dekorationselemente ausschließlich in vollen Kartons.
Eléments décoratifs uniquement livrables en cartons entiers.
Decoration elements only available in full boxes.

Bodenempfehlung Serie Walden, siehe Seite 672.
Recommandation relative au sol, série Walden, voir page 672.
Recommended floor tiles: series Walden, see page 672.

Art.	Nennmaß cote nominale nominal size cm	Herstellmaß cote de fabrication production size mm	m	Paket carton box	Palette palette pallet	Beanspr.-Gruppe groupe d'emploi wear resist. group	Norm Norme Standard	Trittsicherheit antidérapance non-slip	Preisgruppe groupe de prix price category
363350H	35 x 100	347 x 997 x 6	1,000 St pc 3,538 kg	3 St pc 3,000 m 10,614 kg			BIII GL		3 x W499 (St pc)

Dekorationselemente | éléments décoratifs | decoration elements

Dekorfliese Spirit | carreau décoratif Spirit | decorative element Spirit

Steingut glasiert | faïence émaillée | earthenware glazed

35 x 100 cm

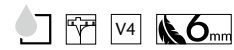

363350H

creme-cotto | crème-cotto | cream-cotto
eben, seidenmatt | lisse, satiné | smooth, silky-matt
3er-Set | jeu de 3 carreaux | set of 3 tiles

Abgabe der Dekorationselemente ausschließlich in vollen Kartons.
Éléments décoratifs uniquement livrables en cartons entiers.
Decoration elements only available in full boxes.

Bodenempfehlung Serie Walden, siehe Seite 672.
Recommandation relative au sol, série Walden, voir page 672.
Recommended floor tiles: series Walden, see page 672.



Studioaufnahme · photo prise en studio · studio photo / Architekt · architecte · architect: STELLWERK architekten, Dresden, Deutschland · Allemagne · Germany / Serie · série · series: Mando / Photo: Jochen Stüber



Wunderbar wandelbares Weiß

Puristische Klarheit? Entspannendes Naturambiente? Bei Modern White machen die Dekorelemente den Unterschied. Je nach Wahl harmoniert die perlweiß glänzende Wandfliese mit einer großen Bandbreite von Einrichtungsstilen. Lieferbar ist eine Bordüre, die schwarzem Sahara-Marmor nachempfunden ist, dazu eine weniger kontrastreiche Variante in ruhigen Grautönen. Die Dekorrichtung „Botanic“ bringt ein Stück exotische Natur in das eigene Zuhause. Ein Glanzdruck in Blätteroptik, der auf die seidigmatte Fliesenoberfläche gedruckt wird, schafft eine elegante Verbindung zur glänzenden Basisfliese der Serie.

Un blanc merveilleusement changeant

Clarté épurée ? Ambiance naturelle relaxante ? Avec Modern White, ce sont les éléments décoratifs qui font la différence. Selon votre choix, le carrelage mural blanc nacré s'associera harmonieusement avec un large éventail de styles de décoration intérieure. La gamme comporte une bordure, inspirée du marbre noir du Sahara, ainsi qu'une variante moins contrastée déclinée dans des teintes apaisées de gris. Le style décoratif « Botanic » apporte aux espaces intérieurs une touche de nature exotique. Un motif de feuille imprimé en surbrillance sur la surface mate et soyeuse des carreaux crée un lien élégant avec le carreau de base brillant de la collection.

Wonderfully transformative white

Purist clarity? Relaxing natural ambience? Decorative elements make the difference in the Modern White range. Depending on the selection, the shimmering pearl white wall tile harmonises with a wide range of interior styles. A border is available which is based on black Sahara marble and another less contrasting variant in calm shades of grey. The "Botanic" decorative style adds an exotic touch to any home. A glossy print in leaf optic which is printed on the silky-matt tile surface creates an elegant linking element to the glossy basic tiles in the range.

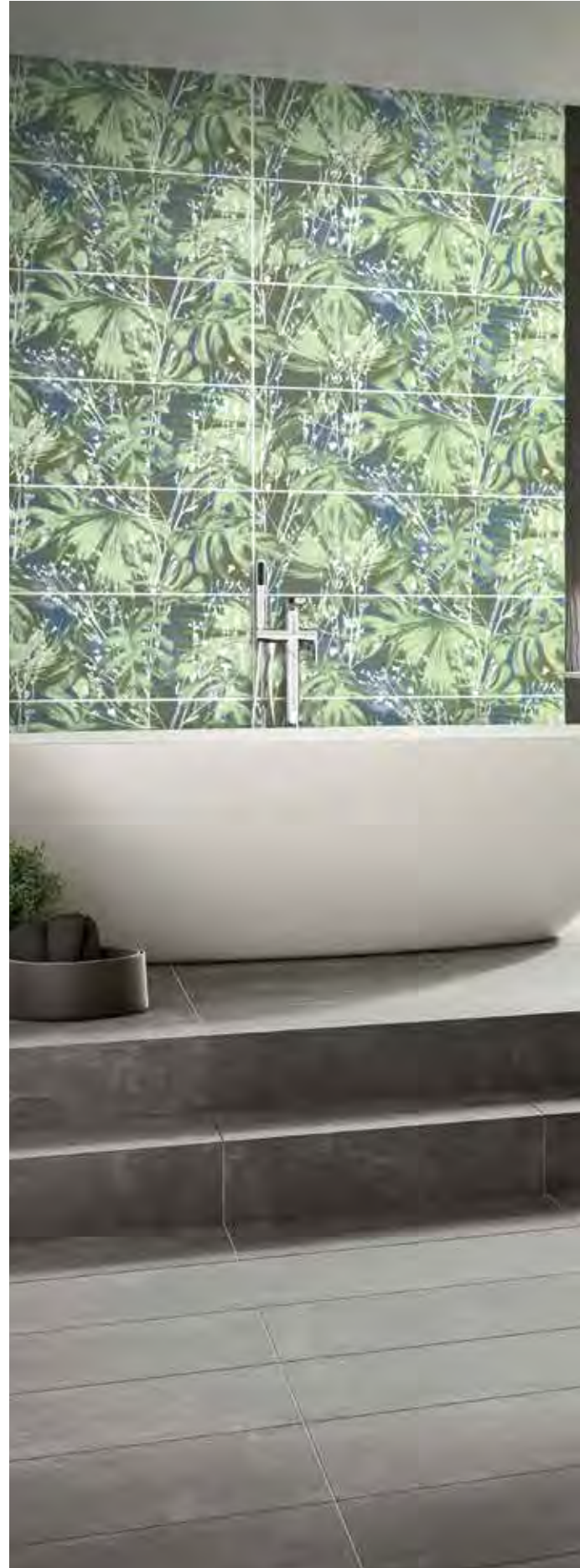



Art.	Nennmaß cote nominale nominal size cm	Herstellmaß cote de fabrication production size mm	m ²	Paket carton box	Palette palette pallet	Beanspr.-Gruppe groupe d'emploi wear resist. group	Norm Norme Standard	Trittsicherheit antidérapance non-slip	Preisgruppe groupe de prix price category
283047H	30 x 60	297 x 597 x 9	5,556 St pc 14,946 kg	9 St pc 1,620 m ² 24,210 kg	77,754 m ² 1.162,080 kg		BIII GL	W90 (m ²)	
393050H	30 x 90	297 x 897 x 10,5	3,704 St pc 17,976 kg	5 St pc 1,350 m ² 24,265 kg	32,397 m ² 582,360 kg		BIII GL	W162 (m ²)	

Wandfliese | carreau de mur | wall tile

Steingut glasiert | faïence émaillée | earthenware glazed

30 x 60 cm

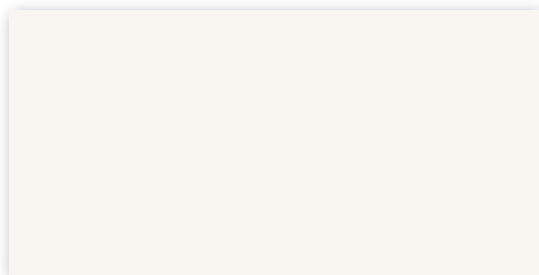

283047H

perlweiß, glänzend | blanc perle, brillant | pearl-white, glossy
eben, glänzend | lisse, brillant | smooth, glossy

30 x 90 cm

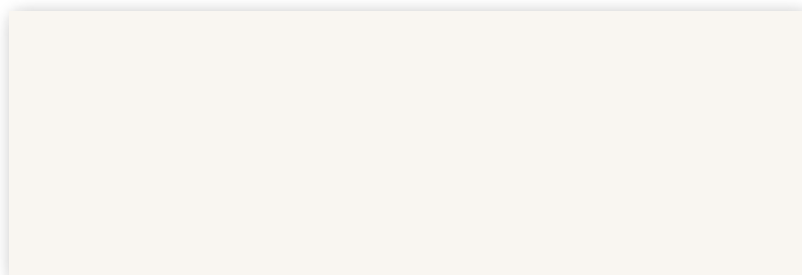

393050H

perlweiß, glänzend | blanc perle, brillant | pearl-white, glossy
eben, glänzend | lisse, brillant | smooth, glossy

Art.	Nennmaß cote nominale nominal size cm	Herstellmaß cote de fabrication production size mm	m	Paket carton box	Palette palette pallet	Beanspr.-Gruppe groupe d'emploi wear resist. group	Norm Norme Standard	Trittsicherheit antidérapance non-slip	Preisgruppe groupe de prix price category
283048H	10 x 60	97 x 597 x 9	1,667 St pc	6 St pc			BIII GL		W421 (St pc)
283049H			1,409 kg	3,600 m	5,070 kg		BIII GL		W421 (St pc)
393051H	10 x 90	97 x 897 x 10,5	1,111 St pc	6 St pc			BIII GL		W432 (St pc)
393052H			1,744 kg	5,400 m	9,420 kg		BIII GL		W432 (St pc)

Dekorationselemente | éléments décoratifs | decoration elements

Bordüre | bordure | border

Steingut glasiert | faïence émaillée | earthenware glazed

10 x 60 cm

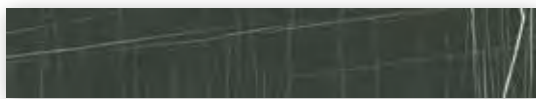

283048H

schwarz | noir | black
eben, seidenmatt | lisse, satinée | smooth, silky-matt



283049H

basaltgrau | gris basalte | basalt-grey
eben, seidenmatt | lisse, satinée | smooth, silky-matt



10 x 90 cm

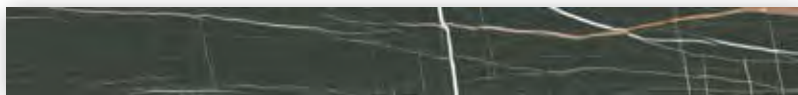

393051H

schwarz | noir | black
eben, seidenmatt | lisse, satinée | smooth, silky-matt



393052H

basaltgrau | gris basalte | basalt-grey
eben, seidenmatt | lisse, satinée | smooth, silky-matt



Abgabe der Dekorationselemente ausschließlich in vollen Kartons.
Éléments décoratifs uniquement livrables en cartons entiers.
Decoration elements only available in full boxes.

Art.	Nennmaß cote nominale nominal size cm	Herstellmaß cote de fabrication production size mm	m	Paket carton box	Palette palette pallet	Beanspr.-Gruppe groupe d'emploi wear resist. group	Norm Norme Standard	Trittsicherheit antidérapance non-slip	Preisgruppe groupe de prix price category
283113H	30 x 60	297 x 597 x 9	1,667 St pc	2 St pc			BIII GL		2 x W424 (St pc)
283114H			4,484 kg	1,200 m 5,380 kg			BIII GL		2 x W424 (St pc)

Dekorationselemente | éléments décoratifs | decoration elements

Dekorfliese Botanic | carreau décoratif Botanic | decorative element Botanic

Steingut glasiert | faïence émaillée | earthenware glazed

30 x 60 cm



283113H
 tropical garden
 eben, seidenmatt | lisse, satinée | smooth, silky-matt
 2er-Set | jeu de 2 carreaux | set of 2 tiles



283114H
 urban garden
 eben, seidenmatt | lisse, satinée | smooth, silky-matt
 2er-Set | jeu de 2 carreaux | set of 2 tiles



Abgabe der Dekorationselemente ausschließlich in vollen Kartons.
 Éléments décoratifs uniquement livrables en cartons entiers.
 Decoration elements only available in full boxes.

Bodenempfehlung Serien Soul (Seite 646), Oak (Seite 606).
 Recommandation de carreaux de sol, séries Soul (page 646), Oak (page 606).
 Recommended floor tiles: series Soul (page 646), Oak (page 606).

Art.	Nennmaß cote nominale nominal size cm	Herstellmaß cote de fabrication production size mm	m	Paket carton box	Palette palette pallet	Beanspr.-Gruppe groupe d'emploi wear resist. group	Norm Norme Standard	Trittsicherheit antidérapance non-slip	Preisgruppe groupe de prix price category
393115H	30 x 90	297 x 897 x 10,5	1,111 St pc	2 St pc			BIII GL		2 x W462 (St pc)
393116H			5,392 kg	1,800 m 9,706 kg			BIII GL		2 x W462 (St pc)

Dekorationselemente | éléments décoratifs | decoration elements

Dekorfliese Botanic | carreau décoratif Botanic | decorative element Botanic

Steingut glasiert | faïence émaillée | earthenware glazed

30 x 90 cm



393115H

tropical garden
eben, seidenmatt | lisse, satinée | smooth, silky-matt
2er-Set | jeu de 2 carreaux | set of 2 tiles



393116H

urban garden
eben, seidenmatt | lisse, satinée | smooth, silky-matt
2er-Set | jeu de 2 carreaux | set of 2 tiles

Abgabe der Dekorationselemente ausschließlich in vollen Kartons.
Éléments décoratifs uniquement livrables en cartons entiers.
Decoration elements only available in full boxes.

Bodenempfehlung Serien Soul (Seite 646), Oak (Seite 606).
Recommandation de carreaux de sol, séries Soul (page 646), Oak (page 606).
Recommended floor tiles: series Soul (page 646), Oak (page 606).

Pflegeleichter Holz-Look

Mit Oak gelingt eine elegante und raffinierte Holzoptik – in Eiche natur oder Eiche anthrazit. Die Bodenserie verfügt über 5 Formatvarianten, Treppenelemente, Sockel sowie ein 6-eckiges Bodendekor mit 30 x 35 cm – alle mit Hytect-Oberfläche – für viel Gestaltungsspielraum im einheitlichen Look. Für modernen Touch sorgen drei Paneelen-Formate mit 30 x 120, 40 x 120 und 60 x 120 cm. Durch die großen Formate kommt die Maserung besonders gut zur Geltung. Als passende Bordüre empfiehlt sich die aus Oak geschnittene Dekoration „Verso“ der Serie Sky (siehe Seite 632).

Aspect bois sans entretien

Décliné dans les teintes chêne nature et chêne anthracite, Oak et son effet bois apportent élégance et raffinement. Avec des carreaux de sol en 5 formats différents, des carreaux d'escalier, des plinthes et un élément de décoration hexagonal de 30 x 35 cm – tous avec surface Hytect – la gamme offre une grande liberté conceptuelle pour un aménagement harmonisé. Trois formats de lambris de 30 x 120, 40 x 120 et 60 x 120 cm apportent une touche de modernité. Ces grands formats mettent particulièrement en valeur les veinures du motif bois. La bordure assortie « Verso » est un élément de décoration issu de la gamme Sky (voir page 632).

Easy-care wood look

Oak achieves an elegant and refined wood look – natural or anthracite variants. The floor series offers 5 different sizes, stair elements, skirtings and a hexagonal floor décor in 30 x 35 cm – all of them with Hytect surface – for plenty of design freedom with a uniform appearance. A modern touch is provided by three panel sizes measuring 30 x 120, 40 x 120 and 60 x 120 cm. These large formats show the grain at its best advantage. The “Verso” décor cut from Oak in the Sky series is recommended as a matching border (see page 632).





Art.	Nennmaß cote nominale nominal size cm	Herstellmaß cote de fabrication production size mm	m ²	Paket carton box	Palette palette pallet	Beanspr.-Gruppe groupe d'emploi wear resist. group	Norm Norme Standard	Trittsicherheit antidérapance non-slip	Preisgruppe groupe de prix price category
8471-B695HK	15 x 90	147 x 897 x 8	7,407 St pc	8 St pc	43,202 m ²		Alb UGL	R10/A	W171 (m ²)
8472-B695HK			17,495 kg	1,081 m ² 18,896 kg	755,840 kg		Alb UGL	R10/A	W171 (m ²)
8471-B690HK	30 x 90	297 x 897 x 8	3,704 St pc	5 St pc	40,497 m ²		Alb UGL	R10/A	W162 (m ²)
8472-B690HK			17,501 kg	1,350 m ² 23,625 kg	708,750 kg		Alb UGL	R10/A	W162 (m ²)



Eiche natur
chêne nature
natural oak

V4



Eiche anthrazit
chêne anthracite
anthracite oak

V3

Bodenfliese | carreau de sol | floor tile

Feinsteinzeugplatten unglasiert | grès fin non-émaillés | porcelain stoneware tiles unglazed

15 x 90 cm Riegelformat | format de traverse | oblong format

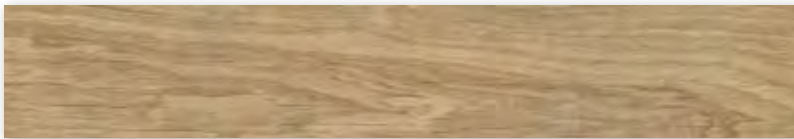

Auftragsfertigung Riegelformat:
Rückgabe und/oder Stornierung
bestellter Ware nicht möglich.

Fabrication sur commande des
formats en traverse : il nous est
impossible d'accepter l'annulation
de commandes d'articles ou
le retour d'articles.

Make-to-order production in
the case of oblong formats:
return and/or cancellation of
ordered products not possible.

8471-B695HK

Eiche natur | chêne nature | natural oak
strukturiert, matt | structuré, mat | structured, matt

8472-B695HK

Eiche anthrazit | chêne anthracite | anthracite oak
strukturiert, matt | structuré, mat | structured, matt

30 x 90 cm



8471-B690HK

Eiche natur | chêne nature | natural oak
strukturiert, matt | structuré, mat | structured, matt

8472-B690HK

Eiche anthrazit | chêne anthracite | anthracite oak
strukturiert, matt | structuré, mat | structured, matt

Art.	Nennmaß cote nominale nominal size cm	Herstellmaß cote de fabrication production size mm	m ²	Paket carton box	Palette palette pallet	Beanspr.-Gruppe groupe d'emploi wear resist. group	Norm Norme Standard	Trittsicherheit antidérapance non-slip	Preisgruppe groupe de prix price category
8471-B620HK	30 x 120	297 x 1197 x 8	2,778 St pc	4 St pc	43,197 m ²		Alb UGL	R10/A	W171 (m ²)
8472-B620HK			17,501 kg	1,440 m ² 25,200 kg	756,000 kg		Alb UGL	R10/A	W171 (m ²)
8471-B660HK	40 x 120	397 x 1197 x 8	2,083 St pc	3 St pc	51,848 m ²		Alb UGL	R10/A	W171 (m ²)
8472-B660HK			17,497 kg	1,440 m ² 25,200 kg	907,200 kg		Alb UGL	R10/A	W171 (m ²)

Bodenfliese | carreau de sol | floor tile

Feinsteinzeugplatten unglasiert | grès fin non-émaillés | porcelain stoneware tiles unglazed

30 x 120 cm



8471-B620HK

Eiche natur | chêne nature | natural oak
strukturiert, matt | structuré, mat | structured, matt

8472-B620HK

Eiche anthrazit | chêne anthracite | anthracite oak
strukturiert, matt | structuré, mat | structured, matt

40 x 120 cm



8471-B660HK

Eiche natur | chêne nature | natural oak
strukturiert, matt | structuré, mat | structured, matt

8472-B660HK

Eiche anthrazit | chêne anthracite | anthracite oak
strukturiert, matt | structuré, mat | structured, matt

610 OAK

Art.	Nennmaß cote nominale nominal size cm	Herstellmaß cote de fabrication production size mm	m ² /m	Paket carton box	Palette palette pallet	Beanspr.-Gruppe groupe d'emploi wear resist. group	Norm Norme Standard	Trittsicherheit antidérapance non-slip	Preisgruppe groupe de prix price category
8471-B670HK	60 x 120	597 x 1197 x 8	1,388 St pc / m ²	2 St pc	36,023 m ²		Alb UGL	R10/A	W171 (m ²)
8472-B670HK			17,489 kg	1,441 m ² 25,200 kg	630,000 kg		Alb UGL	R10/A	W171 (m ²)
8471-B629HK	30 x 120	297 x 1197 x 8	0,833 St pc / m	4 St pc			Alb UGL	R10/A	W559 (St pc)
8472-B629HK			5,248 kg	4,802 m 25,200 kg			Alb UGL	R10/A	W559 (St pc)



Eiche natur
chêne nature
natural oak

V4



Eiche anthrazit
chêne anthracite
anthracite oak

V3

Bodenfliese | carreau de sol | floor tile

Feinsteinzeugplatten unglasiert | grès fin non-émaillés | porcelain stoneware tiles unglazed

60 x 120 cm



8471-B670HK

Eiche natur | chêne nature | natural oak
strukturiert, matt | structuré, mat | structured, matt

8472-B670HK

Eiche anthrazit | chêne anthracite | anthracite oak
strukturiert, matt | structuré, mat | structured, matt

Treppenfliese | nez de marche | stair tile

Feinsteinzeugplatten unglasiert | grès fin non-émaillés | porcelain stoneware tiles unglazed

30 x 120 cm



8471-B629HK

Eiche natur | chêne nature | natural oak
strukturiert, matt | structuré, mat | structured, matt

8472-B629HK

Eiche anthrazit | chêne anthracite | anthracite oak
strukturiert, matt | structuré, mat | structured, matt

Auftragsfertigung: Rückgabe und/oder Stornierung bestellter Ware nicht möglich.

Fabrication sur commande : il nous est impossible d'accepter l'annulation de commandes d'articles ou le retour d'articles.

Make-to-order production: return and/or cancellation of ordered products not possible.

Art.	Nennmaß cote nominale nominal size cm	Herstellmaß cote de fabrication production size mm	m	Paket carton box	Palette palette pallet	Beanspr.-Gruppe groupe d'emploi wear resist. group	Norm Norme Standard	Trittsicherheit antidérapance non-slip	Preisgruppe groupe de prix price category
8471-B610HK	6 x 60	60 x 597 x 8	1,667 St pc	27 St pc			Alb UGL		W439 (St pc)
8472-B610HK			1,100 kg	16,197 m	17,820 kg		Alb UGL		W439 (St pc)
8471-B698HK	30 x 35	298 x 344,1 x 8	3,333 St pc	3 St pc			Alb UGL	R10/A	W518 (St pc)
8472-B698HK			4,166 kg	0,900 m	3,750 kg		Alb UGL	R10/A	W518 (St pc)

Sockel, gerundet | plinthe, arrondie | skirting, rounded

Feinsteinzeugplatten unglasiert | grès fin non-émaillés | porcelain stoneware tiles unglazed

6 x 60 cm

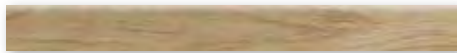

8471-B610HK

V4

Eiche natur | chêne nature | natural oak
strukturiert, matt | structuré, mat | structured, matt

8472-B610HK

V3

Eiche anthrazit | chêne anthracite | anthracite oak
strukturiert, matt | structuré, mat | structured, matt

Dekorationselemente | éléments décoratifs | decoration elements

Dekorfliese Hexagon | carreau décoratif Hexagon | decorative element Hexagon

Feinsteinzeugplatten unglasiert | grès fin non-émaillés | porcelain stoneware tiles unglazed

30 x 35 cm



V4

8471-B698HK

Eiche natur | chêne nature | natural oak
strukturiert, matt | structuré, mat | structured, matt



V3

8472-B698HK

Eiche anthrazit | chêne anthracite | anthracite oak
strukturiert, matt | structuré, mat | structured, matt

Mosaik, Verklebung rückseitig auf Glasfasernetz,
Bogen: 298 x 344,1 mm

Mosaïque, collée sur trame en fibre de verre à
l'envers, Feuille: 298 x 344,1 mm

Mosaic, glass fibre net on reverse side,
Sheet: 298 x 344.1 mm

Abgabe der Dekorationselemente ausschließlich in vollen Kartons.
Éléments décoratifs uniquement livrables en cartons entiers.
Decoration elements only available in full boxes.





Ein Zitat aus der Natur

Für Liebhaber von natürlicher Optik: Die markant strukturierte Oberfläche der Serie Pizarro erinnert an Schiefergestein – keramisch umgesetzt. Die Wandfliesen in schlichtem Weiß und zartem Grau sind eine perfekte Wandbekleidung für zeitlose Badezimmer in einem reduzierten Ambiente. Für eine Rhythmisierung oder Akzentuierung der Wandfläche stehen elegante Bordüren mit metallischen Einlegern zur Verfügung.

Une citation de la nature

Pour les amateurs d'un visuel naturel: la surface remarquablement structurée de la série Pizarro rappelle celle de l'ardoise – version céramique. Les carreaux de mur en blanc uni et gris délicat sont un revêtement mural parfait pour les salles de bains hors temps dans une ambiance minimaliste. Des bordures élégantes avec des incrustations métalliques sont disponibles pour rythmer ou accentuer la surface du mur.

A quotation from nature

For lovers of a natural look: the strikingly structured surface of the Pizarro series is reminiscent of slate – in a ceramic interpretation. The wall tiles in plain white and delicate grey are a perfect wall cladding for timeless bathrooms in a reduced ambience. For a rhythmic or accentuated look of the wall surface, elegant borders with metallic inlays are available.

Art.	Nennmaß cote nominale nominal size cm	Herstellmaß cote de fabrication production size mm	m ² /m	Paket carton box	Palette palette pallet	Beanspr.-Gruppe groupe d'emploi wear resist. group	Norm Norme Standard	Trittsicherheit antidérapance non-slip	Preisgruppe groupe de prix price category
281476	30 x 60	297 x 597 x 9	5,556 St pc / m ²	9 St pc	77,754 m ²		BIII GL		C107 (m ²)
281477			14,946 kg	1,620 m ² 24,210 kg	1.162,080 kg		BIII GL		C107 (m ²)
281479	15 x 60	147 x 597 x 10,5	1,667 St pc / m	1 St pc			Bla UGL		C510 (St pc)
281480			3,584 kg	0,600 m 2,150 kg			Bla UGL		C510 (St pc)

Wandfliese | carreau de mur | wall tile
Steingut glasiert | faïence émaillée | earthenware glazed

30 x 60 cm

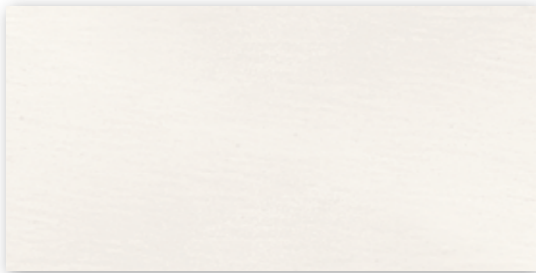

V1



V1

281476
weiß | blanc | white
strukturiert, seidenmatt | structuré, satiné | structured, silky-matt

281477
grau | gris | grey
strukturiert, seidenmatt | structuré, satiné | structured, silky-matt

Dekorationselemente | éléments décoratifs | decoration elements

Bordüre | bordure | border
Feinsteinzeugfliesen unglasiert | grès cérame fin vitrifié non-émaillés | porcelain stoneware tiles unglazed

15 x 60 cm



281479
anthrazit | anthracite
strukturiert, matt | structuré, mat | structured, matt

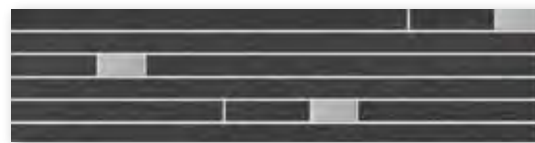

281480
schwarz | noir | black
strukturiert, matt | structuré, mat | structured, matt

Nur für die Verlegung an der Wand geeignet.
Uniquement approprié pour l'utilisation aux murs.
Only suitable for laying on the wall.

Abgabe der Dekorationselemente ausschließlich in vollen Kartons.
Éléments décoratifs uniquement livrables en cartons entiers.
Decoration elements only available in full boxes.

Bordüre, Verklebung rückseitig auf Glasfasernetz,
Bogen: 147 x 597 mm
Bordure, collée sur trame en fibre de verre à
l'envers, Feuille : 147 x 597 mm
Border, glass fibre net on reverse side,
Sheet: 147 x 597 mm



Mix aus Beton, Ornamenten und Farben

Schon das Basis Design der Sento überzeugt mit seiner modernen Betonoptik. Und es lässt sich wunderbar mit den feinen floralen Ornamenten des Blossom Dekors verbinden. Wer mehr Kontrast wünscht, verbindet die Betonoptik einfach mit dem leuchtend, farbigen Stäbchenmosaik dieser Serie. Alle Fliesen dieser Serie – mit Ausnahme des Stripe Dekors – sind Hytect-veredelt.

Mélange de béton, d'ornements et de couleurs

Le design de base de Sento convainc déjà par son aspect moderne en béton. Il se marie à merveille avec les délicats ornements floraux du décor Blossom. Pour ceux qui souhaitent plus de contraste, il suffit d'associer l'aspect béton à la mosaïque en bâtonnets de couleurs vives de cette série. Tous les carreaux de cette série – à l'exception du décor Stripe – ont une finition Hytect.

Mix of concrete, ornaments and colors

Even the basic design of Sento is convincing with its modern concrete look. And it can be wonderfully combined with the fine floral ornaments of the Blossom decor. Those who want more contrast, simply combine the concrete look with the brightly colored rod mosaic of this series. All tiles of this series – with the exception of the Stripe decor – are Hytect-coated.





Art.	Nennmaß cote nominale nominal size cm	Herstellmaß cote de fabrication production size mm	m ²	Paket carton box	Palette palette pallet	Beanspr.-Gruppe groupe d'emploi wear resist. group	Norm Norme Standard	Trittsicherheit antidérapance non-slip	Preisgruppe groupe de prix price category
203412H	30 x 60	297 x 597 x 6	5,556 St pc 10,279 kg	13 St pc 2,340 m ² 24,050 kg	112,311 m ² 1.154, 400 kg		BIII GL	W90 (m ²)	
363414H	35 x 100	347 x 997 x 6	2,857 St pc 10,108 kg	5 St pc 1,750 m ² 17,690 kg	70,000 m ² 707,600 kg		BIII GL	W156 (m ²)	

Wandfliese | carreau de mur | wall tile
Steingut glasiert | faïence émaillée | earthenware glazed

30 x 60 cm

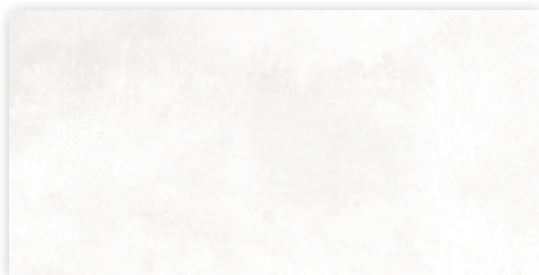

203412H
pale white
strukturiert, steinmatt
structuré, pierre mat
structured, stone-matt

35 x 100 cm

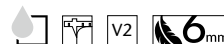
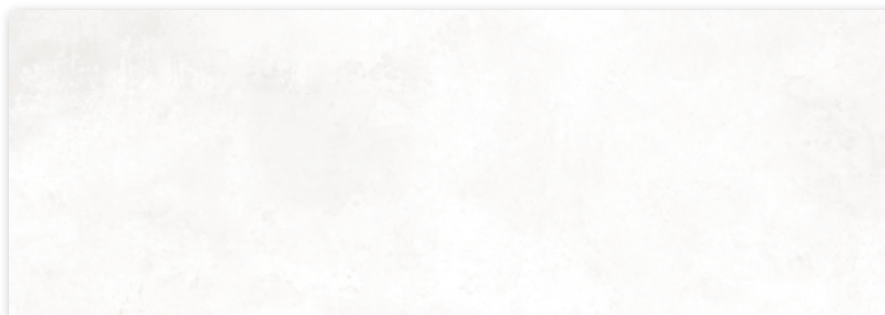

363414H
pale white
strukturiert, steinmatt
structuré, pierre mat
structured, stone-matt

Art.	Nennmaß cote nominale nominal size cm	Herstellmaß cote de fabrication production size mm	m ²	Paket carton box	Palette palette pallet	Beanspr.-Gruppe groupe d'emploi wear resist. group	Norm Norme Standard	Trittsicherheit antidérapance non-slip	Preisgruppe groupe de prix price category
203413H	30 x 60	297 x 597 x 6	5,556 St pc 10,279 kg	13 St pc 2,340 m ² 24,050 kg	112,311 m ² 1.154, 400 kg		BIII GL	W102 (m²)	
363415H	35 x 100	347 x 997 x 6	2,857 St pc 10,108 kg	5 St pc 1,750 m ² 17,690 kg	70,000 m ² 707,600 kg		BIII GL	W162 (m²)	

Dekorationselemente | éléments décoratifs | decoration elements

Dekorfliese Blossom | carreau décoratif Blossom | decorative element Blossom

Steingut glasiert | faïence émaillée | earthenware glazed

30 x 60 cm



203413H
beige grey
strukturiert, steinmatt
structuré, pierre mat
structured, stone-matt

35 x 100 cm

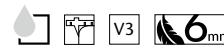

363415H
beige grey
strukturiert, steinmatt
structuré, pierre mat
structured, stone-matt

Art.	Nennmaß cote nominale nominal size cm	Herstellmaß cote de fabrication production size mm	m	Paket carton box	Palette palette pallet	Beanspr.-Gruppe groupe d'emploi wear resist. group	Norm Norme Standard	Trittsicherheit antidérapance non-slip	Preisgruppe groupe de prix price category
203408							Bla GL		W559 (St.)
203409	30 x 30	297 x 297 x 6,5	3,333 Bögen plaques sheets	5 Bögen plaques sheets			Bla GL		W559 (St.)
203410			3,326 kg	1,500 m	4,990 kg		Bla GL		W559 (St.)
203411							Bla GL		W559 (St.)

Dekorationselemente | éléments décoratifs | decoration elements

Schnittdekor Color Stripe | Décor découpé Color Stripe | Cut decoration Color Stripe

Feinsteinzeugfliesen glasiert | grès cérame fin vitrifié émaillés | porcelain stoneware tiles glazed

30 x 30 cm

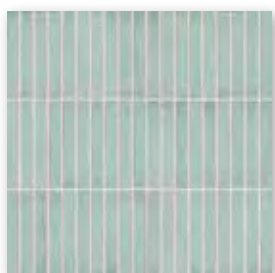

203408



sky aqua
strukturiert, semi-matt
structuré, semi-mat
structured, semi-matt

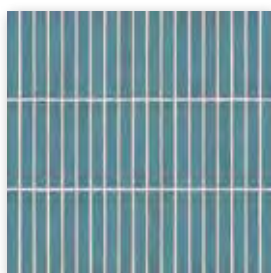

203409



pacific blue
strukturiert, semi-matt
structuré, semi-mat
structured, semi-matt

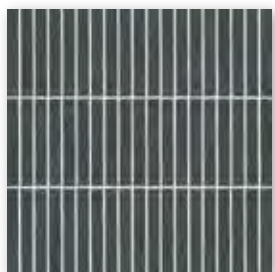

203410



lava black
strukturiert, semi-matt
structuré, semi-mat
structured, semi-matt



203411



earth red
strukturiert, semi-matt
structuré, semi-mat
structured, semi-matt

Nur für die Verlegung an der Wand geeignet.
Uniquement approprié pour l'utilisation aux murs.
Only suitable for laying on the wall.

Abgabe der Dekorationselemente ausschließlich in vollen Kartons.
Éléments décoratifs uniquement livrables en cartons entiers.
Decoration elements only available in full boxes.

Art.	Nennmaß cote nominale nominal size cm	Herstellmaß cote de fabrication production size mm	m ²	Paket carton box	Palette palette pallet	Beanspr.-Gruppe groupe d'emploi wear resist. group	Norm Norme Standard	Trittsicherheit antidérapance non-slip	Preisgruppe groupe de prix price category
431605H	30 x 60	297 x 597 x 6	5,556 St pc 13,273 kg	10 St pc 1,800 m ² 23,890 kg	71,994 m ² 955,600 kg		Bla UGL	R10/A+B	W90 (m ²)
431606H									W90 (m ²)
431607H									W90 (m ²)
431608H									W90 (m ²)
431609H	60 x 60	597 x 597 x 6	2,778 St pc 13,581 kg	5 St pc 1,800 m ² 24,445 kg	64,795 m ² 880,020 kg		Bla UGL	R10/A+B	W111 (m ²)
431610H									W111 (m ²)
431611H									W111 (m ²)
431612H									W111 (m ²)



off white



concrete grey



pale mud

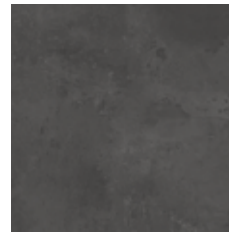

dark anthracite



Bodenfliese | carreau de sol | floor tile

Feinsteinzeugfliesen unglasiert | grès cérame fin vitrifié non-émaillés | porcelain stoneware tiles unglazed

30 x 60 cm



431605H

off white
strukturiert, matt
structuré, mat
structured, matt



431606H

concrete grey
strukturiert, matt
structuré, mat
structured, matt

431607H

pale mud
strukturiert, matt
structuré, mat
structured, matt

431608H

dark anthracite
strukturiert, matt
structuré, mat
structured, matt

60 x 60 cm



431609H

off white
strukturiert, matt
structuré, mat
structured, matt



431610H

concrete grey
strukturiert, matt
structuré, mat
structured, matt

431611H

pale mud
strukturiert, matt
structuré, mat
structured, matt

431612H

dark anthracite
strukturiert, matt
structuré, mat
structured, matt

Geeignet für den Einsatz in Bereichen mit Belastungsgruppe 1.
Se prête à l'utilisation dans les zones de la classe de sollicitation 1.
Suitable for the use in areas with stress group 1.

Art.	Nennmaß cote nominale nominal size cm	Herstellmaß cote de fabrication production size mm	m ²	Paket carton box	Palette palette pallet	Beanspr.-Gruppe groupe d'emploi wear resist. group	Norm Norme Standard	Trittsicherheit antidérapance non-slip	Preisgruppe groupe de prix price category
431613H							Bla UGL	R10/A+B	W138 (m ²)
431614H	60 x 120	597 x 1197 x 6	1,388 St pc	3 St pc	64,841m ²		Bla UGL	R10/A+B	W138 (m ²)
431615H			14,088 kg	2,161 m ² 30,450 kg	913,500 kg		Bla UGL	R10/A+B	W138 (m ²)
431616H							Bla UGL	R10/A+B	W138 (m ²)



off white



concrete grey



pale mud



dark anthracite



Bodenfliese | carreau de sol | floor tile

Feinsteinzeugfliesen unglasiert | grès cérame fin vitrifié non-émaillés | porcelain stoneware tiles unglazed

60 x 120 cm



431613H

off white
strukturiert, matt
structuré, mat
structured, matt

431615H

pale mud
strukturiert, matt
structuré, mat
structured, matt



431614H

concrete grey
strukturiert, matt
structuré, mat
structured, matt

431616H

dark anthracite
strukturiert, matt
structuré, mat
structured, matt

Art.	Nennmaß cote nominale nominal size cm	Herstellmaß cote de fabrication production size mm	m ² /m	Paket carton box	Palette palette pallet	Beanspr.-Gruppe groupe d'emploi wear resist. group	Norm Norme Standard	Trittsicherheit antidérapance non-slip	Preisgruppe groupe de prix price category
431617H							Bla UGL	R10/A+B	W117 (m ²)
431618H	60 x 60	597 x 597 x 6	2,778 St pc/m ²	5 St pc	64,795 m ²		Bla UGL	R10/A+B	W117 (m ²)
431619H			13,581 kg/m ²	1,800 m ² 24,445 kg	880,020 kg		Bla UGL	R10/A+B	W117 (m ²)
431620H							Bla UGL	R10/A+B	W117 (m ²)
431621H							Bla UGL		W439 (St.)
431622H	7 x 60	70 x 597 x 6	1,667 St pc/m	38 St pc			Bla UGL		W439 (St.)
431623H			0,938 kg/m	22,795 m 21,394 kg			Bla UGL		W439 (St.)
431624H							Bla UGL		W439 (St.)

Dekorationselemente | éléments décoratifs | decoration elements

Bodendekor Blossom | Décor de sol Blossom | Floor decor Blossom

Feinsteinzeugfliesen unglasiert | grès cérame fin vitrifié non-émaillés | porcelain stoneware tiles unglazed

60 x 60 cm



431617H
off white
strukturiert, matt
structuré, mat
structured, matt

431618H
concrete grey
strukturiert, matt
structuré, mat
structured, matt

431619H
pale mud
strukturiert, matt
structuré, mat
structured, matt

431620H
dark anthracite
strukturiert, matt
structuré, mat
structured, matt

Sockel, geschnitten | plinthe, à bord vif | skirting, cut

Feinsteinzeugfliesen unglasiert | grès cérame fin vitrifié non-émaillés | porcelain stoneware tiles unglazed

7 x 60 cm



431621H
off white
strukturiert, matt
structuré, mat
structured, matt

431622H
concrete grey
strukturiert, matt
structuré, mat
structured, matt

431623H
pale mud
strukturiert, matt
structuré, mat
structured, matt

431624H
dark anthracite
strukturiert, matt
structuré, mat
structured, matt

Abgabe der Dekorationselemente ausschließlich in vollen Kartons.
Éléments décoratifs uniquement livrables en cartons entiers.
Decoration elements only available in full boxes.

Geeignet für den Einsatz in Bereichen mit Belastungsgruppe 1.
Se prête à l'utilisation dans les zones de la classe de sollicitation 1.
Suitable for the use in areas with stress group 1.

Art.	Nennmaß cote nominale nominal size cm	Herstellmaß cote de fabrication production size mm	m/m ²	Paket carton box	Palette palette pallet	Beanspr.-Gruppe groupe d'emploi wear resist. group	Norm Norme Standard	Trittsicherheit antidérapance non-slip	Preisgruppe groupe de prix price category
431601H							Bla UGL	R10/A+B	W309 (m ²)
431602H	5 x 5	47 x 47 x 6	11,111 Bögen plaques sheets	11 Bögen plaques sheets	35,640 m ²		Bla UGL	R10/A+B	W309 (m ²)
431603H			11,488 kg/m ²	0,990 m ² 11,374 kg	409,464 kg		Bla UGL	R10/A+B	W309 (m ²)
431604H							Bla UGL	R10/A+B	W309 (m ²)

Mosaik | mosaïque | mosaic

Feinsteinzeugfliesen unglasiert | grès cérame fin vitrifié non-émaillés | porcelain stoneware tiles unglazed

5 x 5 cm



431601H
off white
strukturiert, matt
structuré, mat
structured, matt



431602H
concrete grey
strukturiert, matt
structuré, mat
structured, matt



431603H
pale mud
strukturiert, matt
structuré, mat
structured, matt

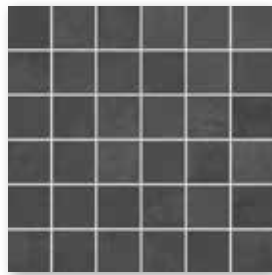

431604H
dark anthracite
strukturiert, matt
structuré, mat
structured, matt

Mosaik, Verklebung rückseitig auf Glasfasernetz
Bogen: 297 x 297 mm

Mosaïque, collée sur trame en fibre de verre à
l'envers, Feuille: 297 x 297 mm

Mosaic, glass fibre net on reverse side
Sheet: 297 x 297 mm

Geeignet für den Einsatz in Bereichen mit Belastungsgruppe 1.
Se prête à l'utilisation dans les zones de la classe de sollicitation 1.
Suitable for the use in areas with stress group 1.



Ursprünglich und edel

Die Feinsteinzeug-Serie Sierra bringt durch ihre Farben und Oberflächenoptik Ursprünglichkeit und Natürlichkeit in den Wohnraum. Die Farbstellung Hellbeige gibt die Charakteristika von Sandstein authentisch wieder: dezente Farbschichtungen mit typischen Farbverläufen. In der Variante Anthrazit erfahren die Stäbchenmosaiken in unterschiedlichen Formaten und Schnittrichtungen eine stärkere Betonung des Mauerwerkscharakters. Passende Bodenfliesen in den Formaten 5 x 5 cm und 30 x 60 cm sind in den vier Serienfarben (neben Hellbeige und Anthrazit, Hellgrau und Weiß) verfügbar. Die Boden- und Treppenfliesen (30 x 60 cm) sind Protecta-verbessert und trittsicher R9.

Authentique et noble

De par ses teintes et sa structure de surface, la série de grès cérame Sierra apporte à vos intérieurs une touche d'authenticité et de naturel. La couleur beige clair restitue fidèlement les caractéristiques du grès : strates de couleur beige clair et nuances reconnaissables. Les bâtonnets de mosaïque aux formats et sens de coupe différents soulignent l'aspect maçonné. Les carreaux de sol assortis sont disponibles en formats différents 5 x 5 cm et 30 x 60 cm et dans quatre palettes de couleurs (beige clair et anthracite mais aussi gris clair et blanc). Les carreaux de sol et d'escalier (30 x 60 cm) ont reçu une finition Protecta et sont antidérapants R9.

Original and elegant

The porcelain stoneware Sierra series adds originality and naturalness to living areas thanks to its colors and surface look. The color light-beige authentically reflects the characteristics of sandstone and its subtle color layers with typical color variations. In the anthracite variant, block mosaics in various sizes and cutting angles emphasize the masonry character even further. Matching floor tiles in the sizes 5 x 5 cm and 30 x 60 cm are available in the four colors of the series (light-beige, anthracite, light-grey and white). The floor and stair tiles (30 x 60 cm) are Protecta-upgraded and feature non-slip R9.

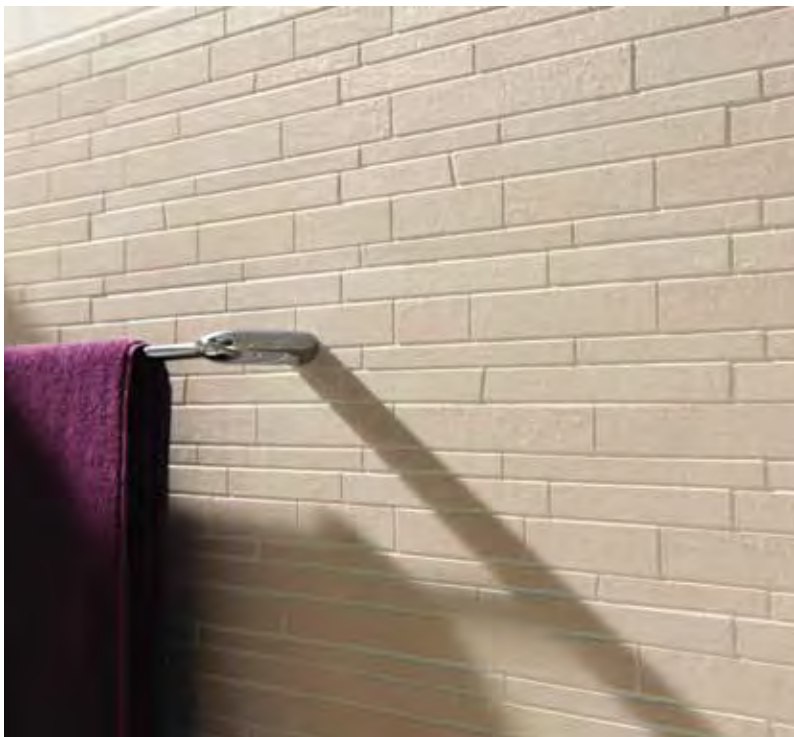



Art.	Nennmaß cote nominale nominal size cm	Herstellmaß cote de fabrication production size mm	m ²	Paket carton box	Palette palette pallet	Beanspr.-Gruppe groupe d'emploi wear resist. group	Norm Norme Standard	Trittsicherheit antidérapance non-slip	Preisgruppe groupe de prix price category
431383							Bla UGL	R10	C107 (m ²)
431384	30 x 60	297 x 597 x 9	5,556 St pc	7 St pc	50,396 m ²		Bla UGL	R10	C107 (m ²)
431385			19,907 kg	1,260 m ² 25,081 kg	1.003,240 kg		Bla UGL	R10	C107 (m ²)



anthrazit
anthracite



hellgrau
gris clair
light-grey

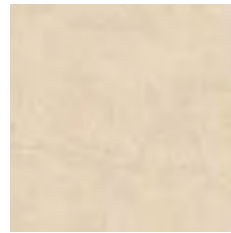

hellbeige
beige clair
light-beige



Bodenfliese | carreau de sol | floor tile

Feinsteinzeugfliesen unglasiert | grès cérame fin vitrifié non-émaillés | porcelain stoneware tiles unglazed

30 x 60 cm



431383

anthrazit | anthracite
strukturiert, matt
structuré, mat
structured, matt

431384

hellgrau | gris clair | light-grey
strukturiert, matt
structuré, mat
structured, matt

431385

hellbeige | beige clair | light-beige
strukturiert, matt
structuré, mat
structured, matt

Art.	Nennmaß cote nominale nominal size cm	Herstellmaß cote de fabrication production size mm	m	Paket carton box	Palette palette pallet	Beanspr.-Gruppe groupe d'emploi wear resist. group	Norm Norme Standard	Trittsicherheit antidérapance non-slip	Preisgruppe groupe de prix price category
431389							Bla UGL	R10	C474 (St pc)
431390	30 x 60	297 x 597 x 9	1,667 St pc	7 St pc			Bla UGL	R10	C474 (St pc)
431391			5,973 kg	4,199 m	25,081 kg		Bla UGL	R10	C474 (St pc)
431392							Bla UGL		C440 (St pc)
431393	7 x 60	70 x 597 x 9	1,667 St pc	22 St pc			Bla UGL		C440 (St pc)
431394			1,357 kg	13,197 m	17,908 kg		Bla UGL		C440 (St pc)

Treppenfliese | nez de marche | stair tile

Feinsteinzeugfliesen unglasiert | grès cérame fin vitrifié non-émaillés | porcelain stoneware tiles unglazed

30 x 60 cm



Auftragsfertigung: Rückgabe und/oder Stornierung bestellter Ware nicht möglich.

Fabrication sur commande : il nous est impossible d'accepter l'annulation de commandes d'articles ou le retour d'articles.

Make-to-order production: return and/or cancellation of ordered products not possible.

431389

anthrazit | anthracite
strukturiert, matt | structuré, mat | structured, matt

431390

hellgrau | gris clair | light-grey
strukturiert, matt | structuré, mat | structured, matt

431391

hellbeige | beige clair | light-beige
strukturiert, matt | structuré, mat | structured, matt

Sockel, gerundet | plinthe, arrondie | skirting, rounded

Feinsteinzeugfliesen unglasiert | grès cérame fin vitrifié non-émaillés | porcelain stoneware tiles unglazed

7 x 60 cm



431392

anthrazit | anthracite
strukturiert, matt | structuré, mat | structured, matt

431393

hellgrau | gris clair | light-grey
strukturiert, matt | structuré, mat | structured, matt

431394

hellbeige | beige clair | light-beige
strukturiert, matt | structuré, mat | structured, matt

Art.	Nennmaß cote nominale nominal size cm	Herstellmaß cote de fabrication production size mm	m ²	Paket carton box	Palette palette pallet	Beanspr.-Gruppe groupe d'emploi wear resist. group	Norm Norme Standard	Trittsicherheit antidérapance non-slip	Preisgruppe groupe de prix price category
431380							Bla UGL	R10/B	C341 (m ²)
431381	5 x 5	47 x 47 x 9	11,111 Bögen plaques sheets	12 Bögen plaques sheets	32,400 m ²		Bla UGL	R10/B	C341 (m ²)
431382			19,833 kg	1,080 m ² 21,420 kg	642,600 kg		Bla UGL	R10/B	C341 (m ²)
431386							Bla UGL	R10	C383 (m ²)
431387	30 x 30	298 x 298 x 9	11,111 Bögen plaques sheets	12 Bögen plaques sheets	32,400 m ²		Bla UGL	R10	C383 (m ²)
431388			20,755 kg	1,080 m ² 22,416 kg	672,480 kg		Bla UGL	R10	C383 (m ²)

Mosaik | mosaïque | mosaic

Feinsteinzeugfliesen unglasiert | grès cérame fin vitrifié non-émaillés | porcelain stoneware tiles unglazed

5 x 5 cm

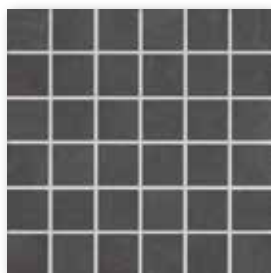

431380
anthrazit | anthracite
strukturiert, matt
structuré, mat
structured, matt



431381
hellgrau | gris clair | light-grey
strukturiert, matt
structuré, mat
structured, matt



431382
hellbeige | beige clair | light-beige
strukturiert, matt
structuré, mat
structured, matt



Mosaik, Verklebung
rückseitig auf
Glasfasernetz, Bogen:
297 x 297 mm

Mosaïque, collée sur
trame en fibre de verre
à l'envers, Feuille :
297 x 297 mm

Mosaic, glass fibre net
on reverse side, Sheet:
297 x 297 mm

Riegelmosaik | Mosaïques en traverse | oblong mosaic

Feinsteinzeugfliesen unglasiert | grès cérame fin vitrifié non-émaillés | porcelain stoneware tiles unglazed

30 x 30 cm



431386
anthrazit | anthracite
strukturiert, matt
structuré, mat
structured, matt

V2



431387
hellgrau | gris clair | light-grey
strukturiert, matt
structuré, mat
structured, matt

V2



431388
hellbeige | beige clair | light-beige
strukturiert, matt
structuré, mat
structured, matt

V2



Verklebung rückseitig auf Glasfasernetz,
Bogen: 298 x 298 mm

Collage sur trame en fibre de verre à l'envers,
Feuille : 298 x 298 mm

Glass fibre net on reverse side,
Sheet: 298 x 298 mm

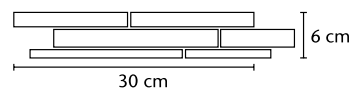

Vorschlag für Bordüregestaltung:
Aus einem Mosaikbogen können fünf
Bordüren gemäß beigefügter Skizze
entnommen werden = 1,5 lfm.

Proposition pour l'aménagement de
bordures : Une feuille en mosaïques
peut être divisée en cinq bordures
selon le croquis ci-joint = 1,5 ml.

Proposal for borders design: five
borders can be taken from one mosaic
sheet according to the enclosed sketch
= 1.5 lin. m.







Luzid, heiter – und ein Hauch Dynamik

Mit Sky verwandeln sich Bäder in lichthelle Räume. Für mehr Tiefenwirkung sorgt die Oberflächenvariante „glänzend“ – alternativ erlaubt „matt“ eine naturnahe Gestaltung. Mit der reinigungsfreundlichen Hytect-Oberfläche der Wandfliesen, zwei Farben – Grau oder Beige – sowie einem Format mit 30 x 90 cm gibt Sky ein klares und selbstbewusstes Statement ab. Als passende Bodenserie empfiehlt sich Oak, aus der auch das skandinavisch-dynamische Dekor Verso in 10 x 90 cm geschnitten wurde. Dekor und Boden sind in Eiche natur oder Eiche anthrazit erhältlich.

Lucidité, entrain et un soupçon de dynamisme

Sky transforme la salle de bains en une pièce lumineuse. La touche de profondeur est apportée par la finition de surface « brillante » ou la finition « mat » pour un rendu naturel. Avec la surface Hytect facile à nettoyer des carreaux de mur, deux couleurs – gris ou beige – et un format de 30 x 90 cm, Sky fait une déclaration claire et avec une grande assurance. Le choix de Oak comme gamme de sol complémentaire paraît comme une évidence, tout comme celui de l'élément de décor dynamique Verso de 10 x 90 cm, d'inspiration scandinave, issu de la même gamme. L'élément de décoration et les carreaux de sol sont disponibles dans les teintes chêne naturel et chêne anthracite.

Lucid, cheerful – and a touch of dynamism

Sky transforms bathrooms into ultra-bright spaces. More depth is effected by the “glossy” surface variant, while “matt” permits a more natural design. With the easy-clean Hytect surface of the wall tiles, two colors – grey or beige – and a format of 30 x 90 cm, Sky makes a clear and self-confident statement. Oak is ideal as a matching floor series – from which the dynamic Scandinavian-style Verso decor in 10 x 90 cm is also cut. Both the decor and the floor tiles are available in natural oak or anthracite oak.

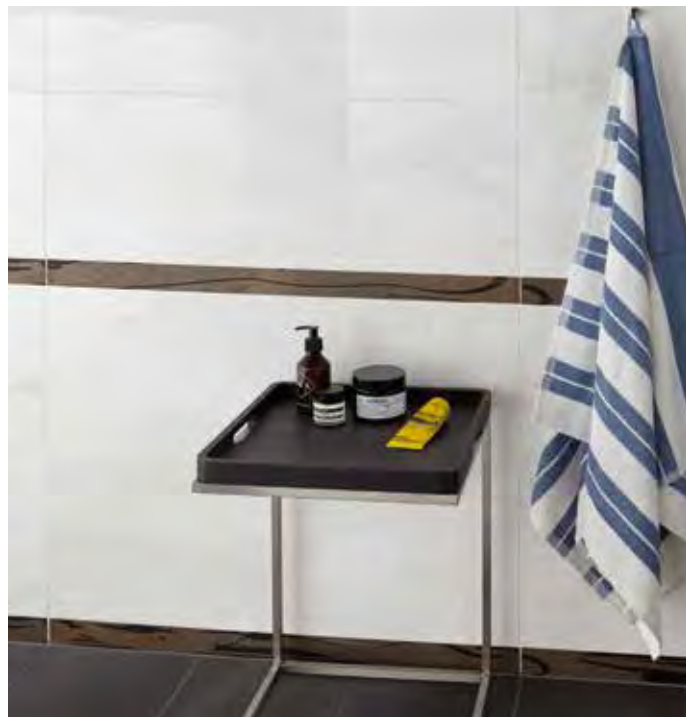

Art.	Nennmaß cote nominale nominal size cm	Herstellmaß cote de fabrication production size mm	m ²	Paket carton box	Palette palette pallet	Beanspr.-Gruppe groupe d'emploi wear resist. group	Norm Norme Standard	Trittsicherheit antidérapance non-slip	Preisgruppe groupe de prix price category
392911H							BIII GL	W162 (m²)	
392912H	30 x 90	297 x 897 x 10,5	3,704 St pc	5 St pc	32,397 m ²		BIII GL	W162 (m²)	
392913H			17,976 kg	1,350 m ² 24,265 kg	582,360 kg		BIII GL	W162 (m²)	
392914H							BIII GL	W162 (m²)	

Wandfliese | carreau de mur | wall tile

Steingut glasiert | faïence émaillée | earthenware glazed

30 x 90 cm

**392911H**

grau | gris | grey
eben, glänzend | lisse, brillant | smooth, glossy

**392912H**

grau | gris | grey
eben, seidenmatt | lisse, satinée | smooth, silky matt

**392913H**

beige
eben, glänzend | lisse, brillant | smooth, glossy

**392914H**

beige
eben, seidenmatt | lisse, satinée | smooth, silky matt

Art.	Nennmaß cote nominale nominal size cm	Herstellmaß cote de fabrication production size mm	m	Paket carton box	Palette palette pallet	Beanspr.-Gruppe groupe d'emploi wear resist. group	Norm Norme Standard	Trittsicherheit antidérapance non-slip	Preisgruppe groupe de prix price category	
392918	5 x 90	47 x 897 x 10,5	1,111 St pc	3 St pc					Bla UGL	W446 (St pc)
392919			1,161 kg	2,700 m					3,135 kg	Bla UGL
392915H	10 x 90	97 x 897 x 8							Alb UGL	W534 (St pc)
392916H			1,111 St pc	2 St pc					Alb UGL	W534 (St pc)
392917H			1,667 kg	1,800 m					3,000 kg	Alb UGL

Dekorationselemente | éléments décoratifs | decoration elements

Bordüre Paint | bordure Paint | border Paint

Feinsteinzeugfliesen unglasiert | grès cérame fin vitrifié non-émaillés | porcelain stoneware tiles unglazed

5 x 90 cm



392918

grau | gris | grey

strukturiert, matt | structuré, mat | structured, matt

Nur für die Verlegung an der Wand im Innenbereich geeignet.

Convient uniquement pour une pose murale en intérieur.

Only suitable for laying on the wall in indoor areas.



392919

beige

strukturiert, matt | structuré, mat | structured, matt

Bordüre Verso | bordure Verso | border Verso

Feinsteinzeugfliesen unglasiert | grès cérame fin vitrifié non-émaillés | porcelain stoneware tiles unglazed

10 x 90 cm



392916H

Eiche natur | chêne nature | natural oak

strukturiert, matt | structuré, mat | structured, matt

Nur für die Verlegung an der Wand geeignet. Materialbedingt gibt es einen kleinen Höhenunterschied zwischen Dekoration und Flächenware. Bitte diesen Unterschied bei der Verlegung durch einen höheren Kleberauftrag im Bereich der Dekoration ausgleichen.

Pose murale uniquement. La différence d'épaisseur entre les matériaux entraîne une légère différence de niveau entre l'élément de décoration et le reste des carreaux. Cette différence sera comblée facilement par l'application d'une quantité plus importante de colle au niveau du décor.



392915H

Eiche creme | chêne crème | cream oak

strukturiert, matt | structuré, mat | structured, matt

Only suitable for laying on the wall. Due to the material properties, there is a slight difference in height between the décor and the remaining tiles. Please compensate for this height difference by applying more adhesive to the décor tile.

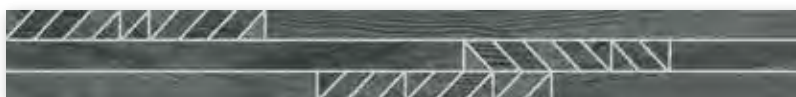

392917H

Eiche anthrazit | chêne anthracite | anthracite oak

strukturiert, matt | structuré, mat | structured, matt

Abgabe der Dekorationselemente ausschließlich in vollen Kartons.
Éléments décoratifs uniquement livrables en cartons entiers.
Decoration elements only available in full boxes.

Natürlich ausdrucksstark

Solid Rock – schon dieser Name ist ein klares Statement. Und die robuste Qualität dieser Serie ist fast in Stein gemeißelt. Solid Rock hebt die Grenzen zwischen Innen und Außen auf. Rein ästhetisch, weil sie die Kraft der Natur in Bäder, Foyers und alle anderen Räume bringt. Grenzenlose Möglichkeiten bieten sich aber auch bei der Verlegung. Weil Innenfliesen im Verbund mit Solid Rock Terrassenplatten nahtlose Übergänge zwischen Drinnen und Draußen realisieren. Ein Highlight für Hotels und Restaurants, aber auch im privaten Wohnbereich. Die lebendige Struktur der Fliesen akzentuiert Räume klar und stringent. Der Mauerverbund Move erweitert die gestalterischen Freiheiten für Architekten und Planer noch einmal. Das liegt an den verschiedenen und sorgfältig ausgewählten Farbtönen, in denen diese ästhetisch wirklich atemberaubende Fliese lieferbar ist. Solid Rock ist Protecta vergütet und damit unempfindlich gegen Schmutz und Flecken.

Naturellement expressif

Solid Rock – ce nom seul est une déclaration claire. Et la qualité robuste de cette série est presque gravée dans le marbre. Solid Rock efface les frontières entre l'intérieur et l'extérieur. Purement esthétique, car il fait entrer la force de la nature dans les salles de bains, les foyers et toutes les autres pièces. Mais les possibilités sont également illimitées en matière de pose. Car les carreaux intérieurs combinés aux dalles de terrasse Solid Rock créent des transitions transparentes entre l'intérieur et l'extérieur. Un atout pour les hôtels et les restaurants, mais aussi pour les espaces de vie privés. La structure vivante des carreaux met en valeur les pièces de manière claire et rigoureuse. L'assemblage Move élargit encore la liberté de conception pour les architectes et les concepteurs. Ceci est dû aux différentes teintes soigneusement sélectionnées dans lesquelles ce carreau d'une grande beauté esthétique est disponible. Solid Rock a reçu un traitement Protecta et est donc insensible à la saleté et aux taches.

Naturally expressive

Solid Rock – this name alone is a clear statement. And the robust quality of this series is almost set in stone. Solid Rock eliminates the boundaries between inside and outside. Purely aesthetically, because it brings the power of nature into bathrooms, foyers and all other rooms. But there are also unlimited possibilities when it comes to laying. Because interior tiles in combination with Solid Rock patio tiles create seamless transitions between indoors and outdoors. A highlight for hotels and restaurants, but also in private living areas. The lively structure of the tiles accentuates rooms clearly and stringently. The Move wall bond further expands the design freedom for architects and planners. This is due to the different and carefully selected colour shades in which this aesthetically truly stunning tile is available. Solid Rock is Protecta-upgraded and thus resistant to dirt and stains.





Art.	Nennmaß cote nominale nominal size cm	Herstellmaß cote de fabrication production size mm	m ²	Paket carton box	Palette palette pallet	Beanspr.-Gruppe groupe d'emploi wear resist. group	Norm Norme Standard	Trittsicherheit antidérapance non-slip	Preisgruppe groupe de prix price category
431021							Bla UGL	R10/A+B	W210 (m ²)
430857	5 x 60	46 x 596 x 9	33,333 St pc	39 St pc	46,800 m ²		Bla UGL	R10/A+B	W210 (m ²)
430858			19,899 kg	1,170 m ² 23,283 kg	931,320 kg		Bla UGL	R10/A+B	W210 (m ²)
430859							Bla UGL	R10/A+B	W210 (m ²)
430860							Bla UGL	R10/A+B	W210 (m ²)
431022							Bla UGL	R10/A+B	W210 (m ²)
430861	10 x 60	96 x 596 x 9	16,667 St pc	17 St pc	40,799 m ²		Bla UGL	R10/A+B	W210 (m ²)
430862			20,283 kg	1,020 m ² 20,689 kg	827,560 kg		Bla UGL	R10/A+B	W210 (m ²)
430863							Bla UGL	R10/A+B	W210 (m ²)
430864							Bla UGL	R10/A+B	W210 (m ²)

neu · nouveau · new



Wand- und Bodenfliese | Carreau de mur et de sol | Wall and floor tile
 Feinsteinzeugfliesen unglasiert | grès cérame fin vitrifié non-émaillés | porcelain stoneware tiles unglazed

5 x 60 cm



431021
 dark green
 strukturiert, matt
 structuré, mat
 structured, matt

430857
 silver
 strukturiert, matt
 structuré, mat
 structured, matt

430858
 mud grey
 strukturiert, matt
 structuré, mat
 structured, matt

430859
 natural grey
 strukturiert, matt
 structuré, mat
 structured, matt

430860
 deep grey
 strukturiert, matt
 structuré, mat
 structured, matt

Auftragsfertigung: Rückgabe und/oder Stornierung bestellter Ware nicht möglich.
 Fabrication sur commande : il nous est impossible d'accepter l'annulation de commandes d'articles ou le retour d'articles.
 Make-to-order production: return and/or cancellation of ordered products not possible.

10 x 60 cm



431022
 dark green
 strukturiert, matt
 structuré, mat
 structured, matt

430861
 silver
 strukturiert, matt
 structuré, mat
 structured, matt

430862
 mud grey
 strukturiert, matt
 structuré, mat
 structured, matt

430863
 natural grey
 strukturiert, matt
 structuré, mat
 structured, matt

430864
 deep grey
 strukturiert, matt
 structuré, mat
 structured, matt

Auftragsfertigung: Rückgabe und/oder Stornierung bestellter Ware nicht möglich.
 Fabrication sur commande : il nous est impossible d'accepter l'annulation de commandes d'articles ou le retour d'articles.
 Make-to-order production: return and/or cancellation of ordered products not possible.

Art.	Nennmaß cote nominale nominal size cm	Herstellmaß cote de fabrication production size mm	m ²	Paket carton box	Palette palette pallet	Beanspr.-Gruppe groupe d'emploi wear resist. group	Norm Norme Standard	Trittsicherheit antidérapance non-slip	Preisgruppe groupe de prix price category
431023							Bla UGL	R10/A+B	W186 (m ²)
430865	15 x 60	146 x 596 x 9	11,111 St pc	13 St pc	46,800 m ²		Bla UGL	R10/A+B	W186 (m ²)
430866			19,899 kg	1,170 m ² 23,283 kg	931,320 kg		Bla UGL	R10/A+B	W186 (m ²)
430867							Bla UGL	R10/A+B	W186 (m ²)
430868							Bla UGL	R10/A+B	W186 (m ²)
431024							Bla UGL	R10/A+B	W102 (m ²)
430869	30 x 60	297 x 596 x 9	5,556 St pc	7 St pc	50,396 m ²		Bla UGL	R10/A+B	W102 (m ²)
430870			19,841 kg	1,260 m ² 25,000 kg	999,880 kg		Bla UGL	R10/A+B	W102 (m ²)
430871							Bla UGL	R10/A+B	W102 (m ²)
430872							Bla UGL	R10/A+B	W102 (m ²)
431025							Bla UGL	R10/A+B	W117 (m ²)
430873	60 x 60	596 x 596 x 9	2,778 St pc	3 St pc	43,197 m ²		Bla UGL	R10/A+B	W117 (m ²)
430874			19,288 kg	1,080 m ² 20,829 kg	833,160 kg		Bla UGL	R10/A+B	W117 (m ²)
430875							Bla UGL	R10/A+B	W117 (m ²)
430876							Bla UGL	R10/A+B	W117 (m ²)

Wand- und Bodenfliese | Carreau de mur et de sol | Wall and floor tile

Feinsteinzeugfliesen unglasiert | grès cérame fin vitrifié non-émaillés | porcelain stoneware tiles unglazed

15 x 60 cm



431023

dark green
strukturiert, matt
structuré, mat
structured, matt

430866

mud grey
strukturiert, matt
structuré, mat
structured, matt

430868

deep grey
strukturiert, matt
structuré, mat
structured, matt



430865

silver
strukturiert, matt
structuré, mat
structured, matt

430867

natural grey
strukturiert, matt
structuré, mat
structured, matt

Auftragsfertigung: Rückgabe und/oder Stornierung bestellter Ware nicht möglich.
Fabrication sur commande : il nous est impossible d'accepter l'annulation de commandes d'articles ou le retour d'articles.
Make-to-order production: return and/or cancellation of ordered products not possible.

30 x 60 cm



431024

dark green
strukturiert, matt
structuré, mat
structured, matt

430870

mud grey
strukturiert, matt
structuré, mat
structured, matt

430872

deep grey
strukturiert, matt
structuré, mat
structured, matt



430869

silver
strukturiert, matt
structuré, mat
structured, matt

430871

natural grey
strukturiert, matt
structuré, mat
structured, matt

60 x 60 cm



431025

dark green
strukturiert, matt
structuré, mat
structured, matt

430874

mud grey
strukturiert, matt
structuré, mat
structured, matt

430876

deep grey
strukturiert, matt
structuré, mat
structured, matt



430873

silver
strukturiert, matt
structuré, mat
structured, matt

430875

natural grey
strukturiert, matt
structuré, mat
structured, matt

Art.	Nennmaß cote nominale nominal size cm	Herstellmaß cote de fabrication production size mm	m ²	Paket carton box	Palette palette pallet	Beanspr.-Gruppe groupe d'emploi wear resist. group	Norm Norme Standard	Trittsicherheit antidérapance non-slip	Preisgruppe groupe de prix price category
431026							Bla UGL	R10/A+B	W156 (m ²)
430877	60 x 120	596 x 1194 x 9	1,388 St pc	2 St pc	50,432 m ²		Bla UGL	R10/A+B	W156 (m ²)
430878			21,514 / kg	1,44 m ²	31,000 kg	1.085,000 kg	Bla UGL	R10/A+B	W156 (m ²)
430879							Bla UGL	R10/A+B	W156 (m ²)
430880							Bla UGL	R10/A+B	W156 (m ²)

neu · nouveau · new



dark green

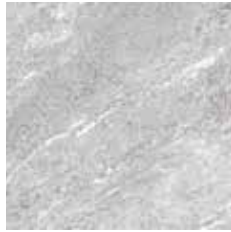

silver



mud grey

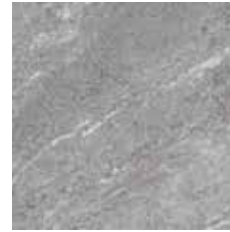

natural grey



deep grey



Wand- und Bodenfliese | Carreau de mur et de sol | Wall and floor tile

Feinsteinzeugfliesen unglasiert | grès cérame fin vitrifié non-émaillés | porcelain stoneware tiles unglazed

60 x 120 cm

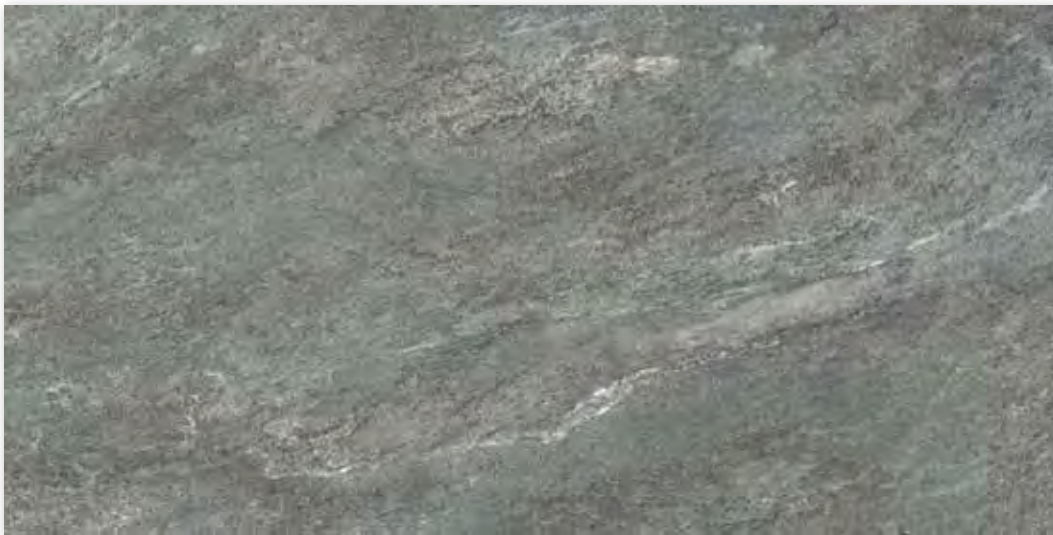

431026

dark green
strukturiert, matt
structuré, mat
structured, matt

430877

silver
strukturiert, matt
structuré, mat
structured, matt

430878

mud grey
strukturiert, matt
structuré, mat
structured, matt

430879

natural grey
strukturiert, matt
structuré, mat
structured, matt

430880

deep grey
strukturiert, matt
structuré, mat
structured, matt

Art.	Nennmaß cote nominale nominal size cm	Herstellmaß cote de fabrication production size mm	m ²	Paket carton box	Palette palette pallet	Beanspr.-Gruppe groupe d'emploi wear resist. group	Norm Norme Standard	Trittsicherheit antidérapance non-slip	Preisgruppe groupe de prix price category
431027							Bla UGL	R11/B	W240 (m ²)
430881	60 x 60	596 x 596 x 20	2,778 St pc	2 St pc	21,598 m ²		Bla UGL	R11/B	W240 (m ²)
430882			47,226 kg	0,720 m ² 34,000 kg	1.020,000 kg		Bla UGL	R11/B	W240 (m ²)
430883							Bla UGL	R11/B	W240 (m ²)
430884							Bla UGL	R11/B	W240 (m ²)
431028							Bla UGL	R11/B	W261 (m ²)
430885	60 x 120	596 x 1194 x 20	1,388 St pc	1 St pc	25,200 m ²		Bla UGL	R11/B	W261 (m ²)
430886			45,110 kg	0,720 m ² 32,500 kg	1.137,500 kg		Bla UGL	R11/B	W261 (m ²)
430887							Bla UGL	R11/B	W261 (m ²)
430888							Bla UGL	R11/B	W261 (m ²)

Terrassenplatten | dalles de terrasse | patio tiles*

Feinsteinzeugfliesen unglasiert | grès cérame fin vitrifié non-émaillés | porcelain stoneware tiles unglazed

60 x 60 cm

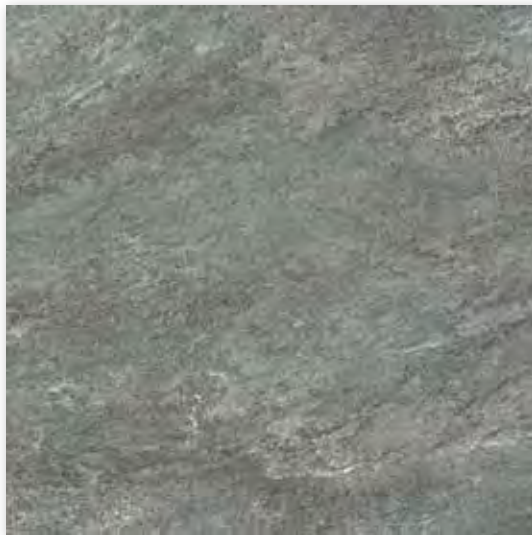

431027

dark green
strukturiert, matt
structuré, mat
structured, matt

430881

silver
strukturiert, matt
structuré, mat
structured, matt

430882

mud grey
strukturiert, matt
structuré, mat
structured, matt

430883

natural grey
strukturiert, matt
structuré, mat
structured, matt

430884

deep grey
strukturiert, matt
structuré, mat
structured, matt

60 x 120 cm **

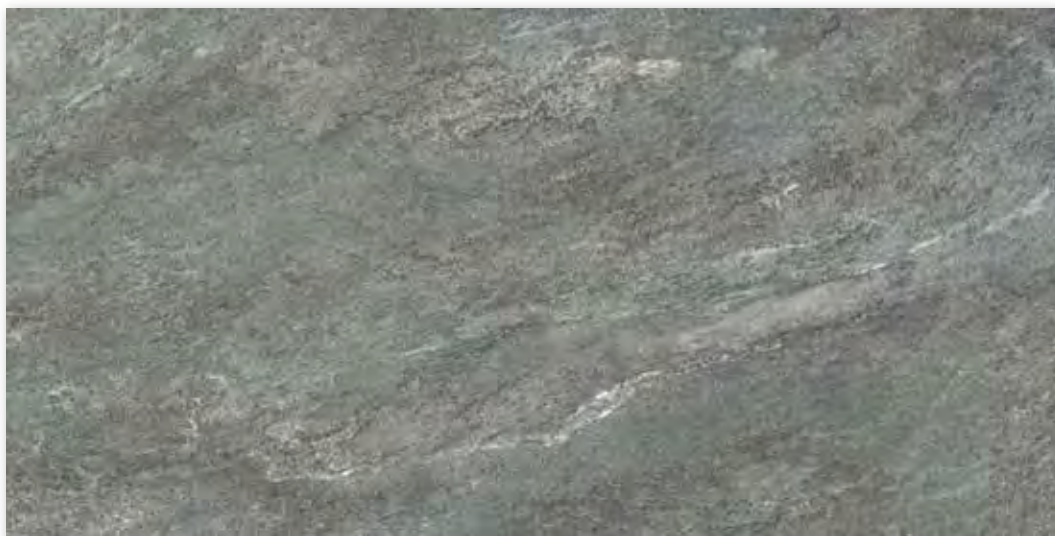

431028

dark green
strukturiert, matt
structuré, mat
structured, matt

430885

silver
strukturiert, matt
structuré, mat
structured, matt

430886

mud grey
strukturiert, matt
structuré, mat
structured, matt

430887

natural grey
strukturiert, matt
structuré, mat
structured, matt

430888

deep grey
strukturiert, matt
structuré, mat
structured, matt

* Hohes Gewicht! Karton bitte nur zu Zweit transportieren.
* Poids élevé ; a transporter par deux personnes seulement.
* High weight only to carry with two persons.

** Achtung: Sonderpalette. Keine Rücknahme, kein Umtausch.
** Attention : palette spéciale. Pas de retour, pas d'échange.
** Please note: special pallet. No return, no exchange.

Art.	Nennmaß cote nominale nominal size cm	Herstellmaß cote de fabrication production size mm	m	Paket carton box	Palette palette pallet	Beanspr.-Gruppe groupe d'emploi wear resist. group	Norm Norme Standard	Trittsicherheit antidérapance non-slip	Preisgruppe groupe de prix price category
431029							Bla UGL	R10/A+B	W488 (St pc)
430897	15 x 60	148 x 598 x 9	2,000 St pc	2 St pc			Bla UGL	R10/A+B	W488 (St pc)
430898			2,780 / kg	1,000 m	2,780 kg		Bla UGL	R10/A+B	W488 (St pc)
430899							Bla UGL	R10/A+B	W488 (St pc)
430900							Bla UGL	R10/A+B	W488 (St pc)

Dekorationselemente | éléments décoratifs | decoration elements

Bordüre Move | bordure Move | border Move

Feinsteinzeugfliesen unglasiert | grès cérame fin vitrifié non-émaillés | porcelain stoneware tiles unglazed

15 x 60 cm



431029
dark green
strukturiert, matt
structuré, mat
structured, matt

15 x 60 cm



430897
silver
strukturiert, matt
structuré, mat
structured, matt



430898
mud grey
strukturiert, matt
structuré, mat
structured, matt



430899
natural grey
strukturiert, matt
structuré, mat
structured, matt



430900
deep grey
strukturiert, matt
structuré, mat
structured, matt

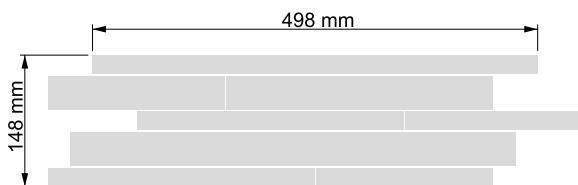

Verklebung rückseitig auf Glasfasernetz,
Bogen: 148 x 598 mm
Collée sur trame en fibre de verre à l'envers,
Feuille: 148 x 598 mm
Glass fibre net on reverse side,
Sheet: 148 x 598 mm

Abgabe der Dekorationselemente ausschließlich in vollen Kartons.
Éléments décoratifs uniquement livrables en cartons entiers.
Decoration elements only available in full boxes.

Art.	Nennmaß cote nominale nominal size cm	Herstellmaß cote de fabrication production size mm	m	Paket carton box	Palette palette pallet	Beanspr.-Gruppe groupe d'emploi wear resist. group	Norm Norme Standard	Trittsicherheit antidérapance non-slip	Preisgruppe groupe de prix price category
431030							Bla UGL	R10/A+B	W473 (St pc)
430893	30 x 60	297 x 596 x 9	1,667 St pc	7 St pc			Bla UGL	R10/A+B	W473 (St pc)
430894			5,973 / kg	4,199 m	25,081 kg		Bla UGL	R10/A+B	W473 (St pc)
430895							Bla UGL	R10/A+B	W473 (St pc)
430896							Bla UGL	R10/A+B	W473 (St pc)
431031							Bla UGL		W439 (St pc)
430889	7x 60	70 x 596 x 9	1,667 St pc	22 St pc			Bla UGL		W439 (St pc)
430890			1,357 / kg	13,197 m	17,908 kg		Bla UGL		W439 (St pc)
430891							Bla UGL		W439 (St pc)
430892							Bla UGL		W439 (St pc)

Treppenfliese | nez de marche | stair tile

Feinsteinzeugfliesen unglasiert | grès cérame fin vitrifié non-émaillés | porcelain stoneware tiles unglazed

30 x 60 cm



431030
dark green
strukturiert, matt
structuré, mat
structured, matt

430895
natural grey
strukturiert, matt
structuré, mat
structured, matt

430893
silver
strukturiert, matt
structuré, mat
structured, matt

430896
deep grey
strukturiert, matt
structuré, mat
structured, matt

430894
mud grey
strukturiert, matt
structuré, mat
structured, matt

Auftragsfertigung: Rückgabe und/oder Stornierung bestellter Ware nicht möglich.

Fabrication sur commande : il nous est impossible d'accepter l'annulation de commandes d'articles ou le retour d'articles.

Make-to-order production: return and/or cancellation of ordered products not possible.

Sockel, gerundet | plinthe, arrondie | skirting, rounded

Feinsteinzeugfliesen unglasiert | grès cérame fin vitrifié non-émaillés | porcelain stoneware tiles unglazed

7 x 60 cm

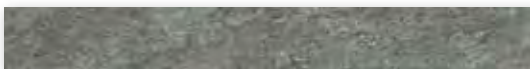

431031
dark green
strukturiert, matt
structuré, mat
structured, matt

430891
natural grey
strukturiert, matt
structuré, mat
structured, matt

430889
silver
strukturiert, matt
structuré, mat
structured, matt

430892
deep grey
strukturiert, matt
structuré, mat
structured, matt

430890
mud grey
strukturiert, matt
structuré, mat
structured, matt

Art.	Nennmaß cote nominale nominal size cm	Herstellmaß cote de fabrication production size mm	m ²	Paket carton box	Palette palette pallet	Beanspr.-Gruppe groupe d'emploi wear resist. group	Norm Norme Standard	Trittsicherheit antidérapance non-slip	Preisgruppe groupe de prix price category
431020							Bla UGL	R10/A+B	W303 (m ²)
430853	5 x 5	47 x 47 x 9	11,111 Bögen plaques sheets	12 Bögen plaques sheets	32,400 m ²		Bla UGL	R10/A+B	W303 (m ²)
430854			19,833 kg	1,080 m ² 21,420 kg	642,600 kg		Bla UGL	R10/A+B	W303 (m ²)
430855							Bla UGL	R10/A+B	W303 (m ²)
430856							Bla UGL	R10/A+B	W303 (m ²)

Mosaik | mosaïque | mosaic

Feinsteinzeugfliesen unglasiert | grès cérame fin vitrifié non-émaillés | porcelain stoneware tiles unglazed

5 x 5 cm

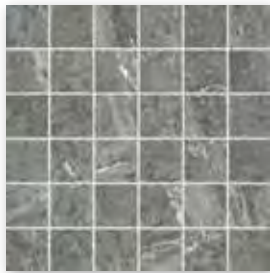

431020
dark green
strukturiert, matt
structuré, mat
structured, matt



430853
silver
strukturiert, matt
structuré, mat
structured, matt



430854
mud grey
strukturiert, matt
structuré, mat
structured, matt



430855
natural grey
strukturiert, matt
structuré, mat
structured, matt

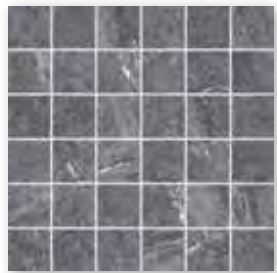

430856
deep grey
strukturiert, matt
structuré, mat
structured, matt

Mosaik, Verklebung rückseitig auf Glasfasernetz
Bogen: 297 x 297 mm

Mosaïque, collée sur trame en fibre de verre à l'envers, Feuille: 297 x 297 mm

Mosaic, glass fibre net on reverse side
Sheet: 297 x 297 mm



Urbaner Chic in trendiger Beton-Optik

Vier Farben, zwei Formate – so puristisch versteht Soul zu überzeugen. Für ein zeitloses Interieur oder einen Style mit engem Bezug zur Natur. Je nach Farbstellung lassen sich hier unterschiedliche Wirkungen erzielen. In Braun, Anthrazit, Basalt, Zementgrau stehen Fliesen in klassischen 30 x 60 cm und quadratischen 60 x 60 cm mit Trittsicherheit R9 zur Verfügung. Ergänzt wird die Formatpalette durch passende Treppenfliesen in 30 x 60 cm, Sockel und 5 x 5 cm-Mosaik – für eine durchgehend einheitliche Gestaltung an Wand, Boden und in Nassbereichen.

Le chic urbain du look béton

Quatre teintes, deux formats suffisent à Soul pour convaincre. Pour un intérieur intemporel ou un style proche de la nature. Différentes combinaisons de teintes permettent d'obtenir différents effets. Les carreaux antidérapants R9 sont disponibles en brun, anthracite, basalte et gris ciment au format rectangulaire de 30 x 60 cm ou carré de 60 x 60 cm. La gamme est complétée par les nez de marche de 30 x 60 cm, les plinthes et les mosaïques de 5 x 5 cm pour une conception uniforme des murs, sols et espaces humides.

Urban chic with a trendy concrete look

Available in four colors and two formats – Soul is convincingly puristic. For a timeless interior or a style with a close connection to nature. Depending on the colors, various effects can be achieved here. Tiles in classic 30 x 60 cm and square 60 x 60 cm formats with R9 slip resistance are available in brown, anthracite, basalt and cement-grey. The range of formats is supplemented by matching stair tiles in 30 x 60 cm, skirtings and 5 x 5 cm mosaics – for a consistently uniform design on walls, floors and in wet areas.





Studioaufnahme · photo prise en studio · studio photo / Architekt · architecte · architect: STELLWERK architekten, Dresden, Deutschland
Allemagne · Germany / Serie · série · series: Soul / Photo: Jochen Stüber

Art.	Nennmaß cote nominale nominal size cm	Herstellmaß cote de fabrication production size mm	m ²	Paket carton box	Palette palette pallet	Beanspr.-Gruppe groupe d'emploi wear resist. group	Norm Norme Standard	Trittsicherheit antidérapance non-slip	Preisgruppe groupe de prix price category
434854							Bla UGL	R9	C128 (m ²)
434855	30 x 60	297 x 597 x 10,5	5,556 St pc	6 St pc	43,197 m ²		Bla UGL	R9	C128 (m ²)
434856			23,224 kg	1,080 m ² 25,080 kg	1.003,200 kg		Bla UGL	R9	C128 (m ²)
434857							Bla UGL	R9	C128 (m ²)
434858							Bla UGL	R9	C152 (m ²)
434859	60 x 60	597 x 597 x 10,5	2,778 St pc	3 St pc	38,877 m ²		Bla UGL	R9	C152 (m ²)
434860			23,769 kg	1,080 m ² 25,668 kg	924,048 kg		Bla UGL	R9	C152 (m ²)
434861							Bla UGL	R9	C152 (m ²)



braun
brun
brown

V4



anthrazit
anthracite

V4



basalt
basalte
basalt

V3

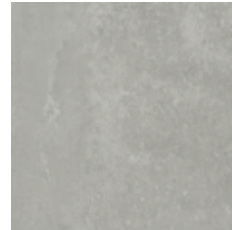

zementgrau
gris ciment
cement-grey

V3

Boden- und Wandfliese | carreau de sol et de mur | floor and wall tile

Feinsteinzeugfliesen unglasiert | grès cérame fin vitrifié non-émaillés | porcelain stoneware tiles unglazed

30 x 60 cm



434854

braun | brun | brown
eben, matt | lisse, mat | smooth, matt



434855

anthrazit | anthracite
eben, matt | lisse, mat | smooth, matt

434856

basalt | basalte | basalt
eben, matt | lisse, mat | smooth, matt

434857

zementgrau | gris ciment | cement-grey
eben, matt | lisse, mat | smooth, matt

60 x 60 cm



434858

braun | brun | brown
eben, matt | lisse, mat | smooth, matt



434859

anthrazit | anthracite
eben, matt | lisse, mat | smooth, matt

434860

basalt | basalte | basalt
eben, matt | lisse, mat | smooth, matt

434861

zementgrau | gris ciment | cement-grey
eben, matt | lisse, mat | smooth, matt

Art.	Nennmaß cote nominale nominal size cm	Herstellmaß cote de fabrication production size mm	m	Paket carton box	Palette palette pallet	Beanspr.-Gruppe groupe d'emploi wear resist. group	Norm Norme Standard	Trittsicherheit antidérapance non-slip	Preisgruppe groupe de prix price category
434862							Bla UGL	R9	C474 (St pc)
434863	30 x 60	297 x 597 x 10,5	1,667 St pc	6 St pc			Bla UGL	R9	C474 (St pc)
434864			6,968 kg	3,599 m	25,080 kg		Bla UGL	R9	C474 (St pc)
434865							Bla UGL	R9	C474 (St pc)
434866							Bla UGL		C440 (St pc)
434867	7 x 60	70 x 597 x 10,5	1,667 St pc	22 St pc			Bla UGL		C440 (St pc)
434868			1,584 kg	13,197 m	20,900 kg		Bla UGL		C440 (St pc)
434869							Bla UGL		C440 (St pc)

Treppenfliese | nez de marche | stair tile

Feinsteinzeugfliesen unglasiert | grès cérame fin vitrifié non-émaillés | porcelain stoneware tiles unglazed

30 x 60 cm



434862

braun | brun | brown
eben, matt | lisse, mat | smooth, matt



434863

anthrazit | anthracite
eben, matt | lisse, mat | smooth, matt

434864

basalt | basalte | basalt
eben, matt | lisse, mat | smooth, matt

434865

zementgrau | gris ciment | cement-grey
eben, matt | lisse, mat | smooth, matt

Auftragsfertigung: Rückgabe und/oder
Stornierung bestellter Ware nicht möglich.

Fabrication sur commande : il nous est
impossible d'accepter l'annulation de
commandes d'articles ou le retour d'articles.

Make-to-order production: return and/or
cancellation of ordered products not possible.

Sockel, gerundet | plinthe, arrondie | skirting, rounded

Feinsteinzeugfliesen unglasiert | grès cérame fin vitrifié non-émaillés | porcelain stoneware tiles unglazed

7 x 60 cm



434866

braun | brun | brown
eben, matt | lisse, mat | smooth, matt



434867

anthrazit | anthracite
eben, matt | lisse, mat | smooth, matt

434868

basalt | basalte | basalt
eben, matt | lisse, mat | smooth, matt

434869

zementgrau | gris ciment | cement-grey
eben, matt | lisse, mat | smooth, matt

Art.	Nennmaß cote nominale nominal size cm	Herstellmaß cote de fabrication production size mm	m ²	Paket carton box	Palette palette pallet	Beanspr.-Gruppe groupe d'emploi wear resist. group	Norm Norme Standard	Trittsicherheit antidérapance non-slip	Preisgruppe groupe de prix price category
434850							Bla UGL	R10/B	C347 (m ²)
434851	5 x 5	47 x 47 x 10,5	11,111 Bögen plaques sheets	11 Bögen plaques sheets	29,700 m ²		Bla UGL	R10/B	C347 (m ²)
434852			22,222 kg	0,990 m ² 22,000 kg	660,000 kg		Bla UGL	R10/B	C347 (m ²)
434853							Bla UGL	R10/B	C347 (m ²)

Mosaik | Mosaique | Mosaic

Feinsteinzeugfliesen unglasiert | grès cérame fin vitrifié non-émaillés | porcelain stoneware tiles unglazed

5 x 5 cm

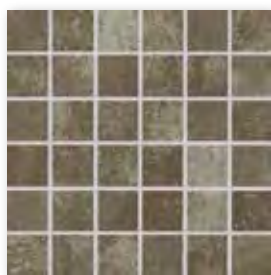

434850
braun | brun | brown
eben, matt
lisse, mat
smooth, matt

V4

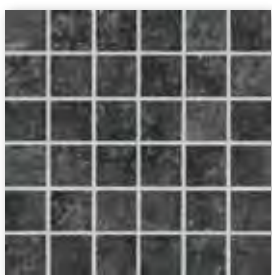

434851
anthrazit | anthracite
eben, matt
lisse, mat
smooth, matt

V4



434852
basalt | basalte | basalt
eben, matt
lisse, mat
smooth, matt

V3

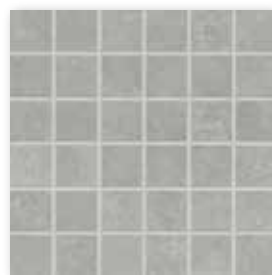

434853
zementgrau | gris ciment | cement-grey
eben, matt
lisse, mat
smooth, matt

V3



Mosaik, Verklebung rückseitig auf Glasfasernetz,
Bogen: 297 x 297 mm

Mosaique, collée sur trame en fibre de verre à
l'envers, Feuille : 297 x 297 mm

Mosaic, glass fibre net on reverse side,
Sheet: 297 x 297 mm



Studioaufnahme · photo prise en studio · studio photo / Architekt · architecte · architect: STELLWERK architekten, Dresden, Deutschland /
Serie · série · series: Soul / Photo: Jochen Stüber





Wenn Räume erzählen

Die Serie Stories kommt durch und durch urban daher: mit ihrer Optik von Zement, ihren zeitlosen Grautönen, ihren vielen kreativen Möglichkeiten und ihrer faszinierenden Großzügigkeit. Über die bewusste Kombination von Serienkomponenten spiegeln sich die individuellen Vorlieben der Bewohner wider: Der Raum erzählt Geschichten. Die Bodenfliesen überzeugen durch ihre soften Nuancierungen und ihre unverfälschte, steinmatte Charakteristik von Zement. Für ein reizvoll urbanes Flair. Spannend wird die Serie Stories durch ihre zwei Dekore: das Schnittdekor Tangram und das Volldekor Ivy.

Lorsque les pièces racontent une histoire

La Série Stories est urbaine de A à Z : avec son aspect ciment et ses tons gris intemporels, ses nombreuses possibilités en matière de création et une fascinante générosité. La combinaison des composants de cette série reflète les goûts de ses occupants : la pièce raconte alors une histoire. Ces carreaux de sol sauront convaincre par leurs nuances douces et la pureté minérale du ciment. Pour donner aux espaces un charme urbain. Deux passionnants nouveaux décors viennent compléter la Série Stories : le décor découpé Tangram et le décor intégral Ivy.

When rooms tell stories

The series Stories is urban to the core: with its cement-like look, timeless grey shades, countless creative options and fascinating opulence. The intentional combination of components of the series reflects the residents' individual preferences: rooms literally tell stories. The floor tiles are convincing thanks to their soft nuances and unadulterated, stone-matt cement characteristics, thus creating an appealingly urban flair. What also makes the series Stories interesting is its two decoration variants: the Tangram cut decor and the Ivy full decor.

Art.	Nennmaß cote nominale nominal size cm	Herstellmaß cote de fabrication production size mm	m ²	Paket carton box	Palette palette pallet	Beanspr.-Gruppe groupe d'emploi wear resist. group	Norm Norme Standard	Trittsicherheit antidérapance non-slip	Preisgruppe groupe de prix price category
203431H	30 x 60	297 x 597 x 6	5,556 St pc	13 St pc	112,311 m ²		BIII GL		W90 (m ²)
203433H			10,279 kg	2,340 m ² 24,050 kg	1.154,400 kg		BIII GL		W90 (m ²)
363352H	35 x 100	347 x 997 x 6	2,857 St pc	5 St pc	70,000 m ²		BIII GL		W156 (m ²)
363353H			10,108 kg	1,750 m ² 17,690 kg	707,600 kg		BIII GL		W156 (m ²)

Wandfliese | carreau de mur | wall tile
Steingut glasiert | faïence émaillée | earthenware glazed

30 x 60 cm

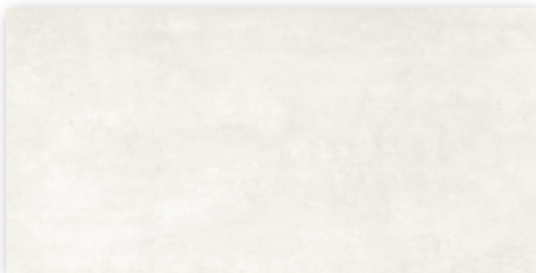

203431H
pearl
strukturiert, seidenmatt | structuré, satiné | structured, silky-matt

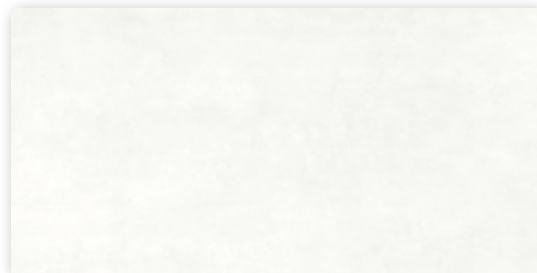

203433H
soft grey
strukturiert, seidenmatt | structuré, satiné | structured, silky-matt

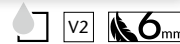

35 x 100 cm

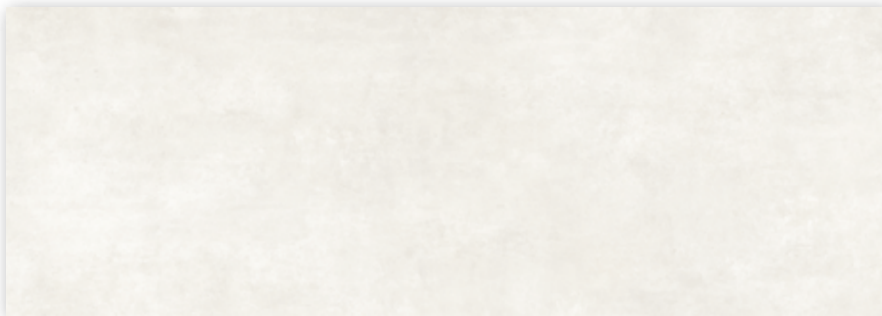

363352H
pearl
strukturiert, seidenmatt | structuré, satiné | structured, silky-matt

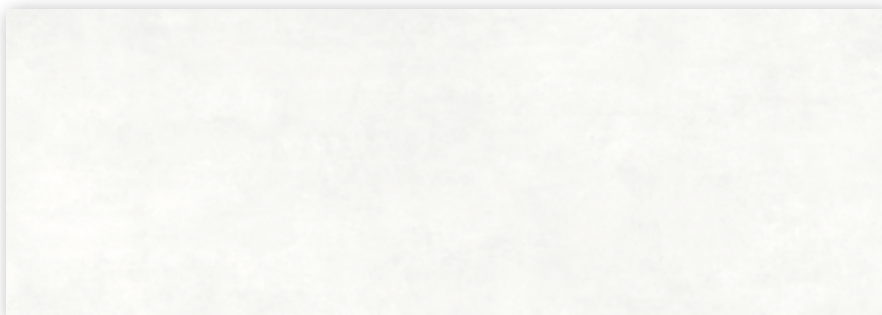
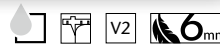

363353H
soft grey
strukturiert, seidenmatt | structuré, satiné | structured, silky-matt



Art.	Nennmaß cote nominale nominal size cm	Herstellmaß cote de fabrication production size mm	m ²	Paket carton box	Palette palette pallet	Beanspr.-Gruppe groupe d'emploi wear resist. group	Norm Norme Standard	Trittsicherheit antidérapance non-slip	Preisgruppe groupe de prix price category
203432H	30 x 60	297 x 597 x 6	5,556 St pc	13 St pc	112,311 m ²		BIII GL		W102 (m ²)
203434H			10,279 kg	2,340 m ² 24,050 kg	1.154,40 kg		BIII GL		W102 (m ²)
363354H	35 x 100	347 x 997 x 6	2,857 St pc	5 St pc	70,000 m ²		BIII GL		W162 (m ²)
363355H			10,108 kg	1,750 m ² 17,690 kg	707,600 kg		BIII GL		W162 (m ²)

Dekorationselemente | éléments décoratifs | decoration elements

Volldekor Ivy | Volldekor carreau décoratif Ivy | decorative element Ivy

Steingut glasiert | faïence émaillée | earthenware glazed

30 x 60 cm



203432H

soft sepia

strukturiert, seidenmatt | structuré, satiné | structured, silky-matt



203434H

soft concrete

strukturiert, seidenmatt | structuré, satiné | structured, silky-matt

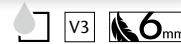

35 x 100 cm



363354H

soft sepia

strukturiert, seidenmatt | structuré, satiné | structured, silky-matt



363355H

soft concrete

strukturiert, seidenmatt | structuré, satiné | structured, silky-matt

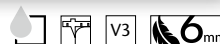

Abgabe der Dekorationselemente ausschließlich in vollen Kartons.
Eléments décoratifs uniquement livrables en cartons entiers.
Decoration elements only available in full boxes.

Art.	Nennmaß cote nominale nominal size cm	Herstellmaß cote de fabrication production size mm	m	Paket carton box	Palette palette pallet	Beanspr.-Gruppe groupe d'emploi wear resist. group	Norm Norme Standard	Trittsicherheit antidérapance non-slip	Preisgruppe groupe de prix price category
363356							Bla UGL	R10/A	W501 (St pc)
363357	30 x 30	297 x 297 x 6	3,333 Bögen plaques sheets	3 Bögen plaques sheets			Bla UGL	R10/A	W501 (St pc)
363358			3,776 kg	0,900 m 3,399 kg			Bla UGL	R10/A	W501 (St pc)
363359							Bla UGL	R10/A	W501 (St pc)

Dekorationselemente | éléments décoratifs | decoration elements

Mosaikmatte Tangram | mosaïque Tangram | mosaic sheet Tangram

Feinsteinzeugfliesen unglasiert | grès cérame fin vitrifié non-émaillés | porcelain stoneware tiles unglazed

30 x 30 cm



363356
ivory
strukturiert, matt
structuré, mat
structured, matt



363357
concrete
strukturiert, matt
structuré, mat
structured, matt



363358
sepia
strukturiert, matt
structuré, mat
structured, matt

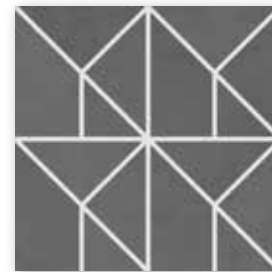

363359
anthracite
strukturiert, matt
structuré, mat
structured, matt



Mosaik, Verklebung rückseitig auf Glasfasernetz,
Bogen: 297 x 297 mm

Mosaïque, collée sur trame en fibre de verre à
l'envers, Feuille : 297 x 297 mm

Mosaic, glass fibre net on reverse side,
Sheet: 297 x 297 mm

Abgabe der Dekorationselemente ausschließlich in vollen Kartons.
Éléments décoratifs uniquement livrables en cartons entiers.
Decoration elements only available in full boxes.

Art.	Nennmaß cote nominale nominal size cm	Herstellmaß cote de fabrication production size mm	m ²	Paket carton box	Palette palette pallet	Beanspr.-Gruppe groupe d'emploi wear resist. group	Norm Norme Standard	Trittsicherheit antidérapance non-slip	Preisgruppe groupe de prix price category
431630H							Bla UGL	R10/A	W111 (m ²)
431631H	30 x 60	297 x 597 x 9	5,556 St pc	7 St pc	50,396 m ²		Bla UGL	R10/A	W111 (m ²)
431632H			19,907 kg	1,260 m ² 25,081 kg	1.003,240 kg		Bla UGL	R10/A	W111 (m ²)
431633H							Bla UGL	R10/A	W111 (m ²)
431634H							Bla UGL	R10/A	W123 (m ²)
431635H	60 x 60	597 x 597 x 9	2,778 St pc	3 St pc	45,356 m ²		Bla UGL	R10/A	W123 (m ²)
431636H			20,371 kg	1,080 m ² 21,999 kg	923,950 kg		Bla UGL	R10/A	W123 (m ²)
431637H							Bla UGL	R10/A	W123 (m ²)



ivory



concrete



sepia



anthracite



Bodenfliese | carreau de sol | floor tile

Feinsteinzeugfliesen unglasiert | grès cérame fin vitrifié non-émaillés | porcelain stoneware tiles unglazed

30 x 60 cm



431630H

ivory
strukturiert, matt
structuré, mat
structured, matt

431632H

concrete
strukturiert, matt
structuré, mat
structured, matt

431631H

sepia
strukturiert, matt
structuré, mat
structured, matt

431633H

anthracite
strukturiert, matt
structuré, mat
structured, matt

60 x 60 cm



431634H

ivory
strukturiert, matt
structuré, mat
structured, matt

431636H

concrete
strukturiert, matt
structuré, mat
structured, matt

431635H

sepia
strukturiert, matt
structuré, mat
structured, matt

431637H

anthracite
strukturiert, matt
structuré, mat
structured, matt

Art.	Nennmaß cote nominale nominal size cm	Herstellmaß cote de fabrication production size mm	m ²	Paket carton box	Palette palette pallet	Beanspr.-Gruppe groupe d'emploi wear resist. group	Norm Norme Standard	Trittsicherheit antidérapance non-slip	Preisgruppe groupe de prix price category
432323							Bla UGL	R10/A	W171 (m ²)
432324	100 x 100	997 x 997 x 6	1,000 St pc	2 St pc	50,000 m ²		Bla UGL	R10/A	W171 (m ²)
432325			14,100 kg	2,000 m ² 28,200 kg	705,000 kg		Bla UGL	R10/A	W171 (m ²)
432326							Bla UGL	R10/A	W171 (m ²)



ivory



concrete



sepia



anthracite



Bodenfliese | carreau de sol | floor tile

Feinsteinzeugfliesen unglasiert | grès cérame fin vitrifié non-émaillés | porcelain stoneware tiles unglazed

100 x 100 cm

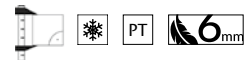

432323

ivory
strukturiert, matt
structuré, mat
structured, matt

432324

concrete
strukturiert, matt
structuré, mat
structured, matt

432325

sepia
strukturiert, matt
structuré, mat
structured, matt

432326

anthracite
strukturiert, matt
structuré, mat
structured, matt

Achtung: Sonderpalette. Keine Rücknahme, kein Umtausch.
Attention : palette spéciale. Pas de retour, pas d'échange.
Please note: special pallet. No return, no exchange.

Geeignet für den Einsatz in Bereichen mit Belastungsgruppe 1.
Se prête à l'utilisation dans les zones de la classe de sollicitation 1.
Suitable for the use in areas with stress group 1.

Art.	Nennmaß cote nominale nominal size cm	Herstellmaß cote de fabrication production size mm	m	Paket carton box	Palette palette pallet	Beanspr.-Gruppe groupe d'emploi wear resist. group	Norm Norme Standard	Trittsicherheit antidérapance non-slip	Preisgruppe groupe de prix price category
431638H							Bla UGL	R10/A	W473 (St pc)
431639H	30 x 60	297 x 597 x 9	1,667 St pc	7 St pc			Bla UGL	R10/A	W473 (St pc)
431640H			5,973 kg	4,199 m	25,081 kg		Bla UGL	R10/A	W473 (St pc)
431641H							Bla UGL	R10/A	W473 (St pc)
431642H							Bla UGL		W439 (St pc)
431643H	7 x 60	70 x 597 x 9	1,667 St pc	15 St pc			Bla UGL		W439 (St pc)
431644H			1,357 kg	8,998 m	12,210 kg		Bla UGL		W439 (St pc)
431645H							Bla UGL		W439 (St pc)

Treppenfliese | nez de marche | stair tile

Feinsteinzeugfliesen unglasiert | grès cérame fin vitrifié non-émaillés | porcelain stoneware tiles unglazed

30 x 60 cm



431638H

ivory
strukturiert, matt
structuré, mat
structured, matt

431640H

concrete
strukturiert, matt
structuré, mat
structured, matt

431639H

sepia
strukturiert, matt
structuré, mat
structured, matt

431641H

anthracite
strukturiert, matt
structuré, mat
structured, matt

Auftragsfertigung: Rückgabe und/oder Stornierung bestellter Ware nicht möglich.

Fabrication sur commande : il nous est impossible d'accepter l'annulation de commandes d'articles ou le retour d'articles.

Make-to-order production: return and/or cancellation of ordered products not possible.

Sockel, gerundet | plinthe, arrondie | skirting, rounded

Feinsteinzeugfliesen unglasiert | grès cérame fin vitrifié non-émaillés | porcelain stoneware tiles unglazed

7 x 60 cm

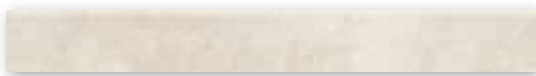

431642H

ivory
strukturiert, matt
structuré, mat
structured, matt

431644H

concrete
strukturiert, matt
structuré, mat
structured, matt

431643H

sepia
strukturiert, matt
structuré, mat
structured, matt

431645H

anthracite
strukturiert, matt
structuré, mat
structured, matt

Art.	Nennmaß cote nominale nominal size cm	Herstellmaß cote de fabrication production size mm	m ²	Paket carton box	Palette palette pallet	Beanspr.-Gruppe groupe d'emploi wear resist. group	Norm Norme Standard	Trittsicherheit antidérapance non-slip	Preisgruppe groupe de prix price category
432335H							Bla UGL	R10/B	W177 (m ²)
432336H	5 x 5	47 x 47 x 6,5	11 Bögen plaques sheets	11 Bögen plaques sheets	64,000 m ²		Bla UGL	R10/B	W177 (m ²)
432337H			12,331 kg	1,000 m ² 12,331 kg	789,184 kg		Bla UGL	R10/B	W177 (m ²)
432338H							Bla UGL	R10/B	W177 (m ²)
434986H							Bla UGL	R11/B	W240 (m ²)
434987H	60 x 60	597 x 597 x 20	2,778 St pc	2 St pc	21,598 m ²		Bla UGL	R11/B	W240 (m ²)
434988H			45,273 kg	0,720 m ² 32,500 kg	977,820 kg		Bla UGL	R11/B	W240 (m ²)
434989H							Bla UGL	R11/B	W240 (m ²)

Mosaik | mosaïque | mosaic

Feinsteinzeugfliesen unglasiert | grès cérame fin vitrifié non-émaillés | porcelain stoneware tiles unglazed

5 x 5 cm



432335H

ivory
strukturiert, matt | structuré, mat |
structured, matt



432336H

concrete
strukturiert, matt | structuré, mat |
structured, matt



432337H

sepia
strukturiert, matt | structuré, mat |
structured, matt

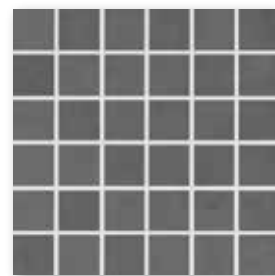

432338H

anthracite
strukturiert, matt | structuré, mat |
structured, matt



Mosaik, rückseitig thermoplastisch verklebt
Bogen: 297 x 297 mm

Mosaïque, collage thermoplastique sur l'envers
Feuille: 297 x 297 mm

Mosaic, glued thermo-plastically on back
Sheet: 297 x 297 mm

Terrassenplatte | dalle de terrasse | patio tile*

Feinsteinzeugfliesen unglasiert | grès cérame fin vitrifié non-émaillés | porcelain stoneware tiles unglazed

60 x 60 cm



434986H

ivory
strukturiert, matt
structuré, mat
structured, matt

434987H

concrete
strukturiert, matt
structuré, mat
structured, matt

434988H

sepia
strukturiert, matt
structuré, mat
structured, mat

434989H

anthracite
strukturiert, matt
structuré, mat
structured, mat

* Hohes Gewicht! Karton bitte nur zu Zweit transportieren.
* Poids élevé ; a transporter par deux personnes seulement.
* High weight only to carry with two persons.



Lässig und modern

Bei Timeless verschmelzen Grafik und Relief von vertrautem Schiefer zu einer modernen Oberfläche, die Zeitlosigkeit, Eleganz und Coolness transportiert. So passt sich die Serie in verschiedene Stilwelten harmonisch ein: von lässig, modern bis gemütlich. Highlight der Serie ist die reliefierte Dekorfliese Arita, entwickelt in der Zusammenarbeit mit dem Designer Fritz Rossmann. In Anlehnung an seine bekannten Porzellan-gefäße verführt Arita durch ihre wechselnd rhythmischen Kerbungen zum Berühren und Fühlen – und Zeitlosigkeit trifft haptische Erfahrung.

Pour un style casual, moderne ou maison de campagne

La série Timeless utilise les reliefs de l'ardoise classique pour créer une surface moderne, qui véhicule un caractère intemporel, élégant et cool. La série convient ainsi idéalement à différents univers, qu'ils soient chaleureux, modernes ou plutôt décontractés. La pièce maîtresse de la série est le carreau de décoration à relief Arita, développé en collaboration avec le designer Fritz Rossmann. Arita s'inspire des célèbres céramiques japonaises. Le rythme de ces rainures changeantes invite au toucher. La rencontre d'un style intemporel et d'une expérience tactile unique.

For casual, modern or country living

The look and feel of familiar slate in the Timeless range merge to form a modern surface which exudes timelessness, elegance and coolness. Enabling the range to adapt harmoniously to various style collections: whether casual, modern or cosy. One highlight of the range is represented by the structured Arita decorative element, developed in collaboration with the designer Fritz Rossmann. In conformity with his popular porcelain bowls, Arita entices you to touch and feel its changing rhythmic notching – where timelessness meets a haptic experience.





Art.	Nennmaß cote nominale nominal size cm	Herstellmaß cote de fabrication production size mm	m ²	Paket carton box	Palette palette pallet	Beanspr.-Gruppe groupe d'emploi wear resist. group	Norm Norme Standard	Trittsicherheit antidérapance non-slip	Preisgruppe groupe de prix price category
283172H	30 x 60	297 x 597 x 9	5,556 St pc	9 St pc	77,754 m ²		BIII GL		C116 (m ²)
283173H			14,946 kg	1,620 m ² 24,210 kg	1.162,080 kg		BIII GL		C125 (m ²)

Wandfliese | carreau de mur | wall tile

Steingut glasiert | faïence émaillée | earthenware glazed

30 x 60 cm

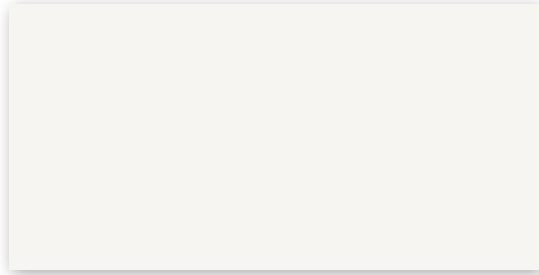

283172H

natural white

strukturiert, seidenmatt | structuré, satiné | structured, silky-matt



V1

Dekorationselemente | éléments décoratifs | decoration elements

Dekorfliese Arita | carreau décoratif Arita | decorative element Arita

Steingut glasiert | faïence émaillée | earthenware glazed

30 x 60 cm



283173H

natural white

strukturiert, seidenmatt | structuré, satiné | structured, silky-matt



Abgabe der Dekorationselemente ausschließlich in vollen Kartons.
 Éléments décoratifs uniquement livrables en cartons entiers.
 Decoration elements only available in full boxes.

Art.	Nennmaß cote nominale nominal size cm	Herstellmaß cote de fabrication production size mm	m	Paket carton box	Palette palette pallet	Beanspr.-Gruppe groupe d'emploi wear resist. group	Norm Norme Standard	Trittsicherheit antidérapance non-slip	Preisgruppe groupe de prix price category
283174H							Bla UGL	R10/A+B	C510 (St pc)
283175H	30 x 30	297 x 297 x 10,5	3,333 St pc	2 St pc			Bla UGL	R10/A+B	C510 (St pc)
283176H			6,933 kg	0,600 m	4,160 kg		Bla UGL	R10/A+B	C510 (St pc)

Dekorationselemente | éléments décoratifs | decoration elements

Mosaikmatte Trio | mosaïque Trio | mosaic sheet Trio

Feinsteinzeugfliesen unglasiert | grès cérame fin vitrifié non-émaillés | porcelain stoneware tiles unglazed

30 x 30 cm



283174H

sand
strukturiert, matt
structuré, mat
structured, matt



283175H

pebble grey
strukturiert, matt
structuré, mat
structured, matt



283176H

black
strukturiert, matt
structuré, mat
structured, matt



Mosaik, Verklebung
rückseitig auf
Glasfasernetz, Bogen:
297 x 297 mm

Mosaïque, collée sur
trame en fibre de verre à
l'envers, Feuille :
297 x 297 mm

Mosaic, glass fibre net
on reverse side, Sheet:
297 x 297 mm

Art.	Nennmaß cote nominale nominal size cm	Herstellmaß cote de fabrication production size mm	m ²	Paket carton box	Palette palette pallet	Beanspr.-Gruppe groupe d'emploi wear resist. group	Norme Standard	Trittsicherheit antidérapance non-slip	Preisgruppe groupe de prix price category
432086H							Bla UGL	R10/A+B	C146 (m ²)
432087H	30 x 60	297 x 597 x 10,5	5,556 St pc	6 St pc	43,197 m ²		Bla UGL	R10/A+B	C146 (m ²)
432088H			23,224 kg	1,080 m ² 25,080 kg	1.003,200 kg		Bla UGL	R10/A+B	C146 (m ²)
432089H							Bla UGL	R10/A+B	C155 (m ²)
432090H	60 x 60	597 x 597 x 10,5	2,778 St pc	3 St pc	38,877 m ²		Bla UGL	R10/A+B	C155 (m ²)
432091H			23,769 kg	1,080 m ² 25,668 kg	924,048 kg		Bla UGL	R10/A+B	C155 (m ²)



sand



pebble grey



black



Bodenfliese | carreau de sol | floor tile

Feinsteinzeugfliesen unglasiert | grès cérame fin vitrifié non-émaillés | porcelain stoneware tiles unglazed

30 x 60 cm



432086H

sand
strukturiert, matt
structuré, mat
structured, matt



432087H

pebble grey
strukturiert, matt
structuré, mat
structured, matt

432088H

black
strukturiert, matt
structuré, mat
structured, matt

60 x 60 cm



432089H

sand
strukturiert, matt
structuré, mat
structured, matt



432090H

pebble grey
strukturiert, matt
structuré, mat
structured, matt

432091H

black
strukturiert, matt
structuré, mat
structured, matt

Art.	Nennmaß cote nominale nominal size cm	Herstellmaß cote de fabrication production size mm	m ² /m	Paket carton box	Palette palette pallet	Beanspr.-Gruppe groupe d'emploi wear resist. group	Norm Norme Standard	Trittsicherheit antidérapance non-slip	Preisgruppe groupe de prix price category
432092H							Alb UGL	R10/A+B	C200 (m ²)
432093H	60 x 120	597 x 1197 x 10,5	1,388 St pc / m ²	2 St pc	30,259 m ²		Alb UGL	R10/A+B	C200 (m ²)
432094H			23,804 kg	1,441 m ²	34,300 kg		Alb UGL	R10/A+B	C200 (m ²)
432095H							Bla UGL		C440 (St pc)
432096H	7 x 60	70 x 597 x 10,5	1,667 St pc / m	15 St pc			Bla UGL		C440 (St pc)
432097H			1,584 kg	8,998 m	14,250 kg		Bla UGL		C440 (St pc)

Bodenfliese | carreau de sol | floor tile

Feinsteinzeugfliesen unglasiert | grès cérame fin vitrifié non-émaillés | porcelain stoneware tiles unglazed

60 x 120 cm



432092H

sand
strukturiert, matt
structuré, mat
structured, matt

432093H

pebble grey
strukturiert, matt
structuré, mat
structured, matt

432094H

black
strukturiert, matt
structuré, mat
structured, matt

Sockel, gerundet | plinthe, arrondie | skirting, rounded

Feinsteinzeugfliesen unglasiert | grès cérame fin vitrifié non-émaillés | porcelain stoneware tiles unglazed

7 x 60 cm

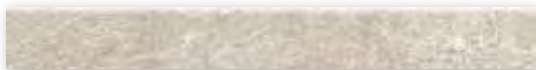

432095H

sand
strukturiert, matt
structuré, mat
structured, matt

432096H

pebble grey
strukturiert, matt
structuré, mat
structured, matt

432097H

black
strukturiert, matt
structuré, mat
structured, matt



Studioaufnahme · photo prise en studio · studio photo / Architekt · architecte · architect: VSBL, Belgrad, Serbien · Belgrade, Serbie · Belgrade, Serbia /
Serie · série · series: Urban Cotto / Photo: Jochen Stüber



Natürlichkeit trifft City

Urban Cotto bringt natürliche Eleganz in den gesamten Wohnbereich. Die Protecta-vergütete Feinsteinzeugserie überzeugt durch ihr klares Konzept: ein Format in 60 x 60 cm, in klassischem Terra, Beige, Braun oder Grau und mit Trittsicherheitsstufe R10. Für eine kompromisslose Gestaltung nach dem Vorbild traditionsreicher Cotto-Fliesen.

Le naturel à la rencontre de l'urbain

Urban Cotto apporte aux espaces intérieurs, grâce aux variantes conçues à cet effet, une touche d'élégance naturelle. La gamme, des carreaux en grés cérame à revêtement Protecta, séduit par la clarté de son concept : un format de 60 x 60 cm pour des carreaux antidérapants R10 aux teintes classique terra, beige, brun et gris. Pour une décoration sans compromis sur le modèle des carreaux en terre cuite, riches en tradition.

Naturalness meets the city

Urban Cotto injects natural elegance into the entire living area. The Protecta-coated porcelain stoneware series is convincing thanks to its unambiguous concept: one format in 60 x 60 cm, in classic terra, beige, brown or grey and with non-slip R10. For an uncompromising design based on traditional cotto tiles.

670 URBAN COTTO

Art.	Nennmaß cote nominale nominal size cm	Herstellmaß cote de fabrication production size mm	m ²	Paket carton box	Palette palette pallet	Beanspr.-Gruppe groupe d'emploi wear resist. group	Norm Norme Standard	Trittsicherheit antidérapance non-slip	Preisgruppe groupe de prix price category
052292							Bla UGL	R10	W117 (m ²)
052293	60 x 60	596 x 596 x 10	2,778 St pc	3 St pc	43,197 m ²		Bla UGL	R10	W117 (m ²)
052294			22,780 kg	1,080 m ² 24,600 kg	984,000 kg		Bla UGL	R10	W117 (m ²)
052295							Bla UGL	R10	W117 (m ²)



beige

V3

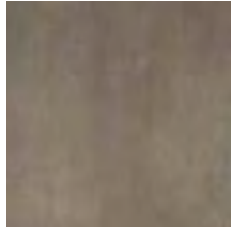

braun
brun
brown

V3

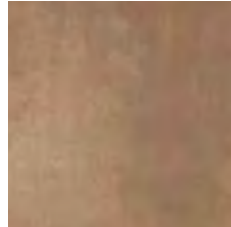

terra

V3



grau
gris
grey

V3

Bodenfliese | carreau de sol | floor tile

Feinsteinzeugfliesen unglasiert | grès cérame fin vitrifié non-émaillés | porcelain stoneware tiles unglazed

60 x 60 cm



052292

beige
eben, matt | lisse, mat | smooth, matt

052293

braun | brun | brown
eben, matt | lisse, mat | smooth, matt

052294

terra
eben, matt | lisse, mat | smooth, matt

052295

grau | gris | grey
eben, matt | lisse, mat | smooth, matt

Art.	Nennmaß cote nominale nominal size cm	Herstellmaß cote de fabrication production size mm	m	Paket carton box	Palette palette pallet	Beanspr.-Gruppe groupe d'emploi wear resist. group	Norm Norme Standard	Trittsicherheit antidérapance non-slip	Preisgruppe groupe de prix price category
052401							Bla UGL	W439 (St pc)	
052402	7 x 60	70 x 596 x 10	1,667 St pc	22 St pc			Bla UGL	W439 (St pc)	
052403			1,550 kg	13,197 m	20,460 kg		Bla UGL	W439 (St pc)	
052404							Bla UGL	W439 (St pc)	

Sockel, gerundet | plinthe, arrondie | skirting, rounded

Feinsteinzeugfliesen unglasiert | grès cérame fin vitrifié non-émaillés | porcelain stoneware tiles unglazed

7 x 60 cm

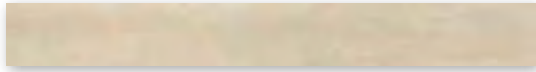

052401

beige
eben, matt | lisse, mat | smooth, matt

052402

braun | marron | brown
eben, matt | lisse, mat | smooth, matt

052403

terra
eben, matt | lisse, mat | smooth, matt

052404

grau | gris | grey
eben, matt | lisse, mat | smooth, matt





Kraftvoll, entspannt und zeitlos

Walden ist ein klassisches, naturgetreues Holzdesign gefertigt in hochwertiger Keramik. Ein natürliches Produkt, das die Beliebtheit von authentischen Holzoberflächen mit den Vorteilen keramischer Belagsmaterialien verbindet. Die 5 Farbtöne im klassischen Dielenformat 20 x 120 cm bedienen ein weites Spektrum unterschiedlichster Stilrichtungen und lassen sich je nach Wunsch harmonisch oder kontrastreich mit anderen Materialien kombinieren. Für den Outdoor Bereich stehen alle Farben im Format 40 x 120 cm zur Verfügung. Die Trittsicherheit R10/A+B sorgt für vielseitige Anwendungsmöglichkeiten im privaten und öffentlichen Interieur. Im Außenbereich bietet die Oberflächen R11/B bei jedem Wetter ein sicheres Trittgefühl.

Puissant, détendu et hors temps

Walden est un design de bois classique, réaliste, fabriqué en céramique de haute qualité. Un produit naturel qui combine la popularité des surfaces en bois authentique avec les avantages des matériaux de revêtement en céramique. Les 5 nuances de couleurs du format classique de planche de 20 x 120 cm couvrent un large éventail de styles différents et peuvent être combinées de façon harmonieuse ou contrastante avec d'autres matériaux selon les besoins. Pour la zone extérieure, toutes les couleurs sont disponibles au format de 40 x 120 cm. L'antidérapance R10/A+B assure des possibilités d'application variées dans les intérieurs privés et publics. À l'extérieur, la surface R11/B permet de marcher en toute sécurité, quelles que soient les conditions météorologiques.

Powerful, relaxed and timeless

Walden is a classic, natural wood design manufactured in high quality ceramic. It is a natural product that combines the popularity of wood surfaces with the advantages of ceramic flooring materials. The 5 color shades in the classic 20 x 120 cm plank format serve a wide range of different of different styles and can be combined harmoniously or in contrast with other materials as desired. For the outdoor area are all colors in the format 40 x 120 cm available. The slip resistance R10/A+B provides for versatile application possibilities in private and public interiors. For outdoor use, the R11/B surface offers a safe feeling of safe step feeling.

Art.	Nennmaß cote nominale nominal size cm	Herstellmaß cote de fabrication production size mm	m ² /m	Paket carton box	Palette palette pallet	Beanspr.-Gruppe groupe d'emploi wear resist. group	Norm Norme Standard	Trittsicherheit antidérapance non-slip	Preisgruppe groupe de prix price category
430685							Bla UGL	R10/A+B	C158 (m ²)
430686							Bla UGL	R10/A+B	C158 (m ²)
430687	20 x 120	197 x 1195 x 9	4,166 St pc	6 St pc	60,490 m ²		Bla UGL	R10/A+B	C158 (m ²)
430688			20,830 kg	1,440 m ² 30,000 kg	1.260,00 kg		Bla UGL	R10/A+B	C158 (m ²)
430689							Bla UGL	R10/A+B	C158 (m ²)
430690							Bla UGL		C437 (St pc)
430691							Bla UGL		C437 (St pc)
430692	6 x 60	60 x 596 x 9	1,667 St pc	27 St pc			Bla UGL		C437 (St pc)
430693			1,237 kg	16,797 m 20,034 kg			Bla UGL		C437 (St pc)
430694							Bla UGL		C437 (St pc)



sunny white



relax beige

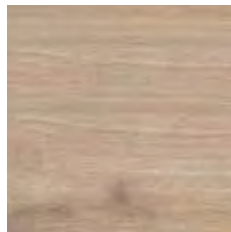

classic oak

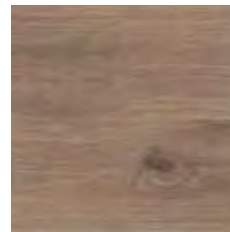

brown cherry



smokey brown



Bodenfliese | carreau de sol | floor tile*

Feinsteinzeugfliesen unglasiert | grès fin non-émaillés | porcelain stoneware tiles unglazed

20 x 120 cm



430685

sunny white
strukturiert, matt
structuré, mat
structured, matt

430686

relax beige
strukturiert, matt
structuré, mat
structured, matt

430687

classic oak
strukturiert, matt
structuré, mat
structured, matt

430688

brown cherry
strukturiert, matt
structuré, mat
structured, matt

430689

smokey brown
strukturiert, matt
structuré, mat
structured, matt

Sockel, gerundet | plinthe, arrondie | skirting, rounded

Feinsteinzeugfliesen unglasiert | grès cérame fin vitrifié non-émaillés | porcelain stoneware tiles unglazed

6 x 60 cm

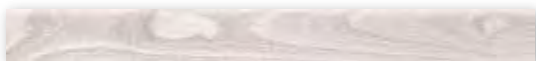

430690

sunny white
strukturiert, matt
structuré, mat
structured, matt

430691

relax beige
strukturiert, matt
structuré, mat
structured, matt

430692

classic oak
strukturiert, matt
structuré, mat
structured, matt

430693

brown cherry
strukturiert, matt
structuré, mat
structured, matt

430694

smokey brown
strukturiert, matt
structuré, mat
structured, matt

* Achtung: Sonderpalette. Keine Rücknahme, kein Umtausch.
* Attention : palette spéciale. Pas de retour, pas d'échange.
* Please note: special pallet. No return, no exchange.

Art.	Nennmaß cote nominale nominal size cm	Herstellmaß cote de fabrication production size mm	m ²	Paket carton box	Palette palette pallet	Beanspr.-Gruppe groupe d'emploi wear resist. group	Norm Norme Standard	Trittsicherheit antidérapance non-slip	Preisgruppe groupe de prix price category
430695							Bla UGL	R11/B	C239 (m ²)
430696							Bla UGL	R11/B	C239 (m ²)
430697	40 x 120	397 x 1195 x 20	2,083 St pc	2 St pc	23,047 m ²		Bla UGL	R11/B	C239 (m ²)
430698			43,535 kg	0,960 m ² 41,800 kg	1.260,00 kg		Bla UGL	R11/B	C239 (m ²)
430699							Bla UGL	R11/B	C239 (m ²)

Terrassenplatte | dalle de terrasse | patio tile*/**

Feinsteinzeugfliesen unglasiert | grès cérame fin vitrifié non-émaillés | porcelain stoneware tiles unglazed

40 x 120 cm



430695

sunny white
strukturiert, matt
structuré, mat
structured, matt

430696

relax beige
strukturiert, matt
structuré, mat
structured, matt

430697

classic oak
strukturiert, matt
structuré, mat
structured, matt

430698

brown cherry
strukturiert, matt
structuré, mat
structured, matt

430699

smokey brown
strukturiert, matt
structuré, mat
structured, matt

* Achtung: Sonderpalette. Keine Rücknahme, kein Umtausch.
* Attention : palette spéciale. Pas de retour, pas d'échange.
* Please note: special pallet. No return, no exchange.

** Hohes Gewicht! Karton bitte nur zu Zweit transportieren.
** Poids élevé ; a transporter par deux personnes seulement.
** High weight only to carry with two persons.





Contents

• Article numbers	678
• Index according to models	692
• Model numbers	694
• Classification accord. to NCS/RAL / Lightness values	696
• Luminance contrast	698
Technical information	701
World-wide distribution network	720
Comments	723

Article No.	Page(s)	Article No.	Page(s)	Article No.	Page(s)	Article No.	Page(s)	Article No.	Page(s)	Article No.	Page(s)
0002	550	052243	316	113-1037H	252	116-1015H	250	120-1116H	250	140-1025H	252
010S-1010	224	052244	316	113-1038H	252	116-1016H	250	120-1117H	250	140-1026H	252
010S-1630	224	052245	316	113-1039H	252	116-1017H	252	120-1118H	250	140-1027H	252
010S-4822	225	052246	316	113-1040H	252	116-1018H	252	120-1119H	250	140-1028H	252
010S-9066	225	052247	316	113-1111H	250	116-1019H	252	120-1120H	250	140-1029H	252
010S-9330	226	052248	316	113-1112H	250	116-1020H	252	120-1121H	250	140-1030H	252
010S-9335	226	052249	316	113-1113H	250	116-1021H	252	130-1001H	250	140-1031H	252
010S-9337	226	052265	316	113-1114H	250	116-1022H	252	130-1002H	250	140-1032H	252
010S-9338	226	052266	316	113-1115H	250	116-1023H	252	130-1003H	250	140-1033H	252
010S-9570	225	052267	316	113-1116H	250	116-1024H	252	130-1004H	250	140-1034H	252
010S-9573	225	052268	316	113-1117H	250	116-1025H	252	130-1005H	250	140-1035H	252
010S-9574	225	052269	316	113-1118H	250	116-1026H	252	130-1006H	250	140-1036H	252
052016	328	052292	670	113-1119H	250	116-1027H	252	130-1007H	250	140-1037H	252
052017	328	052293	670	113-1120H	250	116-1028H	252	130-1008H	250	140-1038H	252
052018	328	052294	670	113-1121H	250	116-1029H	252	130-1009H	250	140-1039H	252
052019	328	052295	670	113063	93, 482	116-1030H	252	130-1010H	250	140-1040H	252
052020	328	052401	671	115-1001H	250	116-1031H	252	130-1011H	250	140-1111H	250
052021	328	052402	671	115-1002H	250	116-1032H	252	130-1012H	250	140-1112H	250
052022	328	052403	671	115-1003H	250	116-1033H	252	130-1013H	250	140-1113H	250
052023	328	052404	671	115-1004H	250	116-1034H	252	130-1014H	250	140-1114H	250
052024	328	052461	328	115-1005H	250	116-1035H	252	130-1015H	250	140-1115H	250
052025	328	052462	328	115-1006H	250	116-1036H	252	130-1016H	250	140-1116H	250
052026	328	052463	328	115-1007H	250	116-1037H	252	130-1017H	252	140-1117H	250
052027	328	052464	328	115-1008H	250	116-1038H	252	130-1018H	252	140-1118H	250
052032	328	052477	328	115-1009H	250	116-1039H	252	130-1019H	252	140-1119H	250
052033	328	052478	328	115-1010H	250	116-1040H	252	130-1020H	252	140-1120H	250
052034	328	052479	328	115-1011H	250	116-1111H	250	130-1021H	252	140-1121H	250
052035	328	052480	328	115-1012H	250	116-1112H	250	130-1022H	252	144-12020	123, 346
052036	328	070S-1010	224	115-1013H	250	116-1113H	250	130-1023H	252	144-12050	123, 346
052036-53510	453	070S-1630	224	115-1014H	250	116-1114H	250	130-1024H	252	144-18120	123, 346
052036-53511	453	070S-4822	225	115-1015H	250	116-1115H	250	130-1025H	252	144-18210	123, 346
052036-53512	453	070S-9066	225	115-1016H	250	116-1116H	250	130-1026H	252	144-41550K	123, 346
052037	328	070S-9330	226	115-1017H	252	116-1117H	250	130-1027H	252	144-42550K	123, 346
052038	328	070S-9335	226	115-1018H	252	116-1118H	250	130-1028H	252	150i-12020H	123, 346
052039	328	070S-9337	226	115-1019H	252	116-1119H	250	130-1029H	252	150i-12050H	123, 346
052044	328	070S-9338	226	115-1020H	252	116-1120H	250	130-1030H	252	150i-18120H	123, 346
052045	328	070S-9570	225	115-1021H	252	120-1001H	250	130-1031H	252	150i-18210H	123, 346
052046	328	070S-9573	225	115-1022H	252	120-1002H	250	130-1032H	252	150i-41550HK	123, 346
052047	328	070S-9574	225	115-1023H	252	120-1003H	250	130-1033H	252	150i-42550HK	123, 346
052048	328	101630-6635	113	115-1024H	252	120-1004H	250	130-1034H	252	151i-12020H	123, 346
052049	328	101630-6636	113	115-1025H	252	120-1005H	250	130-1035H	252	151i-12050H	123, 346
052050	328	103197-6635	113	115-1026H	252	120-1006H	250	130-1036H	252	151i-18120H	123, 346
052051	328	103197-6636	113	115-1027H	252	120-1007H	250	130-1037H	252	151i-18210H	123, 346
052052	328	111052	93, 482	115-1028H	252	120-1008H	250	130-1038H	252	151i-41550HK	123, 346
052053	328	112000	93, 482	115-1029H	252	120-1009H	250	130-1039H	252	151i-42550HK	123, 346
052054	328	113-1001H	250	115-1030H	252	120-1010H	250	130-1040H	252	152i-12020H	123, 346
052055	328	113-1002H	250	115-1031H	252	120-1011H	250	130-1111H	250	152i-12050H	123, 346
052068	329	113-1003H	250	115-1032H	252	120-1012H	250	130-1112H	250	152i-18120H	123, 346
052069	329	113-1004H	250	115-1033H	252	120-1013H	250	130-1113H	250	152i-18210H	123, 346
052070	329	113-1005H	250	115-1034H	252	120-1014H	250	130-1114H	250	152i-41550HK	123, 346
052071	329	113-1006H	250	115-1035H	252	120-1015H	250	130-1115H	250	152i-42550HK	123, 346
052072	329	113-1007H	250	115-1036H	252	120-1016H	250	130-1116H	250	153i-12020H	123, 346
052073	329	113-1008H	250	115-1037H	252	120-1017H	252	130-1117H	250	153i-12050H	123, 346
052074	329	113-1009H	250	115-1038H	252	120-1018H	252	130-1118H	250	153i-18120H	123, 346
052075	329	113-1010H	250	115-1039H	252	120-1019H	252	130-1119H	250	153i-18210H	123, 346
052085	329	113-1011H	250	115-1040H	252	120-1020H	252	130-1120H	250	153i-41550HK	123, 346
052086	329	113-1012H	250	115-1111H	250	120-1021H	252	130-1121H	250	153i-42550HK	123, 346
052087	329	113-1013H	250	115-1112H	250	120-1022H	252	140-1001H	250	154i-12020H	123, 346
052088	329	113-1014H	250	115-1113H	250	120-1023H	252	140-1002H	250	154i-12050H	123, 346
052089	328	113-1015H	250	115-1114H	250	120-1024H	252	140-1003H	250	154i-18120H	123, 346
052090	328	113-1016H	250	115-1115H	250	120-1025H	252	140-1004H	250	154i-18210H	123, 346
052091	328	113-1017H	252	115-1116H	250	120-1026H	252	140-1005H	250	154i-41550HK	123, 346
052092	328	113-1018H	252	115-1117H	250	120-1027H	252	140-1006H	250	154i-42550HK	123, 346
052225	316	113-1019H	252	115-1118H	250	120-1028H	252	140-1007H	250	160-1001H	250
052226	316	113-1020H	252	115-1119H	250	120-1029H	252	140-1008H	250	160-1002H	250
052227	316	113-1021H	252	115-1121H	250	120-1030H	252	140-1009H	250	160-1003H	250
052228	316	113-1022H	252	115100	93, 482	120-1031H	252	140-1010H	250	160-1004H	250
052229	316	113-1023H	252	116-1001H	250	120-1032H	252	140-1011H	250	160-1005H	250
052230	316	113-1024H	252	116-1002H	250	120-1033H	252	140-1012H	250	160-1006H	250
052231	316	113-1025H	252	116-1003H	250	120-1034H	252	140-1013H	250	160-1007H	250
052232	316	113-1026H	252	116-1004H	250	120-1035H	252	140-1014H	250	160-1008H	250
052233	316	113-1027H	252	116-1005H	250	120-1036H	252	140-1015H	250	160-1009H	250
052234	316	113-1028H	252	116-1006H	250	120-1037H	252	140-1016H	250	160-1010H	250
052235	316	113-1029H	252	116-1007H	250	120-1038H	252	140-1017H	252	160-1011H	250
052236	316	113-1030H	252	116-1008H	250	120-1039H	252	140-1018H	252	160-1012H	250
052237	316	113-1031H	252	116-1009H	250	120-1040H	252	140-1019H	252	160-1013H	250
052238	316	113-1032H	252	116-1010H	250	120-1111H	250	140-1020H	252	160-1014H	250
052239	316	113-1033H	252	116-1011H	250	120-1112H	250	140-1021H	252	160-1015H	250
052240	316	113-1034H	252	116-1012H	250	120-1113H	250	140-1022H	252	160-1016H	250
052241	316	113-1035H	252	116-1013H	250	120-1114H	250	140-1023H	252	160-1017H	252
052242	316	113-1036H	252	116-1014H	250	120-1115H	250	140-1024H	252	160-1018H	252

Article-No.	Page(s)	Article-No.	Page(s)	Article-No.	Page(s)	Article-No.	Page(s)	Article-No.	Page(s)	Article-No.	Page(s)
160-1019H	252	19031-2320	153	220-1032H	253	240-1119H	251	281730	495	323332H	545
160-1020H	252	19031-9215	153	220-1033H	253	240-1120H	251	281731	495	323395H	580
160-1021H	252	19032-2290	153	220-1034H	253	240-1121H	251	281732	495	323396H	580
160-1022H	252	19032-2320	153	220-1035H	253	2401RH-K100-21	161	281733	495	323397H	581
160-1023H	252	19032-9215	153	220-1036H	253	2452	193	281757H	168	323437H	462
160-1024H	252	19033-2290	153	220-1037H	253	2455	193	281758H	168	323438H	462
160-1025H	252	19033-2320	153	220-1038H	253	260-1001H	251	281759H	168	3251H	544
160-1026H	252	19033-9215	153	220-1039H	253	260-1002H	251	282115R-02	94, 485	3252H	544
160-1027H	252	203225H	474	220-1040H	253	260-1003H	251	282116R-02	94, 485	3258H	544
160-1028H	252	203226H	474	220-1111H	251	260-1004H	251	282730H	520	3303H	542
160-1029H	252	203229H	475	220-1112H	251	260-1005H	251	282731	521	3304H	542
160-1030H	252	203232H	60	220-1113H	251	260-1006H	251	282733	521	3305H	542
160-1031H	252	203233H	60	220-1114H	251	260-1007H	251	282734	521	3306	542
160-1032H	252	203234H	60	220-1115H	251	260-1008H	251	282743H	502	3314H	543
160-1033H	252	203264	94, 485	220-1116H	251	260-1009H	251	282745H	502	3353H	544
160-1034H	252	203265	94, 485	220-1117H	251	260-1010H	251	282746	503	3354H	544
160-1035H	252	203266H	95	220-1118H	251	260-1011H	251	282748	503	340-34126	441
160-1036H	252	203267H	95	220-1119H	251	260-1012H	251	282749H	502	340-34306	441
160-1037H	252	203331H	545	220-1120H	251	260-1013H	251	282751H	502	340-34307	441
160-1038H	252	203333H	475	220-1121H	251	260-1014H	251	282813H	565	340-34308	441
160-1039H	252	203392H	580	2203-B600HK	205	260-1015H	251	282814H	565	340-34309	441
160-1040H	252	203393H	580	2204-B600HK	205	260-1016H	251	282815H	565	340-37120	429
160-1111H	250	203394H	581	2205-B600HK	205	260-1017H	253	282817H	565	340-37121	429
160-1112H	250	203408	620	2206-B600HK	205	260-1018H	253	282820H	565	340-37122	429
160-1113H	250	203409	620	2207-B600HK	205	260-1019H	253	282823H	565	340-37125	430
160-1114H	250	203410	620	2208-B600HK	205	260-1020H	253	282824	567	340-37126	430
160-1115H	250	203411	620	231032	94, 484	260-1021H	253	282826	567	340-37127	430
160-1116H	250	203412H	618	231034	94, 484	260-1022H	253	282887R	95	340-37180	429
160-1117H	250	203413H	619	23330H	545	260-1023H	253	282888R	95	340-37182	429
160-1118H	250	203431H	654	239995	94, 484	260-1024H	253	282901	592	340-37183	430
160-1119H	250	203432H	655	239996	94, 484	260-1025H	253	282902	592	340-37185	430
160-1120H	250	203433H	654	239997	94, 484	260-1026H	253	282903	592	340-37188	429
160-1121H	250	203434H	655	239998	94, 484	260-1027H	253	283005	588	340-37189	430
177	456	203435H	462	240-1001H	251	260-1028H	253	283007	589	340-53150	378
178	456	203436H	462	240-1002H	251	260-1029H	253	283008	589	340-53151	378
178-S	456	203439	463	240-1003H	251	260-1030H	253	283047H	602	340-53159	378
179	456	203440	463	240-1004H	251	260-1031H	253	283048H	603	340-55720	372
179-S	456	203441	463	240-1005H	251	260-1032H	253	283049H	603	340-55722	372
173339	93, 482	203442	463	240-1006H	251	260-1033H	253	283073H	566	340-55725	372
173340	93, 482	203443	463	240-1007H	251	260-1034H	253	283074H	566	340-55729	372
173368	93, 482	203444	94, 485	240-1008H	251	260-1035H	253	283075H	566	340-55730	371
173369	93, 482	203445	94, 485	240-1009H	251	260-1036H	253	283076H	566	340-55732	371
182	456	212120	282	240-1010H	251	260-1037H	253	283102HR	512	340-55735	371
182105H	564	212121	282	240-1011H	251	260-1038H	253	283103HR	513	340-55736	371
182106H	564	212122	282	240-1012H	251	260-1039H	253	283106H	556	340-55737	371
182125	567	212123	282	240-1013H	251	260-1040H	253	283107H	556	340-55738	371
182126	567	212124	282	240-1014H	251	260-1111H	251	283110H	558	340-55740	373
182127	567	212142	282	240-1015H	251	260-1112H	251	283111H	558	340-55742	373
182763	93, 483	213341	93, 482	240-1016H	251	260-1113H	251	283112H	558	340-55745	373
182764	93, 483	213342	93, 482	240-1017H	253	260-1114H	251	283113H	604	340-55749	373
182818H	564	220-1001H	251	240-1018H	253	260-1115H	251	283114H	604	340-55760	372
182821H	564	220-1002H	251	240-1019H	253	260-1116H	251	283126HR	512	340-55762	372
182825	567	220-1003H	251	240-1020H	253	260-1117H	251	283172H	664	340-55765	372
182827	567	220-1004H	251	240-1021H	253	260-1118H	251	283173H	664	340-55766	372
183343	93, 483	220-1005H	251	240-1022H	253	260-1119H	251	283174H	665	340-55770	372
183344	93, 483	220-1006H	251	240-1023H	253	260-1120H	251	283175H	665	340-55775	372
19020-2290	153	220-1007H	251	240-1024H	253	260-1121H	251	283176H	665	340-55820	377
19020-2320	153	220-1008H	251	240-1025H	253	280345	506	283345	94, 485	340-55821	377
19020-9215	153	220-1009H	251	240-1026H	253	280349-73	506	283346	94, 485	340-55822	377
19021-2290	153	220-1010H	251	240-1027H	253	280350-73	508	289358	95	340-55825	377
19021-2320	153	220-1011H	251	240-1028H	253	280351-73	507	289359	95	340-55826	377
19021-9215	153	220-1012H	251	240-1029H	253	280354	506	289360	95	340-55830	377
19022-2290	153	220-1013H	251	240-1030H	253	280360	506	289361	95	340-55831	377
19022-2320	153	220-1014H	251	240-1031H	253	280361	508	3201H	543	340-55832	377
19022-9215	153	220-1015H	251	240-1032H	253	280362	507	3202H	543	340-55835	377
19024-2290	153	220-1016H	251	240-1033H	253	280374	94, 485	3203H	543	340-55836	377
19024-2320	153	220-1017H	253	240-1034H	253	280375	94, 485	3206H	543	340-55840	378
19024-9215	153	220-1018H	253	240-1035H	253	280718	94, 485	3221H	542	340-55841	378
19025-2290	153	220-1019H	253	240-1036H	253	280719	94, 485	3222H	542	340-55845	378
19025-2320	153	220-1020H	253	240-1037H	253	280871	94, 485	3227	542	340-59420	371
19025-9215	153	220-1021H	253	240-1038H	253	280872	94, 485	3228H	542	340-59422	371
19026-2290	153	220-1022H	253	240-1039H	253	280874H	520	323227H	474	340-59425	371
19026-2320	153	220-1023H	253	240-1040H	253	281140H	520	323228H	474	340-59426	371
19026-9215	153	220-1024H	253	240-1111H	251	281476	614	323230H	475	340-59427	371
19027-2290	153	220-1025H	253	240-1112H	251	281477	614	323235H	60	340-59428	371
19027-2320	153	220-1026H	253	240-1113H	251	281479	614	323236H	60	340-59620	437
19027-9215	153	220-1027H	253	240-1114H	251	281480	614	323237H	60	340-59627	437
19030-2290	153	220-1028H	253	240-1115H	251	281726	494	323260	94, 486	340-59628	437
19030-2320	153	220-1029H	253	240-1116H	251	281727	494	323261	94, 486	340-59629	437
19030-9215	153	220-1030H	253	240-1117H	251	281728	495	323262H	95	340-59630	437
19031-2290	153	220-1031H	253	240-1118H	251	281729	495	323263H	95	340-59637	437

Article No.	Page(s)	Article No.	Page(s)	Article No.	Page(s)	Article No.	Page(s)	Article No.	Page(s)	Article No.	Page(s)
340-59638	437	360-1039H	253	393104H	512	41221H	193	41929H	43	430223H	60
340-59639	437	360-1040H	253	393105H	514	41222H	193	41930H	43	430224H	60
340i-32020H	127, 349	360-1111H	251	393115H	605	41223H	193	42000H	531	430225H	60
340i-32025H	129, 351	360-1112H	251	393116H	605	41300H	194	42001H	531	430226H	60
340i-32027H	129, 351	360-1113H	251	393127H	512	41301H	194	42002H	531	430227H	60
340i-32050H	127, 349	360-1114H	251	40000H	213	41302H	194	42010H	531	430228H	60
340i-32055H	129, 351	360-1115H	251	40001H	213	41303H	194	42020H	531	430229H	60
340i-32057H	129, 351	360-1116H	251	40002H	213	41304H	194	42100H	534	430230H	60
340i-34070H	441	360-1117H	251	40003H	213	41305H	194	42101H	534	430231H	60
340i-34120H	441	360-1118H	251	40004H	213	41306H	194	42102H	534	430232H	60
340i-34125H	441	360-1119H	251	40005H	213	41307H	194	42103H	534	430233H	60
340i-34127H	441	360-1120H	251	40006H	213	41308H	194	42120H	532	430234H	60
340i-34128H	441	360-1121H	251	40007H	213	41309H	194	42121H	532	430235H	60
340i-34146H	435	363335	94, 486	40008H	213	41310H	194	42130H	533	430236H	60
340i-34147H	435	363336	94, 486	40009H	213	41311H	194	42200H-73	89	430237H	60
340i-34148H	435	363337H	95	40010H	213	41312H	194	42201H-73	89	430238H	60
340i-34149H	435	363338H	95	40011H	213	41313H	194	42202H-73	89	430239H	60
340i-34156H	435	363347H	596	40012H	213	41314H	194	42203H-73	89	430240H	60
340i-34157H	435	363348H	596	40013H	213	41315H	194	42204H-73	89	430241H	60
340i-34158H	435	363349H	597	40014	213	41316H	194	42400H	530	430242H	60
340i-34159H	435	363350H	598	40020H	213	41317H	194	42401H	530	430243H	60
340i-38110H	127, 349	363351H	596	40021H	213	41318H	194	42402H	530	430244H	61
340i-38115H	129, 351	363352H	654	40022H	213	41319H	194	42500H	530	430245H	61
340i-38116H	129, 351	363353H	654	40023H	213	41320H	194	42501H	530	430246H	61
340i-38117H	129, 351	363354H	655	40024H	213	41321H	194	430064H	65	430249H	61
340i-38118H	129, 351	363355H	655	40025H	213	41322H	194	430065H	65	430250H	61
3500H	549	363356	656	40026H	213	41323H	194	430066H	65	430253H	61
3501H	549	363357	656	40027H	213	41400H-73	194	430067H	65	430256H	61
3503H	549	363358	656	40028H	213	41401H-73	194	430068H	65	430257H	61
3506H	549	363359	656	40029H	213	41402H-73	194	430069H	65	430258H	61
3507H	549	363360H	556	40030H	213	41403H-73	194	430070H	65	430261H	61
3508H	549	363361H	556	40031H	213	41404H-73	194	430071H	65	430262H	61
3509H	549	363362	557	40032H	213	41405H-73	194	430072H	65	430265H	61
3540H	548	363363	557	40033H	213	41406H	194	430073H	65	430268H	61
3541H	548	363364	557	40034	213	41407H	194	430074H	65	430269H	61
3546H	548	363365	557	40040H	214	41408H	194	430075H	65	430270H	61
3547H	548	363366H	558	40041H	214	41409H	194	430080H	67	430271H	61
3548H	548	363367H	558	40042H	214	41410H	194	430081H	67	430272H	61
3549H	548	363414H	618	40044H	214	41411H	194	430082H	67	430273H	61
3555-1110	161	363415H	619	40047H	214	41412H	194	430083H	67	430274H	61
3555-4000	161	363428H	490	40048H	214	41413H	194	430084H	67	430275H	61
3555-4003	161	363429H	490	40050H	213	41414H	194	430085H	67	430276H	61
3555-4004	161	363430H	491	40051H	213	41415H	194	430086H	67	430277H	61
360-1001H	251	381467	95	40052H	213	41420H	194	430087H	67	430278H	61
360-1002H	251	381468	95	40053H	213	41421H	194	430088H	67	430279H	61
360-1003H	251	381474	93, 483	40054H	213	41422H	194	430089H	67	430280H	61
360-1004H	251	381475	93, 483	40055H	213	41423H	194	430090H	67	430281H	61
360-1005H	251	381799H	322	40056H	213	41424H	194	430091H	67	430282H	61
360-1006H	251	382819H	564	40057H	213	41425H	194	430093H	70	430283H	61
360-1007H	251	382822H	564	40071H	214	41426H	194	430093H-RE	71	430284H	61
360-1008H	251	391572	95	410-2008	276	41427H	194	430093H-RER	71	430285H	61
360-1009H	251	391573	95	410-2023	276	41428H	194	430093H-RERZ	71	430286H	61
360-1010H	251	391589	94, 486	410-2038	276	41429H	194	430093H-RZ	71	430287H	61
360-1011H	251	391590	94, 486	410-2039	276	41430H	194	430093H-SE	71	430288H	61
360-1012H	251	392720	494	410-2040	276	41431H	194	430093H-SZ	71	430289H	61
360-1013H	251	392721	494	410-2041	276	41432H	194	430094H	70	430290H	61
360-1014H	251	392723	496	410-2042	276	41433H	194	430095H	70	430291H	61
360-1015H	251	392724	496	410-2043	276	41434H	194	430096H	70	430292H	62
360-1016H	251	392725	496	410-2111	276	41435H	194	430097H	70	430293H	62
360-1017H	253	392726	496	410-2113	276	41450H	194	430098H	70	430294H	62
360-1018H	253	392727	496	41200H	192	41451H	194	430115H	70	430295H	62
360-1019H	253	392728	496	41201H	192	41452H	194	430116H	70	430296H	62
360-1020H	253	392735H	520	41202H	192	41453H	194	430117H	70	430297H	62
360-1021H	253	392736H	520	41203H	192	41454H	194	430185H	60	430298H	62
360-1022H	253	392738H	520	41204H	192	41455H	194	430186H	60	430299H	62
360-1023H	253	392739H	522	41205H	192	41456H	194	430187H	60	430300H	62
360-1024H	253	392740H	522	41206H	192	41457H	194	430188H	60	430301H	62
360-1025H	253	392742H	522	41207H	192	41505	193	430189H	60	430302H	62
360-1026H	253	392911H	634	41208H	192	41509	193	430190H	60	430303H	62
360-1027H	253	392912H	634	41209H	192	41510	193	430200H	63, 233	430304H	62
360-1028H	253	392913H	634	41210H	192	41513	193	430201H	63, 233	430304H-N	68
360-1029H	253	392914H	634	41211H	192	41520H	192	430202H	63, 233	430304H-R	68
360-1030H	253	392915H	635	41212H	192	41920H	43	430214H	63	430305H	62
360-1031H	253	392916H	635	41213H	192	41921H	43	430215H	63	430306H	62
360-1032H	253	392917H	635	41214H	192	41922H	43	430216H	63	430307H	62
360-1033H	253	392918	635	41215H	192	41923H	43	430217H	63	430308H	62
360-1034H	253	392919	635	41216H	193	41924H	43	430218H	63	430309H	62
360-1035H	253	393006	588	41217H	193	41925H	43	430219H	63	430310H	62
360-1036H	253	393050H	602	41218H	193	41926H	43	430220H	60	430311H	62
360-1037H	253	393051H	603	41219H	193	41927H	43	430221H	60	430312H	62
360-1038H	253	393052H	603	41220H	193	41928H	43	430222H	60	430312H-N	68

Article-No.	Page(s)	Article-No.	Page(s)	Article-No.	Page(s)	Article-No.	Page(s)	Article-No.	Page(s)	Article-No.	Page(s)
430312H-R	68	430396H	63	430467H	66	430550H	66	430678	577	430762H	82
430313H	62	430397H	63	430468H	66	430551H	66	430679	577	430763H	82
430314H	62	430398H	63	430469H	66	430552H	66	430680	577	430764H	82
430315H	62	430398H-TF	66	430470H	66	430553H	66	430681	577	430765H	82
430316H	62	430398H-TK	67	430471H	66	430554H	66	430684	233	430766H	82
430317H	62	430399H	63	430472H	66	430555H	66	430685	674	430767H	82
430318H	62	430400H	63	430473H	66	430556H	66	430686	674	430768H	82
430319H	62	430401H	63	430474H	66	430557H	66	430687	674	430769H	82
430320H	62	430402H	63	430475H	66	430558H	66	430688	674	430770H	82
430321H	62	430403H	63	430480H	64	430559H	66	430689	674	430771H	82
430322H	62	430404H	63	430481H	64	430560H	66	430690	674	430772H	82
430323H	62	430405H	63	430482H	64	430561H	66	430691	674	430773H	82
430324H	62	430406H	63	430483H	64	430562H	66	430692	674	430774H	82
430325H	62	430407H	63	430484H	64	430563H	66	430693	674	430775H	82
430326H	62	430407HDTB	311	430485H	64	430564H	64	430694	674	430776H	82
430327H	62	430407HDTL	311	430486H	64	430565H	64	430695	675	430777H	82
430328H	62	430407HDWTL	311	430487H	64	430566H	64	430696	675	430778H	82
430329H	62	430407HKSL	311	430488H	64	430567H	64	430697	675	430779H	83
430330H	62	430407HKSM	311	430489H	64	430568H	64	430698	675	430780H	83
430331H	62	430407HWTB	311	430490H	64	430569H	64	430699	675	430781H	83
430332H	62	430407HWTL	311	430491H	64	430570H	64	430701H	79	430782H	83
430333H	62	430407HWTS	311	430492H	64	430571H	64	430702H	79	430783H	83
430334H	62	430408H	63	430493H	64	430572H	64	430703H	79	430784H	83
430335H	62	430409H	63	430494H	64	430573H	64	430704H	79	430785H	83
430336H	62	430410H	63	430495H	64	430574H	64	430705H	79	430786H	83
430337H	62	430411H	63	430496H	64	430575H	64	430706H	79	430787H	83
430338H	62	430412H	63	430497H	64	430576H	63	430707H	79	430788H	83
430339H	62	430413H	63	430498H	64	430577H	63	430708H	79	430789H	83, 379
430340H	62	430414H	63	430499H	64	430578H	63	430709H	79	430790H	83, 379
430340H-TK	67	430415H	63	430500H	64	430579H	63	430710H	79	430791H	83, 379
430341H	62	430416H	63	430501H	64	430580H	63	430711H	79	430792H	83, 379
430342H	62	430417H	63	430502H	64	430581H	63	430712H	79	430793H	83, 379
430343H	62	430418H	63	430503H	64	430582H	63	430713H	79	430794H	83, 379
430344H	62	430419H	63	430504H	66	430583H	63	430714H	79	430795H	83, 379
430345H	62	430420H	63	430505H	66	430584H	63	430715H	79	430796H	83, 379
430346H	62	430421H	63	430506H	66	430585H	63	430716H	79	430797H	478
430347H	62	430422	64	430507H	66	430586H	63	430717H	81	430798H	478
430348H	62	430423	64	430508H	66	430587H	63	430718H	81	430802H	83, 379
430349H	62	430424	64	430509H	66	430635	574	430719H	81	430803H	83, 379
430350H	62	430425	64	430510H	66	430636	574	430720H	81	430804H	83, 379
430351H	62	430426	64	430511H	66	430637	574	430721H	79	430805H	83, 379
430352H	62	430427	64	430512H	66	430638	574	430722H	79	430806H	84
430353H	62	430428H	64	430513H	66	430639	574	430723H	79	430807H	84
430354H	62	430429H	64	430514H	66	430640	573	430724H	79	430808H	84
430355H	62	430430H	64	430515H	66	430641	573	430725H	79	430809H	84
430356H	62	430431H	64	430516H	67	430642	573	430726H	79	430810H	84, 445
430357H	62	430432H	64	430517H	67	430643	573	430727H	79	430811H	84, 445
430358H	62	430433H	64	430518H	67	430644	573	430728H	79	430812H	84, 445
430359H	62	430434H	64	430519H	67	430645	570	430729H	80	430813H	84, 445
430360H	62	430435H	64	430520H	67	430646	570	430730H	80	430814H	84, 445
430361H	62	430436H	64	430521H	67	430647	570	430731H	80	430815H	84, 445
430362H	62	430437H	64	430522H	67	430648	570	430732H	80	430816H	84, 445
430363H	62	430438H	64	430523H	67	430649	570	430733H	80	430817H	84, 445
430364H	62	430439H	64	430524H	67	430650	570	430734H	80	430818H	84, 445
430365H	62	430440H	64	430525H	67	430651	570	430735H	80	430819H	84, 445
430366H	62	430441H	64	430526H	67	430652	570	430736H	80	430820H	84, 445
430367H	62	430442H	64	430527H	67	430653	570	430737H	81	430821H	84, 445
430368H	62	430443H	64	430528H	67	430654	570	430738H	81	430822H	84, 445
430369H	62	430444H	64	430529H	67	430655	571	430739H	81	430823H	84, 445
430370H	62	430445H	64	430530H	67	430656	571	430740H	81	430824H	84, 445
430371H	62	430446H	64	430531H	67	430657	571	430741H	81	430825H	84, 445
430372H	62	430447H	64	430532H	67	430658	571	430742H	81	430826H	85
430373H	62	430448H	64	430533H	67	430659	571	430743H	81	430827H	85
430374H	62	430449H	64	430534H	67	430660	572	430744H	81	430828H	85
430375H	62	430450H	64	430535H	67	430661	572	430745H	80	430829H	85
430380H	63	430451H	64	430536H	67	430662	572	430746H	80	430830H	85
430381H	63	430452H	64	430537H	67	430663	572	430747H	80	430831H	85
430382H	63	430453H	64	430538H	67	430664	572	430748H	80	430832H	85
430383H	63	430454H	64	430539H	67	430665	575	430749H	80	430833H	85
430384H	63	430455H	64	430540H	66	430666	575	430750H	80	430834H	476
430385H	63	430456H	64	430540H-TF	66	430667	575	430751H	80	430835H	476
430386H	63	430457H	64	430540H-TK	67	430668	575	430752H	80	430836H	476
430387H	63	430458H	64	430541H	66	430669	575	430753H	82	430837H	476
430388H	63	430459H	64	430542H	66	430670	576	430754H	82	430838H	476
430389H	63	430460H	64	430543H	66	430671	576	430755H	82	430839H	476
430390H	63	430461H	64	430544H	66	430672	577	430756H	82	430840H	476
430391H	63	430462H	64	430545H	66	430673	577	430757H	82	430841H	476
430392H	63	430463H	64	430546H	66	430674	577	430758H	82	430842H	477
430393H	63	430464H	66	430547H	66	430675	577	430759H	82	430843H	477
430394H	63	430465H	66	430548H	66	430676	577	430760H	82	430844H	477
430395H	63	430466H	66	430549H	66	430677	577	430761H	82	430845H	477

Article No.	Page(s)	Article No.	Page(s)	Article No.	Page(s)	Article No.	Page(s)	Article No.	Page(s)	Article No.	Page(s)
430846H	478	430928	105	431117H	219	431509H	79	431622H	623	431840H	240
430847H	478	430929	105	431118H	219	431510H	79	431623H	623	431841H	240
430848H	478	430930	105	431119H	219	431511H	79	431624H	623	431842H	240
430849H	478	430931	105	431120H	219	431512H	79	431630H	657	431843H	240
430850H	478	430932	105	431121H	219	431513H	80	431631H	657	431844H	240
430851H	478	430933	105	431122H	219	431514H	80	431632H	657	431845H	240
430853	644	430934	105	431123H	219	431515H	80	431633H	657	431846H	241
430854	644	430935	105	431124H	219	431516H	80	431634H	657	431847H	241
430855	644	430936	105	431125H	219	431517H	80	431635H	657	431848H	241
430856	644	430937	105	431126H	219	431518H	80	431636H	657	431849H	241
430857	638	430938	105	431127H	219	431519H	80	431637H	657	431850H	241
430858	638	430939	105	431128H	219	431520H	80	431638H	659	431851H	241
430859	638	430940	105	431320	177	431521H	80	431639H	659	431852H	241
430860	638	430941	105	431321	177	431522H	80	431640H	659	431853H	241
430861	638	430942	105	431328H	585	431523H	81	431641H	659	431854H	241
430862	638	430943	105	431329H	585	431524H	81	431642H	659	431855H	241
430863	638	430944	105	431330H	585	431525H	81	431643H	659	431856H	241
430864	638	430945	105	431331H	585	431526H	81	431644H	659	431857H	241
430865	639	430946	106	431332H	582	431527H	81	431645H	659	431858H	241
430866	639	430947	106	431333H	582	431528H	81	431744H	239	431859H	241
430867	639	430948	106	431334H	582	431529H	81	431745H	239	431860H	241
430868	639	430949	106	431335H	582	431530H	81	431746H	239	431861H	241
430869	639	430950	106	431336H	582	431531H	81	431747H	239	431862H	241
430870	639	430951	106	431337H	582	431532H	81	431748H	239	431863H	241
430871	639	430952	106	431338H	582	431533H	82	431749H	239	431864H	242
430872	639	430953	106	431339H	582	431534H	82	431750H	240	431865H	242
430873	639	430954	106	431340H	583	431535H	82	431751H	240	431866H	242
430874	639	430955	106	431341H	583	431536H	82	431752H	240	431867H	242
430875	639	430956	106	431342H	583	431537H	82	431753H	240	431868H	242
430876	639	430957	106	431343H	583	431538H	82	431754H	241	431869H	242
430877	640	430958	106	431344	584	431539H	82	431755H	241	431873H	239
430878	640	430959	106	431345	584	431540H	82	431756H	241	431874H	239
430879	640	430960	106	431346	584	431541H	82	431757H	241	431875H	239
430880	640	430963	96	431347	584	431542H	82	431758H	241	431876H	239
430881	641	430964	96	431348H	585	431543H	82	431759H	241	431877H	239
430882	641	430965	96	431349H	585	431544H	82	431760H	241	431878	241
430883	641	430966	96	431350H	585	431545H	82	431761H	241	431879	241
430884	641	430967	96	431351H	585	431546H	83	431762H	242	431880	241
430885	641	430968	96	431380	630	431547H	83	431763H	242	431881	241
430886	641	430976	105, 233	431381	630	431548H	83	431766H	242	431882	241
430887	641	430977	105, 233	431382	630	431549H	83	431787H	242	431887H	242
430888	641	430978	105, 233	431383	628	431550H	83	431788H	241	431893H	242
430889	643	430979	105, 233	431384	628	431551H	83, 379	431789H	241	431894H	242
430890	643	430980H	80	431385	628	431552H	83, 379	431790H	241	431913	515
430891	643	430981H	80	431386	630	431553H	83, 379	431791H	241	431914	515
430892	643	430982H	80	431387	630	431554H	83, 379	431792H	241	431915	515
430893	643	430983H	80	431388	630	431555H	83, 379	431793H	241	431916	515
430894	643	430984H	81	431389	629	431556H	83, 379	431801H	239	431917	515
430895	643	430985H	81	431390	629	431557H	84	431802H	239	431918	515
430896	643	430986H	81	431391	629	431558H	84	431803H	239	431919H	516
430897	642	430987H	81	431392	629	431559H	84, 445	431804H	239	431920	516
430898	642	430988H	81	431393	629	431560H	84, 445	431805H	239	431921	516
430899	642	430989H	81	431394	629	431561H	84, 445	431806H	239	431922	516
430900	642	430990H	81	431480	470	431562H	84, 445	431807H	239	431930	559
430901	104	430991H	81	431481	470	431563H	84, 445	431808H	239	431931	559
430902	104	430992	104, 233	431482	470	431564H	84, 445	431809H	239	431932	559
430903	104	430993	104, 233	431483	470	431565H	84, 445	431810H	239	431933	559
430904	104	430994	105, 233	431484	470	431566H	84, 445	431811H	239	431934	559
430905	104	430995	105, 233	431485	464	431567H	85	431817H	239	431935	559
430906	104	430996	105, 233	431486	464	431568H	85	431818H	239	431936	559
430907	104	430997	105, 233	431487	464	431601H	624	431819H	239	431937	559
430908	104	43100H	538	431488	464	431602H	624	431820H	239	431938	560
430909	104	43101H	538	431489	464	431603H	624	431821H	239	431939	560
430910	104	431020	644	431490	465	431604H	624	431822H	239	431940	560
430911	104	431021	638	431491	465	431605H	621	431823H	239	431941	560
430912	104	431022	638	431492	465	431606H	621	431824H	239	431942	560
430913	104	431023	639	431493	465	431607H	621	431825H	239	431943	560
430914	104	431024	639	431494	465	431608H	621	431826H	239	431944	560
430915	104	431025	639	431495	469	431609H	621	431827H	239	431945	560
430916	104	431026	640	431496	469	431610H	621	431828H	239	431946	557
430917	104	431027	641	431497	469	431611H	621	431829H	240	431947	557
430918	104	431028	641	431498	469	431612H	621	431830H	240	431948	557
430919	104	431029	642	431499	469	431613H	622	431831H	240	431949	557
430920	104	431030	643	431501H	79	431614H	622	431832H	240	431950H	561
430921	104	431031	643	431502H	79	431615H	622	431833H	240	431951H	561
430922	104	431111H	219	431503H	79	431616H	622	431834H	240	431952H	561
430923	104	431112H	219	431504H	79	431617H	623	431835H	240	431953H	561
430924	104	431113H	219	431505H	79	431618H	623	431836H	240	43200H	538
430925	104	431114H	219	431506H	79	431619H	623	431837H	240	432016	168
430926	105	431115H	219	431507H	79	431620H	623	431838H	240	432017	168
430927	105	431116H	219	431508H	79	431621H	623	431839H	240	432018	168

Article-No.	Page(s)	Article-No.	Page(s)	Article-No.	Page(s)	Article-No.	Page(s)	Article-No.	Page(s)	Article-No.	Page(s)
432019	168	433675	322	433852	169	434830	469	435636H	69, 378	47079H	201
43201H	538	433677	322	433854	169	434831	466	435637H	69, 444	47250H	201
432027	170, 177	433678	323	433855	169	434832	466	435638H	69, 444	47251H	201
432028	170, 177	433679	323	433856	169	434833	466	435639H	69, 444	47252H	201
432029	170, 177	433680	323	433891	322	434834	466	435640H	69, 444	47253H	201
432030	170, 177	433681	323	433893	322	434835	466	435641H	69, 444	47254H	201
432033	170, 177	433682	323	434194	233	434850	650	435642H	69, 444	47255H	201
432034	170, 177	433684	323	434216	176	434851	650	435643H	69, 444	47256H	201
432035	170, 177	433685	323	434217	176	434852	650	435644H	69, 444	47257H	201
432036	170, 177	433686	323	434218	176	434853	650	435645H	69, 444	47258H	201
432039	170, 177	433687	323	434219	176	434854	648	435646H	69, 444	47259H	201
432040	170, 177	433688	323	434220	176	434855	648	435647H	69, 444	47275H	201
432041	170, 177	433689	323	434221	176	434856	648	435648H	69, 444	47276H	201
432042	170, 177	433691	323	434222	176	434857	648	435649H	69, 444	47277H	201
432045	170, 177	433692	497	434223	176	434858	648	435650H	69, 444	47278H	201
432046	170, 177	433693	497	434224	176	434859	648	435651H	69, 444	47279H	201
432047	170, 177	433694	497	434225	176	434860	648	435652H	69, 444	47280H	201
432048	170, 177	433695	499	434226	176	434861	648	435653H	69, 444	47281H	201
432086H	666	433696	499	434227	176	434862	649	435654H	69, 444	47282H	201
432087H	666	433697	499	434228	176	434863	649	435655H	69, 444	47283H	201
432088H	666	433701	323	434229	176	434864	649	435656H	69, 444	47284H	201
432089H	666	433702	323	434230	176	434865	649	435657H	69, 444	47650H	201
432090H	666	433703	323	434231	176	434866	649	435658H	69, 444	47651H	201
432091H	666	433704	323	434232	176	434867	649	435659H	69, 444	47652H	201
432092H	667	433705	323	434233	176	434868	649	435660H	69, 444	47653H	201
432093H	667	433707	323	434234	176	434869	649	435661H	69, 444	47654H	201
432094H	667	433715	168	434235	176	434895	467	435662H	69, 444	47655H	201
432095H	667	433716	168	434236	176	434896	467	435663H	69, 444	47656H	201
432096H	667	433725	168	434237	176	434897	467	435664H	69, 444	47657H	201
432097H	667	433730	168	434238	176	434976	176	435665H	69, 444	47658H	201
432135H	526	433731	168	434239	176	434977	176	435666H	69, 444	47659H	201
432136H	526	433732	168	434240	176	434978	176	435667H	69, 444	509-18120	99
432137H	526	433733	168	434241	176	434979	176	435668H	69, 444	531910-148	93, 482
432138H	526	433734	168	434248	177	434980	177	435669H	69, 444	531911-148	93, 482
432139H	526	433735	168	434249	177	434981	177	435670H	69, 444	532212-800	93, 482
432140H	527	433737	498	434250	177	434983H	468	435671H	69, 444	532230-800	93, 482
432141H	527	433738	498	434251	177	434984H	468	435672H	69, 444	533434-198	94, 486
432142H	527	433739	498	434252	177	434985H	468	435673H	69, 444	533436-198	94, 486
432143H	527	433756	499	434253	177	434986H	660	435674H	69, 444	538020-400	93, 483
432144H	527	433757	499	434326	176	434987H	660	435675H	69, 444	538021-400	93, 483
43225H	539	433758	499	434328	176	434988H	660	435676H	69, 444	538260-400	93, 483
43226H	539	433770	322	434330	176	434989H	660	435677H	69, 444	538261-400	93, 483
432292	233	433771	322	434332	176	435026	176	435678H	69, 444	538280-400	93, 483
432293	233	433772	322	434334	176	435027	176	435679H	69, 444	538281-400	93, 483
432294	233	433773	322	434336	176	435028	176	435680H	69, 444	552001-12020H	120, 344
432323	658	433774	322	434342	177	435029	176	435681H	69, 444	552001-12023H	121, 347
432324	658	433776	322	434344	177	435601H	69, 378	435682H	69, 444	552001-12050H	120, 344
432325	658	433778	322	434414	322	435602H	69, 378	435683H	69, 444	552001-12053H	121, 347
432326	658	433779	322	434415	322	435603H	69, 378	435684H	69, 444	552001-17112	427
432335H	660	433780	322	434416	322	435604H	69, 378	436698	322	552001-17190	427
432336H	660	433781	322	434417	322	435605H	69, 378	44400H	533	552001-17191	427
432337H	660	433782	322	434418	322	435606H	69, 378	44401H	533	552001-17193	427
432338H	660	433784	322	434432	323	435607H	69, 378	44425H	534	552001-17194	427
432805-HKS	170	433786	322	434433	323	435608H	69, 378	44447H	535	552001-17196	427
432805-IE	170	433787	322	434434	323	435609H	69, 378	44448H	535	552001-18120H	120, 344
433402	169	433788	322	434435	323	435610H	69, 378	44449H	535	552001-18123H	121, 347
433403	169	433789	322	434436	323	435611H	69, 378	45550H	157	552001-18124H	121, 347
433404	169	433793	322	434438	323	435612H	69, 378	45551H	157	552001-18190	427
433406	169	433794	322	434445	322	435613H	69, 378	45552H	157	552001-18191	427
433407	169	433795	322	434757	497	435614H	69, 378	45553H	157	552001-18192	427
433408	169	433796	322	434758	497	435615H	69, 378	45554H	157	552001-18193	427
433410	169	433797	322	434759	497	435616H	69, 378	45555H	157	552001-18194	427
433411	169	433799	322	434801	470	435617H	69, 378	45556H	157	552001-18196	427
433412	169	433802	169	434802	470	435618H	69, 378	45557H	157	552001-18210H	120, 344
433430	169	433803	169	434803	470	435619H	69, 378	45600H	157	552001-18213H	121, 347
433432	169	433804	169	434804	470	435620H	69, 378	45601H	157	552001-18214H	121, 347
433434	169	433806	169	434805	470	435621H	69, 378	45602H	157	552001-34070H	441
433436	169	433807	169	434816	464	435622H	69, 378	45603H	157	552001-34120H	441
433438	169	433808	169	434817	464	435623H	69, 378	45604H	157	552001-34125H	441
433440	168	433817	169	434818	464	435624H	69, 378	45605H	157	552001-34126H	441
433442	168	433819	169	434819	464	435625H	69, 378	45606H	157	552001-34127H	441
433660	169	433821	169	434820	464	435626H	69, 378	45607H	157	552001-34128H	441
433661	169	433823	169	434821	465	435627H	69, 378	47050H	201	552001-341550HK	257
433662	169	433841	322	434822	465	435628H	69, 378	47051H	201	552001-34170H	441
433664	169	433842	322	434823	465	435629H	69, 378	47052H	201	552001-342550HK	258
433665	169	433843	322	434824	465	435630H	69, 378	47053H	201	552001-352010HK	257
433666	169	433844	322	434825	465	435631H	69, 378	47054H	201	552001-352050HK	258
433671	322	433846	322	434826	469	435632H	69, 378	47075H	201	552001-37088	427
433672	322	433848	322	434827	469	435633H	69, 378	47076H	201	552001-37120	429
433673	322	433850	169	434828	469	435634H	69, 378	47077H	201	552001-37121	429
433674	322	433851	169	434829	469	435635H	69, 378	47078H	201	552001-37122	429

Article No.	Page(s)	Article No.	Page(s)	Article No.	Page(s)	Article No.	Page(s)	Article No.	Page(s)	Article No.	Page(s)
552001-37125	430	552001-95160	387	552002-55180	383	552003-18120H	120, 344	552011-18210H	120, 344	552019-341550HK	259
552001-37126	430	552001-95161	387	552002-55181	383	552003-18210H	120, 344	552011-341550HK	257	552019-342550HK	260
552001-37127	430	552001-95163	387	552002-55185	383	552003-341550HK	257	552011-342550HK	258	552019-352010HK	259
552001-37180	429	552001-95165	387	552002-55186	383	552003-342550HK	258	552011-352010HK	257	552019-352050HK	260
552001-37182	429	552001-95166	387	552002-55187/88	383, 387	552003-352010HK	257	552011-352050HK	258	552019-41550HK	122, 344
552001-37183	430	552001-95180	387	552002-55440	422	552003-352050HK	258	552011-41550HK	120, 344	552019-42550HK	122, 344
552001-37185	430	552001-95181	387	552002-55442	422	552003-41550HK	120, 344	552011-42550HK	120, 344	552020-12020H	122, 344
552001-37186	427	552001-95183	387	552002-55445	422	552003-42550HK	120, 344	552012-12020H	120, 344	552020-12050H	122, 344
552001-37188	429	552001-95185	387	552002-55446	422	552004-12020H	120, 344	552012-12050H	120, 344	552020-18120H	122, 344
552001-37189	430	552001-95186	387	552002-55460	423	552004-12050H	120, 344	552012-18120H	120, 344	552020-18210H	122, 344
552001-41550HK	120, 344	552001-550044	383	552002-55462	423	552004-18120H	120, 344	552012-18210H	120, 344	552020-341550HK	259
552001-42550HK	120, 344	552001-550065	395	552002-55465	423	552004-18210H	120, 344	552012-341550HK	257	552020-342550HK	260
552001-55100	395	552001-555102	395	552002-55466	423	552004-341550HK	257	552012-342550HK	258	552020-352010HK	259
552001-55101	395	552001-555142	395	552002-55561	442	552004-342550HK	258	552012-352010HK	257	552020-352050HK	260
552001-55105	395	552001-555182	383	552002-55562	442	552004-352010HK	257	552012-352050HK	258	552020-41550HK	122, 344
552001-55106	395	552001-585162	383	552002-55563	442	552004-352050HK	258	552012-41550HK	120, 344	552020-42550HK	122, 344
552001-55107/08	395	552001-585182	385	552002-55565	442	552004-41550HK	120, 344	552012-42550HK	120, 344	552021-12020H	122, 345
552001-55140	395	552001-585192	385	552002-55566	442	552004-42550HK	120, 344	552013-12020H	122, 344	552021-12050H	122, 345
552001-55141	395	552001-587162	391	552002-55567	442	552005-12020H	120, 344	552013-12050H	122, 344	552021-18120H	122, 345
552001-55143	395	552001-595162	387	552002-55800	423	552005-12050H	120, 344	552013-18120H	122, 344	552021-18210H	122, 345
552001-55145	395	552001-595182	387	552002-55802	423	552005-18120H	120, 344	552013-18210H	122, 344	552021-341550HK	259
552001-55146	395	552002-12020H	120, 344	552002-55805	423	552005-18210H	120, 344	552013-341550HK	257	552021-342550HK	260
552001-55147/48	395	552002-12023H	121, 347	552002-55806	423	552005-341550HK	257	552013-342550HK	258	552021-352010HK	259
552001-55180	383	552002-12050H	120, 344	552002-55850	403	552005-342550HK	258	552013-352010HK	257	552021-352050HK	260
552001-55181	383	552002-12053H	121, 347	552002-55852	403	552005-352010HK	257	552013-352050HK	258	552021-41550HK	122, 345
552001-55185	383	552002-17112	427	552002-55855	403	552005-352050HK	258	552013-41550HK	122, 344	552021-42550HK	122, 345
552001-55186	383	552002-17190	427	552002-55856	403	552005-41550HK	120, 344	552013-42550HK	122, 344	552022-12020H	122, 345
552001-55187/88	383, 387	552002-17191	427	552002-55857/58	403	552005-42550HK	120, 344	552014-12020H	122, 344	552022-12050H	122, 345
552001-55440	422	552002-17193	427	552002-85160	383	552006-12020H	120, 344	552014-12050H	122, 344	552022-18120H	122, 345
552001-55442	422	552002-17194	427	552002-85161	383	552006-12050H	120, 344	552014-18120H	122, 344	552022-18210H	122, 345
552001-55445	422	552002-17196	427	552002-85163	383	552006-18120H	120, 344	552014-18210H	122, 344	552022-341550HK	259
552001-55446	422	552002-18120H	120, 344	552002-85165	383	552006-18210H	120, 344	552014-341550HK	257	552022-342550HK	260
552001-55460	423	552002-18123H	121, 347	552002-85166	383	552006-341550HK	257	552014-342550HK	258	552022-352010HK	259
552001-55462	423	552002-18124H	121, 347	552002-85167/68	383, 387	552006-342550HK	258	552014-352010HK	257	552022-352050HK	260
552001-55465	423	552002-18190	427	552002-85180	385	552006-352010HK	257	552014-352050HK	258	552022-41550HK	122, 345
552001-55466	423	552002-18191	427	552002-85181	385	552006-352050HK	258	552014-41550HK	122, 344	552022-42550HK	122, 345
552001-55561	442	552002-18192	427	552002-85183	385	552006-41550HK	120, 344	552014-42550HK	122, 344	552023-12020H	122, 345
552001-55562	442	552002-18193	427	552002-85185	385	552006-42550HK	120, 344	552015-12020H	122, 344	552023-12050H	122, 345
552001-55563	442	552002-18194	427	552002-85186	385	552007-12020H	120, 344	552015-12050H	122, 344	552023-18120H	122, 345
552001-55565	442	552002-18196	427	552002-85187/88	385	552007-12050H	120, 344	552015-18120H	122, 344	552023-18210H	122, 345
552001-55566	442	552002-18210H	120, 344	552002-85190	385	552007-18120H	120, 344	552015-18210H	122, 344	552023-341550HK	259
552001-55567	442	552002-18213H	121, 347	552002-85191	385	552007-18210H	120, 344	552015-341550HK	257	552023-342550HK	260
552001-55800	423	552002-18214H	121, 347	552002-85193	385	552007-341550HK	257	552015-342550HK	258	552023-352010HK	259
552001-55802	423	552002-34070H	441	552002-85195	385	552007-342550HK	258	552015-352010HK	257	552023-352050HK	260
552001-55805	423	552002-34120H	441	552002-85196	385	552007-352010HK	257	552015-352050HK	258	552023-41550HK	122, 345
552001-55806	423	552002-34125H	441	552002-85197/98	385	552007-352050HK	258	552015-41550HK	122, 344	552023-42550HK	122, 345
552001-55850	403	552002-34126H	441	552002-86160	403	552007-41550HK	120, 344	552015-42550HK	122, 344	552024-12020H	122, 345
552001-55852	403	552002-34127H	441	552002-86161	403	552007-42550HK	120, 344	552016-12020H	122, 344	552024-12050H	122, 345
552001-55855	403	552002-34128H	441	552002-86162	403	552008-12020H	120, 344	552016-12050H	122, 344	552024-18120H	122, 345
552001-55856	403	552002-341550HK	257	552002-86163	403	552008-12050H	120, 344	552016-18120H	122, 344	552024-18210H	122, 345
552001-55857/58	403	552002-34170H	441	552002-86165	403	552008-18120H	120, 344	552016-18210H	122, 344	552024-341550HK	259
552001-85160	383	552002-342550HK	258	552002-86167/68	403	552008-18210H	120, 344	552016-341550HK	257	552024-342550HK	260
552001-85161	383	552002-352010HK	257	552002-87160	391	552008-341550HK	257	552016-342550HK	258	552024-352010HK	259
552001-85163	383	552002-352050HK	258	552002-87161	391	552008-342550HK	258	552016-352010HK	257	552024-352050HK	260
552001-85165	383	552002-37088	427	552002-87163	391	552008-352010HK	257	552016-352050HK	258	552024-41550HK	122, 345
552001-85166	383	552002-37120	429	552002-87165	391	552008-352050HK	258	552016-41550HK	122, 344	552024-42550HK	122, 345
552001-85167/68	383, 387	552002-37121	429	552002-87166	391	552008-41550HK	120, 344	552016-42550HK	122, 344	552025-12020H	122, 345
552001-85180	385	552002-37122	429	552002-87167/68	391	552008-42550HK	120, 344	552017-12020H	122, 344	552025-12050H	122, 345
552001-85181	385	552002-37125	430	552002-95160	387	552009-12020H	120, 344	552017-12050H	122, 344	552025-18120H	122, 345
552001-85183	385	552002-37126	430	552002-95161	387	552009-12050H	120, 344	552017-18120H	122, 344	552025-18210H	122, 345
552001-85185	385	552002-37127	430	552002-95163	387	552009-18120H	120, 344	552017-18210H	122, 344	552025-341550HK	259
552001-85186	385	552002-37180	429	552002-95165	387	552009-18210H	120, 344	552017-341550HK	259	552025-342550HK	260
552001-85187/88	385	552002-37182	429	552002-95166	387	552009-341550HK	257	552017-342550HK	260	552025-352010HK	259
552001-85190	385	552002-37183	430	552002-95180	387	552009-342550HK	258	552017-352010HK	259	552025-352050HK	260
552001-85191	385	552002-37185	430	552002-95181	387	552009-352010HK	257	552017-352050HK	260	552025-41550HK	122, 345
552001-85193	385	552002-37186	427	552002-95183	387	552009-352050HK	258	552017-41550HK	122, 344	552025-42550HK	122, 345
552001-85195	385	552002-37188	429	552002-95185	387	552009-41550HK	120, 344	552017-42550HK	122, 344	552026-12020H	122, 345
552001-85196	385	552002-37189	430	552002-95186	387	552009-42550HK	120, 344	552018-12020H	122, 344	552026-12050H	122, 345
552001-85197/98	385	552002-41550HK	120, 344	552002-550044	383	552010-12020H	120, 344	552018-12050H	122, 344	552026-18120H	122, 345
552001-86160	403	552002-42550HK	120, 344	552002-550065	395	552010-12050H	120, 344	552018-18120H	122, 344	552026-18210H	122, 345
552001-86161	403	552002-55100	395	552002-555102	395	552010-18120H	120, 344	552018-18210H	122, 344	552026-341550HK	259
552001-86162	403	552002-55101	395	552002-555142	395	552010-18210H					

Article-No.	Page(s)	Article-No.	Page(s)	Article-No.	Page(s)	Article-No.	Page(s)	Article-No.	Page(s)	Article-No.	Page(s)
552027-342550HK	260	552035-352010HK	259	552114-352050HK	258	553001-37126	430	553002-34149H	435	553003-32050H	127, 349
552027-352010HK	259	552035-352050HK	260	552114-41550HK	120, 346	553001-37127	430	553002-34156H	435	553003-38110H	127, 349
552027-352050HK	260	552035-41550HK	123, 345	552114-42550HK	120, 346	553001-37180	429	553002-34157H	435	553004-32020H	127, 349
552027-41550HK	122, 345	552035-42550HK	123, 345	552115-12020H	120, 346	553001-37182	429	553002-34158H	435	553004-32050H	127, 349
552027-42550HK	122, 345	552036-12020H	123, 345	552115-12050H	120, 346	553001-37183	430	553002-34159H	435	553004-38110H	127, 349
552028-12020H	122, 345	552036-12050H	123, 345	552115-18120H	120, 346	553001-37185	430	553002-34306	441	553006-32020H	127, 349
552028-12050H	122, 345	552036-18120H	123, 345	552115-18210H	120, 346	553001-37188	429	553002-34307	441	553006-32050H	127, 349
552028-18120H	122, 345	552036-18210H	123, 345	552115-341550HK	257	553001-37189	430	553002-34308	441	553006-38110H	127, 349
552028-18210H	122, 345	552036-341550HK	259	552115-342550HK	258	553001-38110H	127, 349	553002-34309	441	553007-32020H	127, 349
552028-341550HK	259	552036-342550HK	260	552115-352010HK	257	553001-38115H	129, 351	553002-37120	429	553007-32050H	127, 349
552028-342550HK	260	552036-352010HK	259	552115-352050HK	258	553001-38116H	129, 351	553002-37121	429	553007-38110H	127, 349
552028-352010HK	259	552036-352050HK	260	552115-41550HK	120, 346	553001-38117H	129, 351	553002-37122	429	553008-32020H	127, 349
552028-352050HK	260	552036-41550HK	123, 345	552115-42550HK	120, 346	553001-38118H	129, 351	553002-37125	430	553008-32050H	127, 349
552028-41550HK	122, 345	552036-42550HK	123, 345	552116-12020H	120, 346	553001-38116H	129, 351	553002-37126	430	553008-38110H	127, 349
552028-42550HK	122, 345	552037-12020H	123, 345	552116-12050H	120, 346	553001-53150	378	553002-37127	430	553010-32020H	127, 349
552029-12020H	122, 345	552037-12050H	123, 345	552116-18120H	120, 346	553001-53159	378	553002-37180	429	553010-32050H	127, 349
552029-12050H	122, 345	552037-18120H	123, 345	552116-18210H	120, 346	553001-55520	423	553002-37182	429	553010-38110H	127, 349
552029-18120H	122, 345	552037-18210H	123, 345	552116-341550HK	257	553001-55522	423	553002-37183	430	553011-32020H	127, 349
552029-18210H	122, 345	552037-341550HK	259	552116-342550HK	258	553001-55526	423	553002-37185	430	553011-32050H	127, 349
552029-341550HK	259	552037-342550HK	260	552116-352010HK	257	553001-55720	372	553002-37188	429	553011-38110H	127, 349
552029-342550HK	260	552037-352010HK	259	552116-352050HK	258	553001-55722	372	553002-37189	430	553011-32020H	127, 349
552029-352010HK	259	552037-352050HK	260	552116-41550HK	120, 346	553001-55725	372	553002-38110H	127, 349	553014-32050H	127, 349
552029-352050HK	260	552037-41550HK	123, 345	552116-42550HK	120, 346	553001-55729	372	553002-38115H	129, 351	553014-38110H	127, 349
552029-41550HK	122, 345	552037-42550HK	123, 345	552117-12020H	120, 345	553001-55730	371	553002-38116H	129, 351	553015-32020H	127, 349
552029-42550HK	122, 345	552038-12020H	123, 345	552117-12050H	120, 345	553001-55732	371	553002-38117H	129, 351	553015-32050H	127, 349
552030-12020H	122, 345	552038-12050H	123, 345	552117-18120H	120, 345	553001-55735	371	553002-38118H	129, 351	553015-38110H	127, 349
552030-12050H	122, 345	552038-18120H	123, 345	552117-18210H	120, 345	553001-55736	371	553002-53150	378	553016-32020H	127, 349
552030-18120H	122, 345	552038-18210H	123, 345	552117-341550HK	257	553001-55737	371	553002-53151	378	553016-32050H	127, 349
552030-18210H	122, 345	552038-341550HK	259	552117-342550HK	258	553001-55738	371	553002-53159	378	553016-38110H	127, 349
552030-341550HK	259	552038-342550HK	260	552117-352010HK	257	553001-55740	373	553002-53320	444	553018-32020H	127, 349
552030-342550HK	260	552038-352010HK	259	552117-352050HK	258	553001-55742	373	553002-53321	444	553018-32050H	127, 349
552030-352010HK	259	552038-352050HK	260	552117-41550HK	120, 345	553001-55745	373	553002-53322	444	553018-38110H	127, 349
552030-352050HK	260	552038-41550HK	123, 345	552117-42550HK	120, 345	553001-55749	373	553002-53323	444	553019-32020H	127, 349
552030-41550HK	122, 345	552038-42550HK	123, 345	552118-12020H	120, 345	553001-55760	372	553002-55720	372	553019-32050H	127, 349
552030-42550HK	122, 345	552039-12020H	123, 345	552118-12050H	120, 345	553001-55762	372	553002-55722	372	553019-38110H	127, 349
552031-12020H	122, 345	552039-12050H	123, 345	552118-18120H	120, 345	553001-55765	372	553002-55725	372	553023-32020H	127, 349
552031-12050H	122, 345	552039-18120H	123, 345	552118-18210H	120, 345	553001-55766	372	553002-55729	372	553023-32050H	127, 349
552031-18120H	122, 345	552039-18210H	123, 345	552118-341550HK	257	553001-55770	372	553002-55730	371	553023-38110H	127, 349
552031-18210H	122, 345	552039-341550HK	259	552118-342550HK	258	553001-55775	372	553002-55732	371	553026-32020H	127, 349
552031-341550HK	259	552039-342550HK	260	552118-352010HK	257	553001-55820	377	553002-55735	371	553026-32050H	127, 349
552031-342550HK	260	552039-352010HK	259	552118-352050HK	258	553001-55821	377	553002-55736	371	553026-38110H	127, 349
552031-352010HK	259	552039-352050HK	260	552118-41550HK	120, 345	553001-55822	377	553002-55737	371	553027-32020H	127, 349
552031-352050HK	260	552039-41550HK	123, 345	552118-42550HK	120, 345	553001-55825	377	553002-55738	371	553027-32050H	127, 349
552031-41550HK	122, 345	552039-42550HK	123, 345	552119-12020H	120, 345	553001-55826	377	553002-55740	373	553027-38110H	127, 349
552031-42550HK	122, 345	552040-12020H	123, 345	552119-12050H	120, 345	553001-55830	377	553002-55742	373	553029-32020H	127, 349
552032-12020H	122, 345	552040-12050H	123, 345	552119-18120H	120, 345	553001-55831	377	553002-55745	373	553031-32050H	127, 349
552032-12050H	122, 345	552040-18120H	123, 345	552119-18210H	120, 345	553001-55832	377	553002-55749	373	553031-38110H	127, 349
552032-18120H	122, 345	552040-18210H	123, 345	552119-341550HK	257	553001-55835	377	553002-55760	372	553033-32020H	127, 349
552032-18210H	122, 345	552040-341550HK	259	552119-342550HK	258	553001-55836	377	553002-55762	372	553033-32050H	127, 349
552032-341550HK	259	552040-342550HK	260	552119-352010HK	257	553001-55840	378	553002-55765	372	553033-38110H	127, 349
552032-342550HK	260	552040-352010HK	259	552119-352050HK	258	553001-55841	378	553002-55766	372	553034-32020H	127, 349
552032-352010HK	259	552040-352050HK	260	552119-41550HK	120, 345	553001-55845	378	553002-55770	372	553034-32050H	127, 349
552032-352050HK	260	552040-41550HK	123, 345	552119-42550HK	120, 345	553001-59420	371	553002-55775	372	553034-38110H	127, 349
552032-41550HK	122, 345	552040-42550HK	123, 345	553001-32020H	127, 349	553001-59422	371	553002-55820	377	553035-32020H	127, 349
552032-42550HK	122, 345	552112-12020H	120, 346	553001-32025H	129, 351	553001-59425	371	553002-55821	377	553035-32050H	127, 349
552033-12020H	123, 345	552112-12050H	120, 346	553001-32027H	129, 351	553001-59426	371	553002-55822	377	553035-38110H	127, 349
552033-12050H	123, 345	552112-18120H	120, 346	553001-32050H	127, 349	553001-59427	371	553002-55825	377	553036-32020H	127, 349
552033-18120H	123, 345	552112-18210H	120, 346	553001-32055H	129, 351	553001-59428	371	553002-55826	377	553036-32050H	127, 349
552033-18210H	123, 345	552112-341550HK	257	553001-32057H	129, 351	553001-59429	371	553002-55830	377	553036-38110H	127, 349
552033-341550HK	259	552112-342550HK	258	553001-34070H	441	553001-59627	437	553002-55831	377	553037-32020H	128, 350
552033-342550HK	260	552112-352010HK	257	553001-34120H	441	553001-59628	437	553002-55832	377	553037-32050H	128, 350
552033-352010HK	259	552112-352050HK	258	553001-34125H	441	553001-59629	437	553002-55835	377	553037-38110H	128, 350
552033-352050HK	260	552112-41550HK	120, 346	553001-34126H	441	553001-59630	437	553002-55836	377	553038-32020H	128, 350
552033-41550HK	123, 345	552112-42550HK	120, 346	553001-34127H	441	553001-59637	437	553002-55840	378	553038-32050H	128, 350
552033-42550HK	123, 345	552113-12020H	120, 346	553001-34128H	441	553001-59638	437	553002-55841	378	553038-38110H	128, 350
552034-12020H	123, 345	552113-12050H	120, 346	553001-34146H	435	553001-59639	437	553002-55845	378	553039-32020H	128, 350
552034-12050H	123, 345	552113-18120H	120, 346	553001-34147H	435	553002-32020H	127, 349	553002-59420	371	553039-32050H	128, 350
552034-18120H	123, 345	552113-18210H	120, 346	553001-34148H	435	553002-32025H	129, 351	553002-59422	371	553039-38110H	128, 350
552034-18210H	123, 345	552113-341550HK	257	553001-34149H	435	553002-32027H	129, 351	553002-59425	371	553040-32020H	128, 350
552034-341550HK	259	552113-342550HK	258	553001-34156H	435	553002-32050H					

Article No.	Page(s)	Article No.	Page(s)	Article No.	Page(s)	Article No.	Page(s)	Article No.	Page(s)	Article No.	Page(s)
553115-32050H	128, 350	554014-32020H	131, 353	555023-34090H	139, 359	555118-27180H	140, 360	5716-55856	403	600356-106-70	111
553115-38110H	128, 350	554014-32050H	131, 353	555023-38110H	138, 358	555118-27181H	140, 360	5716-55875/58	403	600357-103-70	111
553116-32020H	128, 350	554014-38110H	131, 353	555023-42550HK	138, 358	555118-27182H	140, 360	5716-85160	383	600357-106-70	111
553116-32050H	128, 350	554015-32020H	131, 353	555023-42580HK	139, 359	555118-32020H	138, 358	5716-85161	383	600384-070	98
553116-38110H	128, 350	554015-32050H	131, 353	555035-27180H	140, 360	555118-32050H	138, 358	5716-85163	383	600384-072	98
553117-32020H	128, 350	554015-38110H	131, 353	555035-27181H	140, 360	555118-32080H	139, 359	5716-85165	383	600384-073	98
553117-32050H	128, 350	554016-32020H	131, 353	555035-27182H	140, 360	555118-32100H	139, 359	5716-85166	383	600384-075	98
553117-38110H	128, 350	554016-32050H	131, 353	555035-32020H	138, 358	555118-34090H	139, 359	5716-85167/68	383, 387	600416-070	98
553118-32020H	128, 350	554016-38110H	131, 353	555035-32050H	138, 358	555118-38110H	138, 358	5716-85180	385	600416-072	98
553118-32050H	128, 350	554019-32020H	131, 353	555035-32080H	139, 359	555118-42550HK	138, 358	5716-85181	385	600416-073	98
553118-38110H	128, 350	554019-32050H	131, 353	555035-32100H	139, 359	555118-42580HK	139, 359	5716-85183	385	600416-075	98
553119-32020H	128, 350	554019-38110H	131, 353	555035-34090H	139, 359	563-18120	99	5716-85185	385	600417-070	98
553119-32050H	128, 350	554023-32020H	131, 353	555035-38110H	138, 358	5716-17112	427	5716-85186	385	600417-072	98
553119-38110H	128, 350	554023-32050H	131, 353	555035-42550HK	138, 358	5716-17190	427	5716-85187/88	385	600417-073	98
554001-32020H	131, 353	554023-38110H	131, 353	555035-42580HK	139, 359	5716-17191	427	5716-85190	385	600417-075	98
554001-32025H	132, 354	554026-32020H	131, 353	555036-27180H	140, 360	5716-17193	427	5716-85191	385	600420-070	98
554001-32027H	132, 354	554026-32050H	131, 353	555036-27181H	140, 360	5716-17194	427	5716-85193	385	600420-072	98
554001-32050H	131, 353	554026-38110H	131, 353	555036-27182H	140, 360	5716-17196	427	5716-85195	385	600420-073	98
554001-32055H	132, 354	554027-32020H	131, 353	555036-32020H	138, 358	5716-18190	427	5716-85196	385	600420-075	98
554001-32057H	132, 354	554027-32050H	131, 353	555036-32050H	138, 358	5716-18191	427	5716-85197/98	385	600430-070-71	98
554001-37120	429	554027-38110H	131, 353	555036-32080H	139, 359	5716-18192	427	5716-86160	403	600430-072-71	98
554001-37121	429	554031-32020H	131, 353	555036-32100H	139, 359	5716-18193	427	5716-86161	403	600430-075-71	98
554001-37122	429	554031-32050H	131, 353	555036-34090H	139, 359	5716-18194	427	5716-86162	403	600442-070	98
554001-37125	430	554031-38110H	131, 353	555036-38110H	138, 358	5716-18196	427	5716-86163	403	600442-072	98
554001-37126	430	554035-32020H	131, 353	555036-42550HK	138, 358	5716-34126H	441	5716-86165	403	600442-073	98
554001-37127	430	554035-32050H	131, 353	555036-42580HK	139, 359	5716-341550HK	257	5716-86167/68	403	600442-075	98
554001-37180	429	554035-38110H	131, 353	555038-27180H	140, 360	5716-342550HK	258	5716-87160	391	600443-070	98
554001-37182	429	554036-32020H	131, 353	555038-27181H	140, 360	5716-352010HK	257	5716-87161	391	600443-072	98
554001-37183	430	554036-32050H	131, 353	555038-27182H	140, 360	5716-352050HK	258	5716-87163	391	600443-073	98
554001-37185	430	554036-38110H	131, 353	555038-32020H	138, 358	5716-37088	427	5716-87165	391	600443-075	98
554001-37188	429	554038-32020H	131, 353	555038-32050H	138, 358	5716-37120	429	5716-87166	391	600450-070	98
554001-37189	430	554038-32050H	131, 353	555038-32080H	139, 359	5716-37121	429	5716-87167/68	391	600450-072	98
554001-38110H	131, 353	554038-38110H	131, 353	555038-32100H	139, 359	5716-37122	429	5716-95160	387	600450-073	98
554001-38115H	132, 354	554039-32020H	131, 353	555038-34090H	139, 359	5716-37125	430	5716-95161	387	600450-075	98
554001-38116H	132, 354	554039-32050H	131, 353	555038-38110H	138, 358	5716-37126	430	5716-95163	387	600499-070	98
554001-38117H	132, 354	554039-38110H	131, 353	555038-42550HK	138, 358	5716-37127	430	5716-95165	387	600499-072	98
554001-38118H	132, 354	554040-32020H	131, 353	555038-42580HK	139, 359	5716-37180	429	5716-95166	387	600499-073	98
554002-32020H	131, 353	554040-32050H	131, 353	555039-27180H	140, 360	5716-37182	429	5716-95180	387	600499-075	98
554002-32025H	132, 354	554040-38110H	131, 353	555039-27181H	140, 360	5716-37183	430	5716-95181	387	600859-504	96
554002-32027H	132, 354	554111-32020H	131, 353	555039-27182H	140, 360	5716-37185	430	5716-95183	387	600859-505	96
554002-32050H	131, 353	554111-32025H	132, 354	555039-32020H	138, 358	5716-37186	427	5716-95185	387	600864-504	96
554002-32055H	132, 354	554111-32027H	132, 354	555039-32050H	138, 358	5716-37188	429	5716-95186	387	600864-505	96
554002-32057H	132, 354	554111-32050H	131, 353	555039-32080H	139, 359	5716-37189	430	5716-950044	383	601500-070-71	97
554002-37120	429	554111-32055H	132, 354	555039-32100H	139, 359	5716-41550HK	120, 344	5716-950065	395	601500-072-71	97
554002-37121	429	554111-32057H	132, 354	555039-34090H	139, 359	5716-55100	395	5716-55102	395	601500-075-71	97
554002-37122	429	554111-37120	429	555039-38110H	138, 358	5716-55101	395	5716-55142	395	601550-070-71	97
554002-37125	430	554111-37121	429	555039-42550HK	138, 358	5716-55105	395	5716-55182	383	601550-072-71	97
554002-37126	430	554111-37122	429	555039-42580HK	139, 359	5716-55106	395	5716-585162	383	601550-075-71	97
554002-37127	430	554111-37125	430	555040-27180H	140, 360	5716-55107/08	395	5716-585182	385	610-2008	276
554002-37180	429	554111-37126	430	555040-27181H	140, 360	5716-55140	395	5716-585192	385	610-2016	276
554002-37182	429	554111-37127	430	555040-27182H	140, 360	5716-55141	395	5716-587162	391	610-2023	276
554002-37183	430	554111-37180	429	555040-32020H	138, 358	5716-55143	395	5716-595162	387	610-2033	276
554002-37185	430	554111-37182	429	555040-32050H	138, 358	5716-55145	395	5716-595182	387	610-2038	276
554002-37188	429	554111-37183	430	555040-32080H	139, 359	5716-55146	395	5716i-12020H	120, 344	610-2039	276
554002-37189	430	554111-37185	430	555040-32100H	139, 359	5716-55147/48	395	5716i-12023H	121, 347	610-2040	276
554002-38110H	131, 353	554111-37188	429	555040-34090H	139, 359	5716-55180	383	5716i-12050H	120, 344	610-2041	276
554002-38115H	132, 354	554111-37189	430	555040-38110H	138, 358	5716-55181	383	5716i-12053H	121, 347	610-2042	276
554002-38116H	132, 354	554111-38110H	131, 353	555040-42550HK	138, 358	5716-55185	383	5716i-18120H	120, 344	610-2043	276
554002-38117H	132, 354	554111-38115H	132, 354	555040-42580HK	139, 359	5716-55186	383	5716i-18123H	121, 347	610-2111	276
554002-38118H	132, 354	554111-38116H	132, 354	555113-27180H	140, 360	5716-55187/88	383, 387	5716i-18124H	121, 347	610-2113	276
554003-32020H	131, 353	554111-38117H	132, 354	555113-27181H	140, 360	5716-55440	422	5716i-18210H	120, 344	620241-070	97
554003-32050H	131, 353	554111-38118H	132, 354	555113-27182H	140, 360	5716-55442	422	5716i-18213H	121, 347	620241-072	97
554003-38110H	131, 353	554113-32020H	131, 353	555113-32020H	138, 358	5716-55445	422	5716i-18214H	121, 347	620241-073	97
554004-32020H	131, 353	554113-32050H	131, 353	555113-32050H	138, 358	5716-55446	422	5716i-34070H	441	620241-075	97
554004-32050H	131, 353	554113-38110H	131, 353	555113-32080H	139, 359	5716-55460	423	5716i-34120H	441	620245-072	97
554004-38110H	131, 353	554117-32020H	131, 353	555113-32100H	139, 359	5716-55462	423	5716i-34125H	441	620249-070	97
554006-32020H	131, 353	554117-32050H	131, 353	555113-34090H	139, 359	5716-55465	423	5716i-34127H	441	620249-072	97
554006-32050H	131, 353	554117-38110H	131, 353	555113-38110H	138, 358	5716-55466	423	5716i-34128H	441	620249-073	97
554006-38110H	131, 353	554118-32020H	131, 353	555113-42550HK	138, 358	5716-55561	442	5716i-34170H	441	620249-075	97
554007-32020H	131, 353	554118-32050H	131, 353	555113-42580HK	139, 359	5716-55562	442	5716i-42550HK	120, 344	620290-070	97
554007-32050H	131, 353	554118-38110H	131, 353	555117-27180H	140, 360	5716-55563	442	590-37040-21	161	620290-072	97
554007-38110H	131, 353	554119-32020H	131, 353	555117-27181H	140, 360	5716-55565	442	590-37042-21	161	620290-073	97
554008-32020H	131, 353	554119-32050H	131, 353	555117-27182H	140, 360	5716-55566	442	590-37043-21	161	620290-075	97
554008-32050H	1										

Article-No.	Page(s)	Article-No.	Page(s)	Article-No.	Page(s)	Article-No.	Page(s)	Article-No.	Page(s)	Article-No.	Page(s)
620460-072	97	700-55440	422	700i-18120H	120, 344	701-2120H	257	701-85167/68	383, 387	702-2013H	257
620460-073	97	700-55442	422	700i-18123H	121, 347	701-34020	428	701-85180	385	702-2014H	257
620460-075	97	700-55445	422	700i-18124H	121, 347	701-37011	443	701-85181	385	702-2015H	257
620470-070	97	700-55446	422	700i-18210H	120, 344	701-37015	443	701-85183	385	702-2016H	257
620470-072	97	700-55460	423	700i-18213H	121, 347	701-37017	443	701-85185	385	702-2017H	259
620470-073	97	700-55462	423	700i-18214H	121, 347	701-37018	443	701-85186	385	702-2018H	259
620470-075	97	700-55465	423	700i-34070H	441	701-37021	428	701-85187/88	385	702-2019H	259
620480-072	97	700-55466	423	700i-34120H	441	701-37023	428	701-85190	385	702-2020H	259
620480-075	97	700-55561	442	700i-34125H	441	701-37024	428	701-85191	385	702-2021H	259
620490-072	97	700-55562	442	700i-34126H	441	701-37031	443	701-85193	385	702-2022H	259
620490-075	97	700-55563	442	700i-34127H	441	701-37035	443	701-85195	385	702-2023H	259
620510-070	97	700-55565	442	700i-34128H	441	701-37080	428	701-85196	385	702-2024H	259
620510-072	97	700-55566	442	700i-341550HK	257	701-37081	428	701-85197/98	385	702-2025H	259
620510-073	97	700-55567	442	700i-34170H	441	701-37082	428	701-86160	403	702-2026H	259
620510-075	97	700-55800	423	700i-342550HK	258	701-37088	427	701-86161	403	702-2027H	259
620805-504	96	700-55802	423	700i-352010HK	257	701-37090	428	701-86162	403	702-2028H	259
620805-505	96	700-55805	423	700i-352050HK	258	701-37091	428	701-86163	403	702-2029H	259
620806-504	96	700-55806	423	700i-41550HK	120, 344	701-37092	428	701-86165	403	702-2030H	259
620806-505	96	700-55850	403	700i-42550HK	120, 344	701-37120	429	701-86167/68	403	702-2031H	259
620811-504	96	700-55852	403	701-17112	427	701-37121	429	701-87160	391	702-2032H	259
620811-505	96	700-55855	403	701-17190	427	701-37122	429	701-87161	391	702-2033H	259
623060-070	98	700-55856	403	701-17191	427	701-37125	430	701-87163	391	702-2034H	259
623060-072	98	700-55857/58	403	701-17193	427	701-37126	430	701-87165	391	702-2035H	259
623060-073	98	700-59680	443	701-17194	427	701-37127	430	701-87166	391	702-2036H	259
623060-075	98	700-59681	443	701-17196	427	701-37180	429	701-87167/68	391	702-2037H	259
700-17112	427	700-59685	443	701-18120	99	701-37182	429	701-95160	387	702-2038H	259
700-17190	427	700-85160	383	701-18190	427	701-37183	430	701-95161	387	702-2039H	259
700-17191	427	700-85161	383	701-18191	427	701-37185	430	701-95163	387	702-2040H	259
700-17193	427	700-85163	383	701-18192	427	701-37186	427	701-95165	387	702-2111H	257
700-17194	427	700-85165	383	701-18193	427	701-37188	429	701-95166	387	702-2112H	257
700-17196	427	700-85166	383	701-18194	427	701-37189	430	701-95180	387	702-2113H	257
700-18120	99	700-85167/68	383, 387	701-18196	427	701-38110	99	701-95181	387	702-2114H	257
700-18190	427	700-85180	385	701-2001H	257	701-44025	428	701-95183	387	702-2115H	257
700-18191	427	700-85181	385	701-2002H	257	701-44026	428	701-95185	387	702-2116H	257
700-18192	427	700-85183	385	701-2003H	257	701-55100	395	701-95186	387	702-2117H	257
700-18193	427	700-85185	385	701-2004H	257	701-55101	395	701-550044	383	702-2118H	257
700-18194	427	700-85186	385	701-2005H	257	701-55105	395	701-550065	395	702-2119H	257
700-18196	427	700-85187/88	385	701-2006H	257	701-55106	395	701-555102	395	702-2120H	257
700-37011	443	700-85190	385	701-2007H	257	701-55107/08	395	701-555142	395	703-18120	99
700-37015	443	700-85191	385	701-2008H	257	701-55140	395	701-555182	383	703-2001H	257
700-37017	443	700-85193	385	701-2009H	257	701-55141	395	701-585162	383	703-2002H	257
700-37018	443	700-85195	385	701-2010H	257	701-55143	395	701-585182	385	703-2003H	257
700-37021	428	700-85196	385	701-2011H	257	701-55145	395	701-585192	385	703-2004H	257
700-37023	428	700-85197/98	385	701-2012H	257	701-55146	395	701-587162	391	703-2005H	257
700-37024	428	700-86160	403	701-2013H	257	701-55147/48	395	701-595162	387	703-2006H	257
700-37031	443	700-86161	403	701-2014H	257	701-55180	383	701-595182	387	703-2007H	257
700-37035	443	700-86162	403	701-2015H	257	701-55181	383	701i-12020H	120, 344	703-2008H	257
700-37080	428	700-86163	403	701-2016H	257	701-55185	383	701i-12023H	121, 347	703-2009H	257
700-37081	428	700-86165	403	701-2017H	259	701-55186	383	701i-12050H	120, 344	703-2010H	257
700-37082	428	700-86167/68	403	701-2018H	259	701-55187/88	383, 387	701i-12053H	121, 347	703-2011H	257
700-37088	427	700-87160	391	701-2019H	259	701-55440	422	701i-18120H	120, 344	703-2012H	257
700-37120	429	700-87161	391	701-2020H	259	701-55442	422	701i-18123H	121, 347	703-2013H	257
700-37121	429	700-87163	391	701-2021H	259	701-55445	422	701i-18124H	121, 347	703-2014H	257
700-37122	429	700-87165	391	701-2022H	259	701-55446	422	701i-18210H	120, 344	703-2015H	257
700-37125	430	700-87166	391	701-2023H	259	701-55460	423	701i-18213H	121, 347	703-2016H	257
700-37126	430	700-87167/68	391	701-2024H	259	701-55462	423	701i-18214H	121, 347	703-2017H	259
700-37127	430	700-95160	387	701-2025H	259	701-55465	423	701i-34070H	441	703-2018H	259
700-37180	429	700-95161	387	701-2026H	259	701-55466	423	701i-34120H	441	703-2019H	259
700-37182	429	700-95163	387	701-2027H	259	701-55561	442	701i-34125H	441	703-2020H	259
700-37183	430	700-95165	387	701-2028H	259	701-55562	442	701i-34126H	441	703-2021H	259
700-37185	430	700-95166	387	701-2029H	259	701-55563	442	701i-34127H	441	703-2022H	259
700-37186	427	700-95180	387	701-2030H	259	701-55565	442	701i-34128H	441	703-2023H	259
700-37188	429	700-95181	387	701-2031H	259	701-55566	442	701i-341550HK	257	703-2024H	259
700-37189	430	700-95183	387	701-2032H	259	701-55567	442	701i-34170H	441	703-2025H	259
700-38110	99	700-95185	387	701-2033H	259	701-55800	423	701i-342550HK	258	703-2026H	259
700-55100	395	700-95186	387	701-2034H	259	701-55802	423	701i-352010HK	257	703-2027H	259
700-55101	395	700-550044	383	701-2035H	259	701-55805	423	701i-352050HK	258	703-2028H	259
700-55105	395	700-550065	395	701-2036H	259	701-55806	423	701i-41550HK	120, 344	703-2029H	259
700-55106	395	700-555102	395	701-2037H	259	701-55850	403	701i-42550HK	120, 344	703-2030H	259
700-55107/08	395	700-555142	395	701-2038H	259	701-55852	403	702-2001H	257	703-2031H	259
700-55140	395	700-555182	383	701-2039H	259	701-55855	403	702-2002H	257	703-2032H	259
700-55141	395	700-585162	383	701-2040H	259	701-55856	403	702-2003H	257	703-2033H	259
700-55143	395	700-585182	385	701-2111H	257	701-55857/58	403	702-2004H	257	703-2034H	259
700-55145	395	700-585192	385	701-2112H	257	701-59680	443	702-2005H	257	703-2035H	259
700-55146	395	700-587162	391	701-2113H	257	701-59681	443	702-2006H	257	703-2036H	259
700-55147/48	395	700-595162	387	701-2114H	257	701-59685	443	702-2007H	257	703-2037H	259
700-55180	383	700-595182	387	701-2115H	257	701-85160	383	702-2008H	257	703-2038H	259
700-55181	383	700i-12020H	120, 344	701-2116H	257	701-85161	383	702-2009H	257	703-2039H	259
700-55185	383	700i-12023H	121, 347	701-2117H	257	701-85163	383	702-2010H	257	703-2040H	259
700-55186	383	700i-12050H	120, 344	701-2118H	257	701-85165	383	702-2011H	257	703-2111H	257
700-55187/88	383, 387	700i-12053H	121, 347	701-2119H	257	701-85166	383	702-2012H	257	703-2112H	257

Article No.	Page(s)	Article No.	Page(s)	Article No.	Page(s)	Article No.	Page(s)	Article No.	Page(s)	Article No.	Page(s)
703-2113H	257	710-2021H	259	715-2113H	258	730-2018H	260	740-2117H	258	760-2121H	258
703-2114H	257	710-2022H	259	715-2114H	258	730-2019H	260	740-2118H	258	761-2001H	262, 269
703-2115H	257	710-2023H	259	715-2115H	258	730-2020H	260	740-2119H	258	761-2002H	262, 269
703-2116H	257	710-2024H	259	715-2116H	258	730-2021H	260	740-2120H	258	761-2003H	262, 269
703-2117H	257	710-2025H	259	715-2117H	258	730-2022H	260	759-2001H	262, 269	761-2004H	262, 269
703-2118H	257	710-2026H	259	715-2118H	258	730-2023H	260	759-2002H	262, 269	761-2006H	262, 269
703-2119H	257	710-2027H	259	715-2119H	258	730-2024H	260	759-2003H	262, 269	761-2007H	262, 269
703-2120H	257	710-2028H	259	715-2120H	258	730-2025H	260	759-2004H	262, 269	761-2008H	262, 269
703-2121H	257	710-2029H	259	717i-12020H	123, 346	730-2026H	260	759-2006H	262, 269	761-2011H	262, 269
703-38110	99	710-2030H	259	717i-12050H	123, 346	730-2027H	260	759-2007H	262, 269	761-2015H	262, 269
705-2001H	257	710-2031H	259	717i-18120H	123, 346	730-2028H	260	759-2008H	262, 269	761-2016H	262, 269
705-2002H	257	710-2032H	259	717i-18210H	123, 346	730-2029H	260	759-2011H	262, 269	761-2019H	262, 271
705-2003H	257	710-2033H	259	717i-41550HK	123, 346	730-2030H	260	759-2015H	262, 269	761-2023H	262, 271
705-2004H	257	710-2034H	259	717i-42550HK	123, 346	730-2031H	260	759-2016H	262, 269	761-2027H	262, 271
705-2005H	257	710-2035H	259	720-2001H	258	730-2032H	260	759-2019H	262, 271	761-2031H	262, 271
705-2006H	257	710-2036H	259	720-2002H	258	730-2033H	260	759-2023H	262, 271	761-2034H	262, 271
705-2007H	257	710-2037H	259	720-2003H	258	730-2034H	260	759-2027H	262, 271	761-2036H	262, 271
705-2008H	257	710-2038H	259	720-2004H	258	730-2035H	260	759-2031H	262, 271	761-2037H	262, 271
705-2009H	257	710-2039H	259	720-2005H	258	730-2036H	260	759-2034H	262, 271	761-2040H	262, 271
705-2010H	257	710-2040H	259	720-2006H	258	730-2037H	260	759-2036H	262, 271	761-2111H	262, 269
705-2011H	257	710-2111H	257	720-2007H	258	730-2038H	260	759-2037H	262, 271	761-2113H	262, 269
705-2012H	257	710-2112H	257	720-2008H	258	730-2039H	260	759-2040H	262, 271	761-2115H	262, 269
705-2013H	257	710-2113H	257	720-2009H	258	730-2040H	260	759-2111H	262, 269	761-2117H	262, 269
705-2014H	257	710-2114H	257	720-2010H	258	730-2111H	258	759-2113H	262, 269	761-2118H	262, 269
705-2015H	257	710-2115H	257	720-2011H	258	730-2112H	258	759-2115H	262, 269	761-2119H	262, 269
705-2016H	257	710-2116H	257	720-2012H	258	730-2113H	258	759-2117H	262, 269	761-2120H	262, 269
705-2017H	259	710-2117H	257	720-2013H	258	730-2114H	258	759-2118H	262, 269	763-2003H	262
705-2018H	259	710-2118H	257	720-2014H	258	730-2115H	258	759-2119H	262, 269	763-2034H	262
705-2019H	259	710-2119H	257	720-2015H	258	730-2116H	258	759-2120H	262, 269	763-2036H	262
705-2020H	259	710-2120H	257	720-2016H	258	730-2117H	258	75917-8110	99	763-2037H	262
705-2021H	259	710-2121H	257	720-2017H	260	730-2118H	258	75918-8110	99	763-2040H	262
705-2022H	259	710-2504H	261	720-2018H	260	730-2119H	258	760-2001H	258	763-2111H	262
705-2023H	259	710-2508H	261	720-2019H	260	730-2120H	258	760-2002H	258	763-2115H	262
705-2024H	259	710-2512H	261	720-2020H	260	730-2121H	258	760-2003H	258	763-2118H	262
705-2025H	259	710-2516H	261	720-2021H	260	732-18120	99	760-2004H	258	763-2120H	262
705-2026H	259	710-2520H	261	720-2022H	260	740-2001H	258	760-2005H	258	764-2001H	269
705-2027H	259	710-2524H	261	720-2023H	260	740-2002H	258	760-2006H	258	764-2002H	269
705-2028H	259	711-18120	99	720-2024H	260	740-2003H	258	760-2007H	258	764-2003H	269
705-2029H	259	71152-8110	99	720-2025H	260	740-2004H	258	760-2008H	258	764-2004H	269
705-2030H	259	715-2001H	258	720-2026H	260	740-2005H	258	760-2009H	258	764-2006H	269
705-2031H	259	715-2002H	258	720-2027H	260	740-2006H	258	760-2010H	258	764-2007H	269
705-2032H	259	715-2003H	258	720-2028H	260	740-2007H	258	760-2011H	258	764-2008H	269
705-2033H	259	715-2004H	258	720-2029H	260	740-2008H	258	760-2012H	258	764-2011H	269
705-2034H	259	715-2005H	258	720-2030H	260	740-2009H	258	760-2013H	258	764-2015H	269
705-2035H	259	715-2006H	258	720-2031H	260	740-2010H	258	760-2014H	258	764-2016H	269
705-2036H	259	715-2007H	258	720-2032H	260	740-2011H	258	760-2015H	258	764-2019H	271
705-2037H	259	715-2008H	258	720-2033H	260	740-2012H	258	760-2016H	258	764-2023H	271
705-2038H	259	715-2009H	258	720-2034H	260	740-2013H	258	760-2017H	260	764-2027H	271
705-2039H	259	715-2010H	258	720-2035H	260	740-2014H	258	760-2018H	260	764-2031H	271
705-2040H	259	715-2011H	258	720-2036H	260	740-2015H	258	760-2019H	260	764-2034H	271
705-2111H	257	715-2012H	258	720-2037H	260	740-2016H	258	760-2020H	260	764-2036H	271
705-2112H	257	715-2013H	258	720-2038H	260	740-2017H	260	760-2021H	260	764-2037H	271
705-2113H	257	715-2014H	258	720-2039H	260	740-2018H	260	760-2022H	260	764-2040H	271
705-2114H	257	715-2015H	258	720-2040H	260	740-2019H	260	760-2023H	260	764-2111H	269
705-2115H	257	715-2016H	258	720-2111H	258	740-2020H	260	760-2024H	260	764-2113H	269
705-2116H	257	715-2017H	260	720-2112H	258	740-2021H	260	760-2025H	260	764-2115H	269
705-2117H	257	715-2018H	260	720-2113H	258	740-2022H	260	760-2026H	260	764-2117H	269
705-2118H	257	715-2019H	260	720-2114H	258	740-2023H	260	760-2027H	260	764-2118H	269
705-2119H	257	715-2020H	260	720-2115H	258	740-2024H	260	760-2028H	260	764-2119H	269
705-2120H	257	715-2021H	260	720-2116H	258	740-2025H	260	760-2029H	260	764-2120H	269
705-2121H	257	715-2022H	260	720-2117H	258	740-2026H	260	760-2030H	260	77i-32020H	128, 350
710-2001H	257	715-2023H	260	720-2118H	258	740-2027H	260	760-2031H	260	77i-32050H	128, 350
710-2002H	257	715-2024H	260	720-2119H	258	740-2028H	260	760-2032H	260	77i-38110H	128, 350
710-2003H	257	715-2025H	260	720-2120H	258	740-2029H	260	760-2033H	260	785-2001H	269
710-2004H	257	715-2026H	260	730-2001H	258	740-2030H	260	760-2034H	260	785-2002H	269
710-2005H	257	715-2027H	260	730-2002H	258	740-2031H	260	760-2035H	260	785-2003H	269
710-2006H	257	715-2028H	260	730-2003H	258	740-2032H	260	760-2036H	260	785-2004H	269
710-2007H	257	715-2029H	260	730-2004H	258	740-2033H	260	760-2037H	260	785-2006H	269
710-2008H	257	715-2030H	260	730-2005H	258	740-2034H	260	760-2038H	260	785-2007H	269
710-2009H	257	715-2031H	260	730-2006H	258	740-2035H	260	760-2039H	260	785-2008H	269
710-2010H	257	715-2032H	260	730-2007H	258	740-2036H	260	760-2040H	260	785-2011H	269
710-2011H	257	715-2033H	260	730-2008H	258	740-2037H	260	760-2111H	258	785-2015H	269
710-2012H	257	715-2034H	260	730-2009H	258	740-2038H	260	760-2112H	258	785-2016H	269
710-2013H	257	715-2035H	260	730-2010H	258	740-2039H	260	760-2113H	258	785-2019H	271
710-2014H	257	715-2036H	260	730-2011H	258	740-2040H	260	760-2114H	258	785-2023H	271
710-2015H	257	715-2037H	260	730-2012H	258	740-2111H	258	760-2115H	258	785-2027H	271
710-2016H	257	715-2038H	260	730-2013H	258	740-2112H	258	760-2116H	258	785-2031H	271
710-2017H	259	715-2039H	260	730-2014H	258	740-2113H	258	760-2117H	258	785-2034H	271
710-2018H	259	715-2040H	260	730-2015H	258	740-2114H	258	760-2118H	258	785-2036H	271
710-2019H	259	715-2111H	258	730-2016H	258	740-2115H	258	760-2119H	258	785-2037H	271
710-2020H	259	715-2112H	258	730-2017H	260	740-2116H	258	760-2120H	258	785-2040H	271

Article-No.	Page(s)	Article-No.	Page(s)	Article-No.	Page(s)	Article-No.	Page(s)	Article-No.	Page(s)	Article-No.	Page(s)
785-2111H	269	815-2042	277	8461-342550HK	289	851-1010	224	8802-B600HK	296	900-34118	434
785-2113H	269	815-2043	277	8461-342580HK	289	851-1020	224	8802-B611HK	296	900-34119	434
785-2115H	269	815-2111	277	8461-38110H	289	851-1030	224	8802-B670HK	296	900-37088	427
785-2117H	269	815-2113	277	8461-53150	291, 379	851-1630	224	8803-B200HK	296	900-37120	429
785-2118H	269	81i-32020H	131, 353	8461-53151	291, 379	851-2110	147	8803-B600HK	296	900-37121	429
785-2119H	269	81i-32025H	132, 354	8461-53159	291, 379	851-2541	226	8803-B611HK	296	900-37122	429
785-2120H	269	81i-32027H	132, 354	8461-53320	291, 445	851-4822	225	8803-B670HK	296	900-37125	430
786-2001H	269	81i-32050H	131, 353	8461-53321	291, 445	851-4825	225	8804-B200HK	296	900-37126	430
786-2002H	269	81i-32055H	132, 354	8461-53322	291, 445	851-9063	225	8804-B600HK	296	900-37127	430
786-2003H	269	81i-32057H	132, 354	8461-53323	291, 445	851-9066	225	8804-B611HK	296	900-37150	442
786-2004H	269	81i-38110H	131, 353	8461-61061HK	291	851-9330	226	8804-B670HK	296	900-37155	442
786-2006H	269	81i-38115H	132, 354	8461-7161H	289	851-9335	226	8810-342030H	296	900-37180	429
786-2007H	269	81i-38116H	132, 354	8461-B200HK	289	851-9337	226	8810-7161H	296	900-37182	429
786-2008H	269	81i-38117H	132, 354	8462-32020H	289	851-9338	226	8810-B200HK	296	900-37183	430
786-2011H	269	81i-38118H	132, 354	8462-332050HK	289	851-9822	226	8810-B600HK	296	900-37185	430
786-2015H	269	8450-332050HK	289	8462-34090H	289	854-1010	224	8811-342030H	296	900-37186	427
786-2016H	269	8450-342550HK	289	8462-342030H	289	854-1020	224	8811-7161H	296	900-37188	429
786-2019H	271	8450-342557HK	290	8462-342550HK	289	854-1030	224	8811-B200HK	296	900-37189	430
786-2023H	271	8450-B200HK	289	8462-342580HK	289	854-1630	224	8811-B600HK	296	900-4030	181
786-2027H	271	8450-B600HK	289	8462-38110H	289	854-2110	147	8812-342030H	296	900-4033	181
786-2031H	271	8450-B611HK	290	8462-53150	291, 379	854-2541	226	8812-7161H	296	900-4034	181
786-2034H	271	8450-B612HK	290	8462-53151	291, 379	854-4822	225	8812-B200HK	296	900-4822	181
786-2036H	271	8450-B775HK	290	8462-53159	291, 379	854-4825	225	8812-B600HK	296	900-53130	436
786-2037H	271	8450-B776HK	290	8462-53320	291, 445	854-9063	225	8813-342030H	296	900-53135	436
786-2040H	271	8451-332050HK	289	8462-53321	291, 445	854-9066	225	8813-7161H	296	900-53136	436
786-2111H	269	8451-342550HK	289	8462-53322	291, 445	854-9330	226	8813-B200HK	296	900-53137	436
786-2113H	269	8451-342557HK	290	8462-53323	291, 445	854-9335	226	8813-B600HK	296	900-53138	436
786-2115H	269	8451-B200HK	289	8462-53510H	453	854-9337	226	8814-342030H	296	900-53139	436
786-2117H	269	8451-B600HK	289	8462-53511H	453	854-9338	226	8814-7161H	296	900-53150	378
786-2118H	269	8451-B611HK	290	8462-53512H	453	854-9822	226	8814-B200HK	296	900-53151	378
786-2119H	269	8451-B612HK	290	8462-61061HK	291	855-1010	224	8814-B600HK	296	900-53159	378
786-2120H	269	8451-B775HK	290	8462-7161H	289	855-1020	224	8823-B700HK	302	900-53190	436
78i-32020H	131, 353	8451-B776HK	290	8462-B200HK	289	855-1030	224	8823-B710HK	302	900-53195	436
78i-32050H	131, 353	8452-332050HK	289	8463-32020H	289	855-1630	224	8823-B729HK	302	900-53196	436
78i-38110H	131, 353	8452-342550HK	289	8463-332050HK	289	855-2110	147	8823-B755HK	302	900-53197	436
806-2038	277	8452-342557HK	290	8463-34090H	289	855-2541	226	8823-B770HK	302	900-53198	436
806-2042	277	8452-B200HK	289	8463-342030H	289	855-4822	225	885-2008	277	900-53199	436
806-2111	277	8452-B600HK	289	8463-342550HK	289	855-4825	225	885-2023	277	900-54420	446
806-2113	277	8452-B611HK	290	8463-342580HK	289	855-9063	225	885-2038	277	900-54421	446
81-37120	429	8452-B612HK	290	8463-38110H	289	855-9066	225	885-2039	277	900-54422	446
81-37121	429	8452-B775HK	290	8463-53150	291, 379	855-9330	226	885-2040	277	900-54423	446
81-37122	429	8452-B776HK	290	8463-53151	291, 379	855-9335	226	885-2041	277	900-55440	422
81-37125	430	8453-332050HK	289	8463-53159	291, 379	855-9337	226	885-2042	277	900-55442	422
81-37126	430	8453-342550HK	289	8463-53320	291, 445	855-9338	226	885-2043	277	900-55445	422
81-37127	430	8453-342557HK	290	8463-53321	291, 445	855-9822	226	885-2111	277	900-55446	422
81-37180	429	8453-B200HK	289	8463-53322	291, 445	856-1010	224	885-2113	277	900-55750	373
81-37182	429	8453-B600HK	289	8463-53323	291, 445	856-1020	224	886-2008	277	900-55752	373
81-37183	430	8453-B611HK	290	8463-7161H	289	856-1030	224	886-2023	277	900-55755	373
81-37185	430	8453-B612HK	290	8463-B200HK	289	856-1630	224	886-2038	277	900-55759	373
81-37188	429	8453-B775HK	290	8464-32020H	289	856-2110	147	886-2039	277	900-55840	378
81-37189	430	8453-B776HK	290	8464-332050HK	289	856-2541	226	886-2040	277	900-55841	378
810-2008	276	8454-332050HK	289	8464-34090H	289	856-4822	225	886-2041	277	900-55845	378
810-2016	276	8454-342550HK	289	8464-342030H	289	856-4825	225	886-2042	277	900039-55450	422
810-2023	276	8454-342557HK	290	8464-342550HK	289	856-9063	225	886-2043	277	900039-55452	422
810-2033	276	8454-B200HK	289	8464-342580HK	289	856-9066	225	886-2111	277	900039-55455	422
810-2038	276	8454-B600HK	289	8464-38110H	289	856-9330	226	886-2113	277	900039-55456	422
810-2039	276	8454-B611HK	290	8464-53150	291, 379	856-9335	226	900-1100	181	900044-34146H	435
810-2040	276	8454-B612HK	290	8464-53151	291, 379	856-9337	226	900-1110	181	900044-34147H	435
810-2041	276	8454-B775HK	290	8464-53159	291, 379	856-9338	226	900-1160	181	900044-34148H	435
810-2042	276	8454-B776HK	290	8464-53320	291, 445	856-9822	226	900-17112	427	900044-34149H	435
810-2043	276	8460-32020H	289	8464-53321	291, 445	864-2008	277	900-17119	427	900044-34156H	435
810-2111	276	8460-332050HK	289	8464-53322	291, 445	864-2016	277	900-17191	427	900044-34157H	435
810-2113	276	8460-34090H	289	8464-53323	291, 445	864-2023	277	900-17193	427	900044-34158H	435
811-2038	276	8460-342030H	289	8464-7161H	289	864-2033	277	900-17194	427	900044-34159H	435
811-2042	276	8460-342550HK	289	8464-B200HK	289	864-2038	277	900-17196	427	900044-55720	372
811-2111	276	8460-342580HK	289	8471-B610HK	611	864-2039	277	900-18190	427	900044-55722	372
811-2113	276	8460-38110H	289	8471-B620HK	609	864-2040	277	900-18191	427	900044-55725	372
812-2038	276	8460-53150	291, 379	8471-B629HK	610	864-2041	277	900-18192	427	900044-55729	372
812-2042	276	8460-53151	291, 379	8471-B660HK	609	864-2042	277	900-18193	427	900044-55730	371
812-2111	276	8460-53159	291, 379	8471-B670HK	610	864-2043	277	900-18194	427	900044-55732	371
812-2113	276	8460-53320	291, 445	8471-B690HK	608	864-2111	277	900-18196	427	900044-55735	371
813-2038	276	8460-53321	291, 445	8471-B695HK	608	864-2113	277	900-34100	434	900044-55736	371
813-2042	276	8460-53322	291, 445	8471-B698HK	611	8800-B200HK	296	900-34105	434	900044-55737	371
813-2111	276	8460-53323	291, 445	8472-B610HK	611	8800-B600HK	296	900-34106	434	900044-55738	371
813-2113	276	8460-61061HK	291	8472-B620HK	609	8800-B611HK	296	900-34107	434	900044-55740	373
815-2008	277	8460-7161H	289	8472-B629HK	610	8800-B670HK	296	900-34108	434	900044-55742	373
815-2023	277	8460-B200HK	289	8472-B660HK	609	8801-B200HK	296	900-34109	434	900044-55745	373
815-2038	277	8461-32020H	289	8472-B670HK	610	8801-B600HK	296	900-34110	434	900044-55749	373
815-2039	277	8461-332050HK	289	8472-B690HK	608	8801-B611HK	296	900-34115	434	900044-55760	372
815-2040	277	8461-34090H	289	8472-B695HK	608	8801-B670HK	296	900-34116	434	900044-55762	372
815-2041	277	8461-342030H	289	8472-B698HK	611	8802-B200HK	296	900-34117	434	900044-55765	372

690 ARTICLE NUMBERS

Article No.	Page(s)	Article No.	Page(s)	Article No.	Page(s)	Article No.	Page(s)	Article No.	Page(s)	Article No.	Page(s)
900044-55766	372	900588-34156H	435	901i-32020H	138, 358	9022-2720	148	9032-4822	148	91-53135	436
900044-55770	372	900588-34157H	435	901i-32050H	138, 358	9022-2721	148	9032-9220	148	91-53136	436
900044-55775	372	900588-34158H	435	901i-32080H	139, 359	9022-4822	148	9033-2120	147	91-53137	436
900044-59420	371	900588-34159H	435	901i-32100H	139, 359	9022-9220	148	9033-2240	147	91-53138	436
900044-59422	371	900588-55720	372	901i-34020H	141, 361	9023-2120	147	9033-2250	147	91-53139	436
900044-59425	371	900588-55722	372	901i-34090H	139, 359	9023-2240	147	9033-2270	147	91-53150	378
900044-59426	371	900588-55725	372	901i-38110H	138, 358	9023-2250	147	9033-2280	147	91-53151	378
900044-59427	371	900588-55729	372	901i-42550HK	138, 358	9023-2270	147	9033-2521	148	91-53159	378
900044-59428	371	900588-55730	371	901i-42580HK	139, 359	9023-2280	147	9033-2720	148	91-53190	436
900044-59620	437	900588-55732	371	902-2001H	268	9023-9220	148	9033-2721	148	91-53195	436
900044-59627	437	900588-55735	371	902-2002H	268	9024-2120	147	9033-4822	148	91-53196	436
900044-59628	437	900588-55736	371	902-2003H	268	9024-2240	147	9033-9220	148	91-53197	436
900044-59629	437	900588-55737	371	902-2004H	268	9024-2250	147	905-2001H	268	91-53198	436
900044-59630	437	900588-55738	371	902-2005H	268	9024-2270	147	905-2002H	268	91-53199	436
900044-59637	437	900588-55740	373	902-2006H	268	9024-2280	147	905-2003H	268	91-53320	444
900044-59638	437	900588-55742	373	902-2007H	268	9024-9220	148	905-2004H	268	91-53321	444
900044-59639	437	900588-55745	373	902-2008H	268	9025-2120	147	905-2005H	268	91-53322	444
900044-510002	442	900588-55749	373	902-2009H	268	9025-2240	147	905-2006H	268	91-53323	444
900464-55450	422	900588-55760	372	902-2010H	268	9025-2250	147	905-2007H	268	91-54420	446
900464-55452	422	900588-55762	372	902-2011H	268	9025-2270	147	905-2008H	268	91-54421	446
900464-55455	422	900588-55765	372	902-2012H	268	9025-2280	147	905-2009H	268	91-54422	446
900464-55456	422	900588-55766	372	902-2013H	268	9025-9220	148	905-2010H	268	91-54423	446
900566-55450	422	900588-55770	372	902-2014H	268	9026-2120	147	905-2011H	268	91-55520	423
900566-55452	422	900588-55775	372	902-2015H	268	9026-2240	147	905-2012H	268	91-55522	423
900566-55455	422	900588-59420	371	902-2016H	268	9026-2250	147	905-2013H	268	91-55526	423
900566-55456	422	900588-59422	371	902-2017H	270	9026-2270	147	905-2014H	268	91-55750	373
900567-34146H	435	900588-59425	371	902-2018H	270	9026-2280	147	905-2015H	268	91-55752	373
900567-34147H	435	900588-59426	371	902-2019H	270	9026-2521	148	905-2016H	268	91-55755	373
900567-34148H	435	900588-59427	371	902-2020H	270	9026-2720	148	905-2017H	270	91-55759	373
900567-34149H	435	900588-59428	371	902-2021H	270	9026-2721	148	905-2018H	270	91-55840	378
900567-34156H	435	900588-59620	437	902-2022H	270	9026-4822	148	905-2019H	270	91-55841	378
900567-34157H	435	900588-59627	437	902-2023H	270	9026-9220	148	905-2020H	270	91-55845	378
900567-34158H	435	900588-59628	437	902-2024H	270	9027-2120	147	905-2021H	270	910-2001H	268
900567-34159H	435	900588-59629	437	902-2025H	270	9027-2240	147	905-2022H	270	910-2002H	268
900567-55720	372	900588-59630	437	902-2026H	270	9027-2250	147	905-2023H	270	910-2003H	268
900567-55722	372	900588-59637	437	902-2027H	270	9027-2270	147	905-2024H	270	910-2004H	268
900567-55725	372	900588-59638	437	902-2028H	270	9027-2280	147	905-2025H	270	910-2005H	268
900567-55729	372	900588-59639	437	902-2029H	270	9027-2521	148	905-2026H	270	910-2006H	268
900567-55730	371	900615-55450	422	902-2030H	270	9027-2720	148	905-2027H	270	910-2007H	268
900567-55732	371	900615-55452	422	902-2031H	270	9027-2721	148	905-2028H	270	910-2008H	268
900567-55735	371	900615-55455	422	902-2032H	270	9027-4822	148	905-2029H	270	910-2009H	268
900567-55736	371	900615-55456	422	902-2033H	270	9027-9220	148	905-2030H	270	910-2010H	268
900567-55737	371	900634-34136H	440	902-2034H	270	902R-1100	181	905-2031H	270	910-2011H	268
900567-55738	371	900634-34137H	440	902-2035H	270	902R-1110	181	905-2032H	270	910-2012H	268
900567-55740	373	900634-34138H	440	902-2036H	270	902R-1160	181	905-2033H	270	910-2013H	268
900567-55742	373	900634-34139H	440	902-2037H	270	902R-4030	181	905-2034H	270	910-2014H	268
900567-55745	373	900634-34166H	440	902-2038H	270	902R-4033	181	905-2035H	270	910-2015H	268
900567-55749	373	900634-34167H	440	902-2039H	270	902R-4034	181	905-2036H	270	910-2016H	268
900567-55760	372	900634-34168H	440	902-2040H	270	902R-4822	181	905-2037H	270	910-2017H	270
900567-55762	372	900634-34169H	440	902-2111H	268	902R-54420	446	905-2038H	270	910-2018H	270
900567-55765	372	900644-32059	442	902-2112H	268	902R-54421	446	905-2039H	270	910-2019H	270
900567-55766	372	900644-38119	442	902-2113H	268	902R-54422	446	905-2040H	270	910-2020H	270
900567-55770	372	900659-32059	442	902-2114H	268	902R-54423	446	905-2111H	268	910-2021H	270
900567-55775	372	900659-38119	442	902-2115H	268	9030-2120	147	905-2112H	268	910-2022H	270
900567-59420	371	900671-34136H	440	902-2116H	268	9030-2240	147	905-2113H	268	910-2023H	270
900567-59422	371	900671-34137H	440	902-2117H	268	9030-2250	147	905-2114H	268	910-2024H	270
900567-59425	371	900671-34138H	440	902-2118H	268	9030-2270	147	905-2115H	268	910-2025H	270
900567-59426	371	900671-34139H	440	902-2119H	268	9030-2280	147	905-2116H	268	910-2026H	270
900567-59427	371	900671-34166H	440	902-2120H	268	9030-2521	148	905-2117H	268	910-2027H	270
900567-59428	371	900671-34167H	440	9020-2120	147	9030-2720	148	905-2118H	268	910-2028H	270
900567-59620	437	900671-34168H	440	9020-2240	147	9030-2721	148	905-2119H	268	910-2029H	270
900567-59627	437	900671-34169H	440	9020-2250	147	9030-4822	148	905-2120H	268	910-2030H	270
900567-59628	437	900672-32059	442	9020-2270	147	9030-9220	148	91-34306	441	910-2031H	270
900567-59629	437	900672-38119	442	9020-2280	147	9031-2120	147	91-34307	441	910-2032H	270
900567-59630	437	900673-32059	442	9020-9220	148	9031-2240	147	91-34308	441	910-2033H	270
900567-59637	437	900673-38119	442	9021-2120	147	9031-2250	147	91-34309	441	910-2034H	270
900567-59638	437	900674-55450	422	9021-2240	147	9031-2270	147	91-37120	429	910-2035H	270
900567-59639	437	900674-55452	422	9021-2250	147	9031-2280	147	91-37121	429	910-2036H	270
900567-510002	442	900674-55455	422	9021-2270	147	9031-2521	148	91-37122	429	910-2037H	270
900568-34136H	440	900674-55456	422	9021-2280	147	9031-2720	148	91-37125	430	910-2038H	270
900568-34137H	440	900713-342555HK	290	9021-2521	148	9031-2721	148	91-37126	430	910-2039H	270
900568-34138H	440	900714-342555HK	290	9021-2720	148	9031-4822	148	91-37127	430	910-2040H	270
900568-34139H	440	900719-342555HK	290	9021-2721	148	9031-9220	148	91-37150	442	910-2111H	268
900568-34166H	440	900725-342555HK	290	9021-4822	148	9032-2120	147	91-37155	442	910-2112H	268
900568-34167H	440	900726-342555HK	290	9021-9220	148	9032-2240	147	91-37180	429	910-2113H	268
900568-34168H	440	901-37080	141, 361	9022-2120	147	9032-2250	147	91-37182	429	910-2114H	268
900568-34169H	440	901-37081	141, 361	9022-2240	147	9032-2270	147	91-37183	430	910-2115H	268
900588-34146H	435	901-37082	141, 361	9022-2250	147	9032-2280	147	91-37185	430	910-2116H	268
900588-34147H	435	901i-27180H	140, 360	9022-2270	147	9032-2521	148	91-37188	429	910-2117H	268
900588-34148H	435	901i-27181H	140, 360	9022-2280	147	9032-2720	148	91-37189	430	910-2118H	268
900588-34149H	435	901i-27182H	140, 360	9022-2521	148	9032-2721	148	91-53130	436	910-2119H	268

Article-No.	Page(s)	Article-No.	Page(s)	Article-No.	Page(s)
910-2120H	268	920-2036H	270	980-2039H	270
918-37080	141, 361	920-2037H	270	980-2111H	268
918-37081	141, 361	920-2038H	270	980-2118H	268
918-37082	141, 361	920-2039H	270	980-2120H	268
918i-27180H	140, 360	920-2040H	270	F-190	403
918i-27181H	140, 360	920-2111H	268	R10000	455
918i-27182H	140, 360	920-2112H	268	R10100	455
918i-32020H	138, 358	920-2113H	268	R12100	455
918i-32050H	138, 358	920-2114H	268	R20000	455
918i-32080H	139, 359	920-2115H	268	R20100	455
918i-32100H	139, 359	920-2116H	268	R21000	455
918i-34020H	141, 361	920-2117H	268	R21100	455
918i-34090H	139, 359	920-2118H	268	R40100	455
918i-34306H	141, 361	920-2119H	268	R50100	455
918i-38110H	138, 358	920-2120H	268	R51100	455
918i-42550HK	138, 358	926-37080	141, 361		
918i-42580HK	139, 359	926-37081	141, 361		
91i-32020H	127, 349	926-37082	141, 361		
91i-32025H	129, 351	926i-27180H	140, 360		
91i-32027H	129, 351	926i-27181H	140, 360		
91i-32050H	127, 349	926i-27182H	140, 360		
91i-32055H	129, 351	926i-32020H	138, 358		
91i-32057H	129, 351	926i-32050H	138, 358		
91i-34070H	441	926i-32080H	139, 359		
91i-34100H	434	926i-32100H	139, 359		
91i-34105H	434	926i-34020H	141, 361		
91i-34106H	434	926i-34090H	139, 359		
91i-34107H	434	926i-38110H	138, 358		
91i-34108H	434	926i-42550HK	138, 358		
91i-34109H	434	926i-42580HK	139, 359		
91i-34110H	434	929R-1100	181		
91i-34115H	434	929R-1110	181		
91i-34116H	434	929R-1160	181		
91i-34117H	434	929R-4030	181		
91i-34118H	434	929R-4033	181		
91i-34119H	434	929R-4034	181		
91i-34120H	441	929R-4822	181		
91i-34125H	441	948-1010	224		
91i-34126H	441	948-1630	224		
91i-34127H	441	948-4822	225		
91i-34128H	441	948-9066	225		
91i-38110H	127, 349	948-9330	226		
91i-38115H	129, 351	948-9335	226		
91i-38116H	129, 351	948-9337	226		
91i-38117H	129, 351	948-9338	226		
91i-38118H	129, 351	948-9570	225		
920-2001H	268	948-9573	225		
920-2002H	268	948-9574	225		
920-2003H	268	950-1010	224		
920-2004H	268	950-1110	181		
920-2005H	268	950-1630	224		
920-2006H	268	950-4030	181		
920-2007H	268	950-4033	181		
920-2008H	268	950-4034	181		
920-2009H	268	950-4822	225		
920-2010H	268	950-9066	225		
920-2011H	268	951-1100	224		
920-2012H	268	951-1620	224		
920-2013H	268	951-2110	147		
920-2014H	268	951-2120	147		
920-2015H	268	951-4822	225		
920-2016H	268	951-9066	225		
920-2017H	270	958-1010	224		
920-2018H	270	958-1630	224		
920-2019H	270	958-4822	225		
920-2020H	270	958-9066	225		
920-2021H	270	958-9330	226		
920-2022H	270	958-9335	226		
920-2023H	270	958-9337	226		
920-2024H	270	958-9338	226		
920-2025H	270	964-1100	181		
920-2026H	270	964-1110	181		
920-2027H	270	964-1160	181		
920-2028H	270	980-2003H	268		
920-2029H	270	980-2007H	268		
920-2030H	270	980-2011H	268		
920-2031H	270	980-2015H	268		
920-2032H	270	980-2019H	270		
920-2033H	270	980-2023H	270		
920-2034H	270	980-2027H	270		
920-2035H	270	980-2031H	270		

692 INDEX ACCORDING TO MODELS

Model	Series	Page(s)	
1x1 cm / 3/8 x 3/8 Inch	Marble & More	219	
	Plural	257, 259	
ø 1 cm / 3/8 Inch	Loop	213	
1x20 cm / 3/8 x 8 Inch	Basis 1	94, 486	
2.5 x 2.5 cm / 1 x 1 Inch	Amano	43	
	Fresh	192-194	
	Jasba-Pattern	530	
	Jasba-Ronda	538	
	Jasba-Senja Pure	542, 543	
	Karl	201	
	Marble & More	219	
	Plural	257, 259	
	Plural non-slip	268, 270	
	Plural unglazed	276	
	ø 2 cm / 6/8 Inch	Loop	213, 214
	3.7 x 40 cm / 2 x 16 Inch	La Casa	567
3.7 x 60 cm / 2 x 24 Inch	La Casa	567	
4 x 60 cm / 1 5/8 x 24 Inch	Area Pro	67	
	Como	503	
	Mandalay	592	
4.5 x 20 cm / 1 13/16 x 8 Inch	Basis 1	94, 486	
5 x 5 cm / 2 x 2 Inch	Alcina	470	
	Area Pro	60	
	Ascona	79	
	Basic Stone	89	
	Basis 3	97	
	Basis Pro	104	
	Cedra	499	
	Evalia	516	
	Fresh	194	
	Jasba-Pattern	530	
	Jasba-Ronda	538, 539	
	Jasba-Senja Pure	530	
	Jasba-Village	548, 549	
	Kiano	558, 561	
	Like	573	
	Lounge	585	
	Nova	239	
	Plural	257, 259	
	Plural non-slip	268, 270	
	Plural unglazed	276	
	Quarzit	289	
	Savona	296	
	Sento	624	
	Sierra	630	
	Solid Rock	644	
	Soul	650	
	Stories	660	
Trias	316		
Unique	322		
Valley	328		
5 x 10 cm / 2 x 4 Inch	District	157	
5 x 60 cm / 2 x 24 Inch	Solid Rock	638	
	Unique	322	
	Valley	328	
5 x 90 cm / 2 x 36 Inch	Sky	635	
6 x 50 cm / 2 3/8 x 20 Inch	Ascona	81	
	Quarzit	290	
6 x 60 cm / 2 3/8 x 24 Inch	Ascona	81	
	Oak	611	
	Quarzit	290	
	Savona	296	
	Streetlife	302	
	Walden	674	
6.2 x 25 cm / 2 1/2 x 10 Inch	Chroma	120-123, 344-347	
	Chroma unglazed	141, 361	
	Craft	147, 148	
6.2 x 50 cm / 2 1/2 x 20 Inch	Craft extended	153	
7 x 20 cm / 2 13/16 x 8 Inch	Basis 3	98	
7 x 30 cm / 2 13/16 x 12 Inch	Area Pro	67	
	Basis 3	98	

Model	Series	Page(s)
7 x 60 cm / 2 13/16 x 24 Inch	Alcina	469
	Area Pro	67
	Aruba	478
	Basis Pro	106
	Cedra	499
	Emotion	169
	Evalia	516
	Kiano	560
	Like	577
	Lounge	585
	Nova	242
	Sento	623
	Sierra	629
	Solid Rock	643
	Soul	649
	Stories	659
	Timeless	667
	Trias	316
	Unique	323
Urban Cotto	671	
Valley	329	
7.2 x 60 cm / 2 7/8 x 24 Inch	Area Pro	67
7.2 x 120 cm / 2 7/8 x 48 Inch	Area Pro	67
7.2 x 135 cm / 2 7/8 x 53 Inch	Area Pro	67
7.5 x 25 cm / 3 1/8 x 10 Inch	Aruba	475
7.5 x 30 cm / 3 1/8 x 12 Inch	Lunar	588, 589
7.9 x 25 cm / 3 1/8 x 10 Inch	Chroma unglazed	414, 361
8 x 60 cm / 3 3/16 x 24 Inch	Concrete	508
8.3 x 25 cm / 3 5/16 x 10 Inch	Craft	147
	Natural Ceramics	225
8.3 x 30 cm / 33/8 x 12 Inch	Natural Ceramics	225
8.45 x 33 cm / 3 13/32 x 13 13/64 Inch	Mando	596
10 x 10 cm / 4 x 4 Inch	Area Pro	60, 64, 65
	Basis 2	96
	Basis 3	97, 98
	Emotion	176
	Jasba-Clara	526
	Jasba-Pattern	531
	Karl	201
	Plural	257, 259, 261, 262
	Plural non-slip	268-271
	Plural unglazed	276, 277
	10 x 15 cm / 4 x 6 Inch	Basis 3
10 x 20 cm / 4 x 8 Inch	Area Pro	64
	Basis 3	98
	Emotion	170
	Emotion Grip	177
	Plural	250, 252
10 x 25 cm / 4 x 10 Inch	Ascona	84
	District	157
	Karl	201
	Kiano	558
10 x 30 cm / 4 x 12 Inch	Area Pro	64
	Basis Pro	106
	Emotion	170
	Plural	250, 252, 257, 259
10 x 40 cm / 4 x 16 Inch	Plural	250, 252
10 x 50 cm / 4 x 20 Inch	Ascona	81
10 x 60 cm / 4 x 24 Inch	Area Pro	62, 64
	Ascona	81
	Basis Pro	104
	Cedra	495
	Emotion	168
	Modern White	603
	Nova	239, 242
	Plural	250
	Quarzit	290
	Solid Rock	638
	Unique	322
Valley	328	





Model	Series	Page(s)	
10 x 90 cm / 4 x 36 Inch	Cedra	496	
	Modern White	603	
	Sky	635	
12.5 x 3.3 cm / 5 x 1 3/8 Inch	Special Tiles	443	
12.5 x 6.2 cm / 5 x 2 1/2 Inch	Special Tiles	441	
12.5 x 12.5 cm / 5 x 5 Inch	Ascona	82	
	Pool Edge System Finland II	378	
	Chroma	120-123, 344-347	
	Chroma non-slip	127-129, 131, 132, 349-351, 353, 354	
	Chroma unglazed	138-140, 358-360	
	Quarzit	289	
	Grooved Tiles	434-437	
	Special Tiles	440, 442, 443	
	12.5 x 15.6 cm / 5 x 6 1/4 Inch	Grooved Tiles	434-437
		Special Tiles	440
12.5 x 25 cm / 5 x 10 Inch	Area Pro	69, 378	
	Ascona	82, 83, 379	
	Chroma	120-123, 344-347	
	Chroma non-slip	127-129, 131, 132, 349-351, 353, 354	
	Chroma unglazed	138-141, 358-360	
12.5 x 30 cm / 5 x 12 Inch	Craft	147, 148	
	Natural Ceramics	224-226	
	Quarzit	289, 291, 379	
	Special Tiles	442	
12.5 x 50 cm / 5 x 20 Inch	Natural Ceramics	225	
12.5 x 100 cm / 5 x 40 Inch	Chroma	120-123, 344-346	
	Plural	257, 259	
15 x 15 cm / 6 x 6 Inch	Area Pro	61	
	Ascona	79	
	Basis 1	93, 482	
	Basis 2	96	
	Basis 3	97	
	Basis Pro	104	
	Emotion	170	
	Jasba-Clara	527	
	Natural Ceramics	224	
	Nova	239	
	Plural	250, 252, 258, 260	
	Plural unglazed	276	
	Quarzit	289	
	Savona	296	
Valley	328		
15 x 30 cm / 6 x 12 Inch	Basis 1	93, 482	
	Natural Ceramics	224	
	Plural	250, 252	
15 x 60 cm / 6 x 24 Inch	Area Pro	62	
	Basis Pro	104	
	Emotion	168, 170	
	Nova	239	
	Pizarro	614	
	Solid Rock	639, 642	
	Unique	322	
Valley	328		
15 x 90 cm / 6 x 36 Inch	Oak	608	
15.4 x 15.4 cm / 6 3/16 x 6 3/16 Inch	Orientation Aids for the Blind	113	
20 x 7.9 cm / 8 x 3 1/8 Inch	Skirtings Profiled edgings	428	
20 x 10 cm / 8 x 4 Inch	Skirtings Profiled edgings	428	
20 x 20 cm / 8 x 8 Inch	Area Pro	61	
	Basis 1	93, 482	
	Basis 2	96	
	Basis 3	97	
	Emotion	168	
	Emotion Grip	176, 177	
	Jasba-Pattern	532-535	
	Plural	251, 253, 258, 260	
	Plural Kids	282	
	Plural non-slip	268, 270	
	Plural unglazed	277	

Model	Series	Page(s)	Model	Series	Page(s)	Model	Series	Page(s)		
20 x 25 cm	/ 8 x 10 Inch		Emotion Grip		176, 177	35 x 100 cm	/ 14 x 40 Inch			
	Basis 1	93, 483	Focus Royal		521		Basis 1	94, 486		
20 x 40 cm	/ 8 x 16 Inch		Kiano		557		Basis 1+	95		
	Basis 1	93, 482, 483	La Casa		567		Bliss	490, 491		
	La Casa	564	New Market		233		Kiano	556		
	Plural	251, 253, 258, 260	Plural		258, 260		Mando	596-598		
20 x 60 cm	/ 8 x 24 Inch		Quarzit		453		Sento	618, 619		
	Basis 1	93, 483	Sento		620		Stories	654, 655		
	Basis 1+	95	Sierra		630	40 x 60 cm	/ 16 x 24 Inch			
	Jasba-Senja Pure	545	Stories		656		Area Pro	311		
	La Casa	564	Timeless		665		Surf	311		
	Plural	251, 252	Unique		322	40 x 120 cm	/ 16 x 48 Inch			
	Unique	322	Valley		328, 453		Oak	609		
	Valley	328					Walden	675		
20 x 120 cm	/ 8 x 48 Inch		30 x 35 cm	/ 12 x 14 Inch		45 x 80 cm	/ 18 x 53 Inch			
	Walden	674		Oak	611		Area Pro	311		
24 x 12.5 cm	/ 10 x 5 Inch		30 x 44.5 cm	/ 12 x 18 Inch			Surf	311		
	Basis 4	99		Like	574	45 x 90 cm	/ 18 x 36 Inch			
24.3 x 43.8 cm	/ 10 x 18 Inch		30 x 45 cm	/ 12 x 18 Inch			Alcina	466		
	Alcina	463		Basis 1+	95		Cedra	498		
25 x 12.5 cm	/ 10 x 5 Inch		30 x 60 cm	/ 12 x 24 Inch			Evalia	515		
	Basis 4	99		Alcina	462, 464	50 x 25 cm	/ 20 x 10 Inch			
25 x 3.3 cm	/ 10 x 1 3/8 Inch			Area Pro	60, 62, 66, 71		Area Pro	69, 378, 444		
	Special Tiles	443		Aruba	474-476, 478		Ascona	83, 84, 379, 445		
25 x 6.2 cm	/ 10 x 2 1/2 Inch			Ascona	79		Pool Edge System Finland II	378		
	Skirtings Profiled edgings	428		Basis 1	94, 485	50 x 100 cm	/ 20 x 40 Inch			
	Special Tiles	441		Basis 1+	95		Ascona	85		
25 x 6.6 cm	/ 10 x 2 5/8 Inch			Basis 2	96		Plural	258, 260		
	Skirtings Profiled edgings	428		Basis 3	98	55 x 120 cm	/ 22 x 48 Inch			
25 x 7.9 cm	/ 10 x 3 1/8 Inch			Basis Pro	105, 106, 233		Area Pro	311		
	Skirtings Profiled edgings	428		Cedra	494, 497	60 x 60 cm	/ 24 x 24 Inch			
25 x 8.9 cm	/ 10 x 3 1/2 Inch			Como	502		Alcina	465, 468		
	Eladuct + KerAion Ela 10.6	161		Concrete	506, 507		Area Pro	63, 70, 71, 233		
25 x 12.5 cm	/ 10 x 5 Inch			Emotion	168, 169		Aruba	476		
	Basis 4	99		Evlia	512, 513		Ascona	80		
	Eladuct + KerAion Ela 10.6	161		Focus Royal	520		Basis Pro	105, 233		
	Ferrum	181		Jasba-Nivella	550		Cedra	497		
	Skirtings Profiled edgings	428		Jasba-Senja Pure	545		Eladuct + KerAion Ela 10.6	161		
	Grooved Tiles	434-437		Kiano	556, 559, 560		Emotion	169		
	Special Tiles	440-443		La Casa	565, 566		Evalia	515		
25 x 15.6 cm	/ 10 x 6 1/4 Inch			Like	570, 577		KerAion OP Special Glazes	205		
	Grooved Tiles	434-437		Lounge	580-582		Kiano	559		
	Special Tiles	440, 441, 446		Lunar	588		Like	570, 575		
25 x 25 cm	/ 10 x 10 Inch			Mandalay	592		Lounge	582		
	Area Pro	69, 378		Modern White	602, 604		New Market	233		
	Ascona	82, 83, 379		New Market	233		Nova	240, 241		
	Pool Edge System Finland II	378		Nova	240, 241		Pizarro	614		
	Chroma	120-123, 344-347		Plural	251, 253, 258, 260		Plural	251, 253, 258, 260		
	Chroma non-slip	127-129, 131, 132,		Plural non-slip	268, 270		Plural unglazed	277		
		350, 351, 353, 354		Quarzit	289		Savona	296		
	Chroma unglazed	138, 139, 358, 359		Sento	618, 619, 621		Sento	621, 623		
	Natural Ceramics	224		Sierra	628, 629		Solid Rock	639, 641		
	Quarzit	389, 291, 379		Solid Rock	639, 643		Soul	648		
	Special Tiles	442		Soul	648, 649		Stories	657, 660		
25 x 30 cm	/ 10 x 12 Inch			Stories	654, 655, 657, 659		Streetlife	302		
	Pool Edging Tiles	423		Timeless	660, 664		Timeless	660		
	Craft	148		Trias	316		Trias	316		
	Natural Ceramics	225		Unique	322, 323		Unique	323		
25 x 33 cm	/ 10 x 13 Inch			Valley	328, 329		Urban Cotto	670		
	Basis 1	94, 484					Valley	328, 329		
25 x 35 cm	/ 10 x 14 Inch		30 x 90 cm	/ 12 x 36 Inch		60 x 90 cm	/ 24 x 36 Inch			
	Natural Ceramics	226		Alcina	462		Area Pro	63		
25 x 44 cm	/ 10 x 17 5/8 Inch			Area Pro	60		Ascona	85		
	Basis 1+	95		Aruba	474, 475		Streetlife	302		
25 x 50 cm	/ 10 x 20 Inch			Basis 1	94, 486	60 x 120 cm	/ 24 x 48 Inch			
	Ascona	79, 81, 83		Basis 1+	95		Area Pro	63, 66, 311		
	Chroma	120-123, 344-346		Cedra	494		Aruba	477		
	Chroma unglazed	138, 139, 358, 359		Evalia	512, 514		Lounge	583		
	Plural	258, 260		Focus Royal	520, 522		Nova	241		
	Quarzit	289-291, 445, 453		Jasba-Senja Pure	545		Oak	610		
	Special Tiles	444		Lounge	580, 581		Savona	296		
	Valley	453		Lunar	589		Sento	622		
27,8 x 20 cm	/ 11 x 8 Inch			Modern White	602, 605		Solid Rock	640, 641		
	Emotion Grip	177		Oak	608		Streetlife	302		
28 x 135 cm	/ 11 x 55 5/32 Inch			Sky	634		Surf	311		
	Area Pro	66					Timeless	667		
	Ascona	80		30 x 120 cm	/ 12 x 48 Inch		Unique	323		
	Nova	241			Oak	609, 610	Valley	328		
	Quarzit	290			Streetlife	302				
30 x 7.9 cm	/ 12 x 3 1/8 Inch			31 x 30 cm	/ 12 13/64 x 12 Inch		80 x 80 cm	/ 32 x 32 Inch		
	Skirtings Profiled edgings	428			Craft extended	153		Like	571	
30 x 8.7 cm	/ 12 x 3 1/2 Inch			31 x 135 cm	/ 12 13/64 x 53 Inch		90 x 90 cm	/ 36 x 36 Inch		
	Eladuct + KerAion Ela 10.6	161			Area Pro	66		Alcina	467	
30 x 30 cm	/ 12 x 12 Inch				Ascona	80		Area Pro	64	
	Area Pro	62, 66, 68			Nova	241	100 x 100 cm	/ 40 x 40 Inch		
	Basis 3	97, 98			Quarzit	290		Stories	658	
	Basis Pro	104, 233			35 x 35 cm	/ 14 x 14 Inch		120 x 120 cm	/ 48 x 48 Inch	
	Orientation Aids for the Blind	111				Natural Ceramics	226		Like	572, 576
	Emotion	168, 233							Lounge	574
									Nova	241

694 MODEL NUMBERS (porcelain stoneware, stoneware and split tiles)

Model No.	Page(s)	Model No.	Page(s)	Model No.	Page(s)	Model No.	Page(s)	Model No.	Page(s)
703	257, 259	37018	443	55187	383, 387	59629	437	32100H	139, 359
730	258, 260	37021	428	55188	383, 387	59630	437	332050HK	289
760	258, 260	37023	428	55440	422	59637	437	34020H	141, 361
1010	224	37024	428	55442	422	59638	437	34070H	441
1020	224	37031	443	55445	422	59639	437	34090H	139, 289, 359
1030	224	37035	443	55446	422	59680	443	34120H	441
1100	181, 161	37040	161	55450	422	59681	443	34125H	441
1160	181	37042	161	55452	422	59685	443	34126H	441
1620	224	37043	161	55455	422	85160	383	34127H	441
1630	224	37044	161	55456	422	85161	383	34128H	441
2110	147	37080	141, 361, 428	55460	423	85163	383	34136H	440
2120	147	37081	141, 361, 428	55462	423	85165	383	34137H	440
2240	147	37082	141, 361, 428	55465	423	85166	383	34138H	440
2250	147	37088	427	55466	423	85167	383, 387	34139H	440
2270	147	37090	428	55520	423	85168	383, 387	34146H	435
2280	147	37091	428	55522	423	85180	385	34147H	435
2290	153	37092	428	55526	423	85181	385	34148H	435
2320	153	37120	429	55561	441, 442	85183	385	34149H	435
2521	148	37121	429	55562	441, 442	85185	385	341550HK	257, 259
2541	226	37122	429	55563	442	85186	385	34156H	435
2720	148	37125	430	55565	442	85187	385	34157H	435
2721	148	37126	430	55566	442	85188	385	34158H	435
4000	161	37127	430	55567	442	85190	385	34159H	435
4003	161	37150	442	55720	372	85191	385	34166H	440
4004	161	37155	442	55722	372	85193	385	34167H	440
4030	181	37180	429	55725	372	85195	385	34168H	440
4033	181	37182	429	55729	372	85196	385	34169H	440
4034	181	37183	430	55730	371	85197	385	34170H	441
4822	148, 181, 225	37185	430	55732	371	85198	385	342030H	289, 296
4825	225	37186	427	55735	371	86160	403	342550HK	258, 260, 289
6635	113	37188	429	55736	371	86161	403	342555HK	290
6636	113	37189	430	55737	371	86162	403	342557HK	290
8110	99	38110	99	55738	371	86163	403	342580HK	289
9063	225	38119	442	55740	373	86165	403	34306H	141, 361
9066	225	44025	428	55742	373	86167	403	352010HK	257, 259
9215	153	44026	428	55745	373	86168	403	352050HK	258, 260
9220	148	53130	436	55749	373	87160	391	38110H	127, 128, 131, 138, 289, 349, 350, 353, 358
9330	226	53135	436	55750	373	87161	391	38115H	129, 132, 351, 354
9335	226	53136	436	55752	373	87163	391	38115H	129, 132, 351, 354
9337	226	53137	436	55755	373	87165	391	38116H	129, 132, 351, 354
9338	226	53138	436	55759	373	87166	391	38117H	129, 132, 351, 354
9570	225	53139	436	55760	372	87167	391	38118H	129, 132, 351, 354
9573	225	53150	69, 83, 291, 378, 379	55762	372	87168	391	41550HK	120, 122, 123, 344, 345, 346
9574	225	53151	69, 83, 291, 378, 379	55765	372	95160	387	42550HK	120, 122, 123, 138, 344, 345, 346
9822	226	53159	69, 83, 291, 378, 379	55766	372	95161	387	42550HK	120, 122, 123, 138, 344, 345, 346
17112	427	53190	436	55770	372	95163	387	42580HK	139, 359
17190	427	53195	436	55775	372	95165	387	53510H	453
17191	427	53196	436	55800	423	95166	387	53511H	453
17193	427	53197	436	55802	423	95180	387	53512H	453
17194	427	53198	436	55805	423	95181	387	61061HK	291
17196	427	53199	436	55806	423	95183	387	7161H	289, 296
18120	99	53320	69, 84, 291, 444, 445	55820	377	95185	387	B200HK	289, 296
18190	427	53321	69, 84, 291, 444, 445	55821	377	95186	387	B600HK	205, 289, 296
18191	427	53322	69, 84, 291, 444, 445	55822	377	12020H	120, 122, 123, 344, 345, 346	B611HK	290, 296
18192	427	53323	69, 84, 291, 444, 445	55825	377		121, 347	B612HK	290
18193	427	53510	453	55826	377	12023H	120, 122, 123, 344, 345, 346	B700HK	302
18194	427	53511	453	55830	377	12050H	121, 347	B710HK	302
18196	427	53512	453	55831	377		120, 122, 123, 344, 345, 346	B729HK	302
32059	442	54420	446	55832	377	12053H	120, 122, 123, 344, 345, 346	B755HK	302
34020	428	54421	446	55835	377	18120H	121, 347	B770HK	302
34100	434	54422	446	55836	377		121, 347	B775HK	290
34105	434	54423	446	55840	378	18123H	120, 122, 123, 344, 345, 346	B776HK	290
34106	434	55100	395	55841	378	18124H	120, 122, 123, 344, 345, 346	K100	161
34107	434	55101	395	55845	378	18210H	121, 347	S10002	442
34108	434	55105	395	55850	403		121, 347	S50044	383
34109	434	55106	395	55852	403	18213H	140, 360	S50065	395
34110	434	55107	395	55855	403	18214H	140, 360	S55102	395
34115	434	55108	395	55856	403	27180H	140, 360	S55142	395
34116	434	55140	395	55857	403	27181H	127, 128, 131, 138, 289, 349, 350, 353, 358	S55182	383
34117	434	55141	395	55858	403	27182H	129, 132, 351, 354	S85162	383
34118	434	55143	395	59420	371	32020H	129, 132, 351, 354	S85182	385
34119	434	55145	395	59422	371		129, 132, 351, 354	S85192	385
34306	441	55146	395	59425	371	32025H	127, 128, 131, 138, 349, 350, 353, 358	S95162	387
34307	441	55147	395	59426	371	32027H	129, 132, 351, 354	S95182	387
34308	441	55148	395	59427	371	32050H	129, 132, 351, 354	S95182	387
34309	441	55180	383	59428	371		129, 132, 351, 354		
37011	443	55181	383	59620	437	32055H	129, 132, 351, 354		
37015	443	55185	383	59627	437	32057H	129, 132, 351, 354		
37017	443	55186	383	59628	437	32080H	139, 359		

Agrob Buchtal offers tiles with overglazed edges in many series. In the case of glazed **earthenware tiles**, they are included in the bundles at a certain quantity as overglazed edges are almost always required for applications of these materials. In the case of **split tiles**, overglazed or overglazed *rounded* edges are available upon request according to the following model number system:

					
Last figure 0 of model no.	...1 = Short edge	...2 = Longitudinal edge	...3 = Corner left	...4 = Corner right	overglazed edges
to be replaced by5 = Short edge	...6 = Longitudinal edge	...7 = Corner left	...8 = Corner right	overglazed rounded edges (bullnoses)

Example: Standard model no. 18120 = 244 x 119 x 6 mm,
 model no. 18123 = overglazed corner left

Area Pro

Color	similar to NCS no.	similar to RAL no.	Color Shade Variation
anthracite	S7502-B	7024	V2
basalt	S7005-B80G	180 4005	V2
pebble	S3502-Y	7030	V2
stone	S2502-Y	100 7005	V2
sand-white	S1502-Y50R	080 8005	V2
sand-grey	S1502-Y50R	080 7005	V2
sand	S5005-Y20R	075 5010	V2
nutmeg	S7005-Y50R	060 4005	V2
platinum	S0500-N	8500	V2
sand-beige	S1005-Y50R	060 8010	V2
brick	S7010-Y30R	060 4010	V2
clay	S8010-Y50R	050 3010	V2

ChromaPlural
Chroma non-slip
Chroma unglazed

Color	similar to NCS no.	similar to RAL no.	Lightness Value Y
neutral 1 (Chroma unglazed)	S9000-N	9017	3
neutral 1	8000	7016	6
neutral 2	S7500-N	7015	9
neutral 3	S6500-N		15
neutral 4	S6000-N	7037	18
neutral 5	S5502-B	7046	21
neutral 6	S4502-B	7045	25
neutral 7	S4000-N	7004	33
neutral 8	S2502-B		46
neutral 9	S1502-R50B		65
neutral 10 (ChromaPlural)	S1000-N	9003	76
neutral 10 (Chroma unglazed)	0502-Y	9001	66
neutral 10 (white glossy)	S1500	9003	70
active azure	S5030-R80B	5000	9
light azure	S2030-R80B		37
medium azure	S4030-R90B		21
dark azure	S4040-R90B	5007	13
active blue	S6030-R90B		7
light blue	S1510-R80B		60
medium blue	S2020-R80B		40
dark blue	S4030-R80B		17
active turquoise	S4030-B50G	6033	22
light turquoise	S1010-B50G		63
medium turquoise	S2020-B30G		44
dark turquoise	S4020-B30G		26
active green	S3050-G50Y		26
light green	S0510-G		69
medium green	S1515-G20Y	6019	53
dark green	S3020-G10Y	6021	31
active yellow	S3050-Y10R		32
light yellow	S1010-Y10R	1015	69
medium yellow	S2030-Y10R		50
dark yellow	S2050-Y20R		33
active ochre	S3050-Y40R		20
light ochre	S2030-Y20R		48
medium ochre	S3030-Y30R		36
dark ochre	S4030-Y50R		21
active salmon	S4040-Y70R		15
light salmon	S1515-Y50R		51
medium salmon	S2020-Y50R		39
dark salmon	S3040-Y60R		23
active oxide red	S4050-Y90R		10
light oxide red	S2010-Y80R		46
medium oxide red	S3020-Y80R		25
dark oxide red	S5020-Y80R		15
active stone grey	S5030-Y90R		9
light stone grey	S2502-R		46
medium stone grey	S3502-R	7036	34
dark stone grey	S6005-Y80R		15
active sand grey	S7010-Y90R		8
light sand grey	S1502-Y		56
medium sand grey	S3005-Y50R		35
dark sand grey	S6010-Y50R		14

Special colors

Color	similar to NCS no.	similar to RAL no.	Lightness Value Y
apple-green	S1060-G40Y		39
medium brown	S5020-Y50R	060 50 20	17
medium grey	S3502-Y	100 70 05	32
intense blue	6040-R70B		1
contrasting red (Chroma non-slip B)	S2050-Y90R	3017	14
contrasting red (Chroma non-slip C)	S2060-Y90R	3018	15
contrasting red (Chroma)	S2570-Y90R	3002	10
natural-white	2005-Y20R	7032	51
orange	S2060-Y50R	2010	24
medium sand	S1010-Y20R	1001	44
deep anthracite	S6010-R90B	260 40 05	8
deep blue	S4050-R70B	290 30 35	8
deep yellow	S0560-Y	085 80 70	52
deeo green	S6020-G30Y	140 40 20	11
deep orange	S2060-Y60R	040 50 50	24
deep red	S1080R	030 40 50	11
violett	S5020-R50B	4001	13
lemon-yellow	1070-Y	1016	52

KerAion Special Glazes for Operation Theatres

Color	similar to NCS no.	similar to RAL no.	Lightness Value Y
beige	0502-Y	1013	69
blue	0530-R90B		46
grey	3000-N	7038	47
green	2030-B70G	6027	36
light-grey	1502-G50Y	7047	58
white	0500-N	9003	78

The use of color as an architectural design means has gained increasing importance during the last years. Therefore, we provide you with a list of the relevant Agrob Buchtal design series in order to facilitate planning. It classifies the colors according to:

NCS = Natural Color System

(More detailed information can be obtained from: Skandinavian Color Institute AB, P.O.Box 49022 · S-10028 Stockholm · Phone +46/8/6174700 · Fax +46/8/6174747, Institut für Farbe – Brigitte Hartmann · Rotes Knie 6 · 74389 Cleebrohn Phone 07135/12742 · Fax 07135/12737)

RAL Color Chart

(More detailed information can be obtained from: RAL - Deutsches Institut für Gütesicherung und Kennzeichnung e.V. · Siegburger Straße 39 · D-53757 St. Augustin Phone +49 (0) 2241/1605-0 · Fax +49 (0) 2241/1605-11)

Lightness Value:

This figure (standard color value Y) describes the lightness of a color in comparison with an ideally white surface if illuminated under identical light conditions, i. e. same intensity, direction and quality. For an ideal white, which means that all the incident light is reflected, the value Y = 100 applies (black: Y = 0).

Please note that these classifications may only serve as an orientation aid. Original samples will be made available to you upon request.

The difference in lightness of two adjoining colored surfaces is called luminance contrast. By means of this value, one can determine whether a room design is rich in contrast, as it is required, for example, by DIN 32975 "Designing visual information in the public area for accessible use". In the following, you will find the relevant values for selected

series. They result from the respective lightness values, which are indicated as averaged values of individual measurements. We will be pleased to determine values for other products upon request.

Luminance contrast Series Area Pro										
		anthracite	basalt	pebble	stone	sand-white	sand-grey	sand	nutmeg	
<i>Lightness Value Y</i>		8	13	21	33	50	38	21	14	
anthracite	8	0.00	0.23	0.44	0.60	0.72	0.64	0.44	0.24	
basalt	13		0.00	0.23	0.43	0.59	0.49	0.24	0.01	
pebble	21			0.00	0.22	0.41	0.29	0.01	0.22	
stone	33				0.00	0.21	0.08	0.21	0.42	
sand-white	50					0.00	0.14	0.40	0.58	
sand-grey	38						0.00	0.28	0.48	
sand	21							0.00	0.23	
nutmeg	14								0.00	
platinum	58									
sand-beige	41									
brick	14									
clay	10									

Luminance contrast Series Ascona							
		shell	sand	pearl	stone	mud	graphite
<i>Lightness Value Y</i>		55	50	47	40	27	11
shell	55	0.00					
sand	50	0.05	0.00				
pearl	47	0.08	0.03	0.00			
stone	40	0.16	0.11	0.08	0.00		
mud	27	0.34	0.30	0.27	0.19	0.00	
graphite	11	0.67	0.64	0.62	0.57	0.42	0.00

Luminance contrast Series Basis Pro						
		anthracite	basalt	ash-brown	concrete-grey	sand-beige
<i>Lightness Value Y</i>		7	10	20	24	42
anthracite	7	0.00				
basalt	10	0.14	0.00			
ash-brown	20	0.42	0.26	0.00		
concrete-grey	24	0.49	0.33	0.07	0.00	
sand-beige	42	0.66	0.53	0.29	0.22	0.00

Luminance contrast Series Area Pro (continuation)

		platinum	sand-beige	brick	clay
<i>Lightness Value Y</i>		58	41	14	10
anthracite	8	0.75	0.66	0.25	0.07
basalt	13	0.63	0.51	0.03	0.16
pebble	21	0.47	0.32	0.21	0.38
stone	33	0.28	0.11	0.41	0.55
sand-white	50	0.07	0.11	0.57	0.68
sand-grey	38	0.21	0.04	0.47	0.60
sand	21	0.46	0.31	0.21	0.38
nutmeg	14	0.62	0.50	0.01	0.17
platinum	58	0.00	0.18	0.62	0.72
sand-beige	41		0.00	0.49	0.62
brick	14			0.00	0.19
clay	10				0.00

Luminance contrast Series Emotion (Floor)

		deep anthracite	basalt	mid-grey	light-beige
<i>Lightness Value Y</i>		7	19	32	46
deep anthracite	7	0.00			
basalt	19	0.46	0.00		
mid-grey	32	0.64	0.25	0.00	
light-beige	46	0.74	0.42	0.18	0.00

Luminance contrast Series Nova

		cream-beige	mid-brown	mid-grey	basalt	anthracite	creme-beige-multicolored	mid-grey-multicolored	anthracite-multicolored
<i>Lightness Value Y</i>		44	18	35	15	6	44	35	9
cream-beige	44	0.00	0.42	0.11	0.49	0.76	0.00	0.11	0.66
mid-brown	18		0.00	0.32	0.09	0.50	0.42	0.32	0.33
mid-grey	35			0.00	0.40	0.71	0.11	0.00	0.59
basalt	15				0.00	0.43	0.49	0.40	0.25
anthracite	6					0.00	0.76	0.71	0.20
creme-beige-multicolored	44						0.00	0.11	0.66
mid-grey-multicolored	35							0.00	0.59
anthracite-multicolored	9								0.00

Luminance contrast Series Quarzit						
		basalt-grey	quarz-grey	sand-beige	sepia-brown	white-grey
<i>Lightness Value Y</i>		15	40	47	30	55
basalt-grey	15	0.00				
quarz-grey	40	0.45	0.00		0.14	
sand-beige	47	0.52	0.08	0.00	0.22	
sepia-brown	30	0.33			0.00	
white-grey	55	0.57	0.16	0.08	0.29	0.00

Luminance contrast Series Savona						
		chalk	beige	brown	grey	anthracite
<i>Lightness Value Y</i>		52	38	20	20	8
chalk	52	0.00	0.16	0.44	0.44	0.73
beige	38		0.00	0.31	0.31	0.65
brown	20			0.00	0.00	0.43
grey	20			0.00	0.00	0.43
anthracite	8					0.00

Luminance contrast Series Unique							
		anthracite	basalt	light-grey	beige	brown	mud
<i>Lightness Value Y</i>		6	17	36	45	18	30
anthracite	6	0.00					
basalt	17	0.48	0.00				
light-grey	36	0.71	0.36	0.00		0.33	0.09
beige	45	0.76	0.45	0.11	0.00	0.43	0.20
brown	18	0.50	0.03			0.00	
mud	30	0.67	0.28			0.25	0.00

Luminance contrast Series Valley					
		slate	pebble-grey	earth-brown	sand-beige
<i>Lightness Value Y</i>		9	33	10	51
slate	9	0.00			
pebble-grey	33	0.57	0.00	0.53	
earth-brown	10	0.05		0.00	
sand-beige	51	0.70	0.21	0.67	0.00

European Quality Standards

Product Standards (simplified and based on 20 x 20 cm (BIII), or 30 x 30 cm (BI))	Extruded Ceramic Tiles DIN EN 14411		Dry-pressed Ceramic Tiles DIN EN 14411		Test Standards
	group AI _a + AI _b „Nature“ „Precision“	group AII _a - Teil 1 „Nature“ „Precision“	group BI _a + BI _b	group BIII	
A) Dimensions + Surfaces					
1. Length and Width	± 2% ± 1.0%	± 2% ± 1.25%	± 0.6%	± 0.5%	DIN EN ISO 10545-2
2. Thickness	± 10% ± 10%	± 10% ± 10%	± 5%	± 10%	DIN EN ISO 10545-2
3. Straightness of Edges	± 0.6% ± 0.5%	± 0.6% ± 0.5%	± 0.5%	± 0.3%	DIN EN ISO 10545-2
4. Rectangularity	± 1.0% ± 1.0%	± 1.0% ± 1.0%	± 0.5%	± 0.5%	DIN EN ISO 10545-2
5. Surface Flatness					DIN EN ISO 10545-2
5.1 Curvature at Centre	± 1.5% ± 0.5%	± 1.5% ± 0.5%	± 0.5%	+ 0.5/-0.3%	DIN EN ISO 10545-2
5.2 Curvature at the Edges	± 1.5% ± 0.5%	± 1.5% ± 0.5%	± 0.5%	+ 0.5/-0.3%	DIN EN ISO 10545-2
5.3 Skewness	± 1.5% ± 0.8%	± 1.5% ± 0.8%	± 0.5%	± 0.5%	DIN EN ISO 10545-2
6. Surface Quality	at least 95%	at least 95%	at least 95%	at least 95%	DIN EN ISO 10545-2
7. Color Deviations	•	•	•	•	DIN EN ISO 10545-16
7.1 Color Shade Grading	•	•	•	•	Deutsche Steinzeug
8. Size Grading ¹⁾	•	•	•	•	Deutsche Steinzeug
B) Physical Properties				glazed	
1. Water Absorption on average / max. individual value	AI _a E ≤ 0.5%/0.6% AI _b 0.5% < E ≤ 3%/3.3%	≤ 6/6.5%	BI _a ≤ 0.5% BI _b ≤ 3%	> 10%	DIN EN ISO 10545-3
2. Modulus of Rupture	AI _a min. 28 (21)N/mm ² AI _b min. 23 (18)N/mm ²	min. 20 (18)N/mm ²	BI _a min. 35 (32) N/mm ² BI _b min. 30 (27) N/mm ²	Thickness < 7.5mm: 15N/mm ² Thickness ≥ 7.5mm: 12N/mm ²	DIN EN ISO 10545-4
2.1 Breaking Strength ≥ 7,5 mm thickness	AI _a min. 1300 N AI _b min. 1100 N	at least 950 N	BI _a min. 1300 N BI _b min. 1100 N	at least 600 N	DIN EN ISO 10545-4
2.2 Break. Str. < 7,5 mm thickness	at least 600 N	at least 600 N	at least 700 N	at least 200 N	DIN EN ISO 10545-4
3. Resistance to Shock	•	•	•	•	DIN EN ISO 10545-5
4. Resistance to Deep Abrasion	≤ 275 mm ³	≤ 393 mm ³	≤ 175 mm ³	–	DIN EN ISO 10545-6
5. Resistance to Glaze Abrasion	0-5	0-5	0-5	0-5	DIN EN ISO 10545-7
6. Max. Coefficient of Expansion	•	•	•	•	DIN EN ISO 10545-8
7. Thermal Shock Resistance	•	•	•	•	DIN EN ISO 10545-9
8. Moisture Expansion	< 0.001mm/m	< 0.001mm/m	appr. 0.001mm/m	appr. 0.01mm/m	DIN EN ISO 10545-10
9. Resistance to Glaze Cracking	required	required	required	required	DIN EN ISO 10545-11
10. Thermal Conductivity	appr. 1 W/mK	appr. 1 W/mK	appr. 1 W/mK	appr. 0,8 W/mK	Deutsche Steinzeug
11. Electrical Leakage Resistance	> 10 ¹⁰ Ohm ³⁾	> 10 ¹⁰ Ohm ³⁾	10 ¹⁰ Ohm	10 ¹⁰ Ohm	DIN EN 1081
12. Steam Diffusion Resistance	appr. μ 120,000	appr. μ 120,000	appr. μ 120,000	appr. μ 100,000	DIN EN ISO 12572
13. Resistance to Frost	required	not required, but met by AGROB BUCHTAL	required	–	DIN EN ISO 10545-12
14. Light an Color Fastness	•	•	•	•	DIN 51094
15. Luminance	acc. to specifications	acc. to specifications	acc. to specifications	acc. to specifications	Deutsche Steinzeug
16. Behaviour in Fire	A1/A1 _{fl}	A1/A1 _{fl}	A1/A1 _{fl}	A1/A1 _{fl}	DIN 4102/DIN EN 13501-1
C) Chemical Properties²⁾					
1. Resistance to Chemicals	see test certificate	see test certificate	see test certificate	see test certificate	DIN EN ISO 10545-13
2. Resistance to Household Chemicals and Bath Water Additives	min. GB or UB	min. GB or UB	min. GB or UB	–	
3. Stain Resistance (glazed)	min. Kl. 3	min. Kl. 3	min. Kl. 3	min. Kl. 3	DIN EN ISO 10545-14
4. Lead and Cadmium Delivery	•	•	•	•	DIN EN ISO 10545-15
5. Hytect	see test certificate	see test certificate	see test certificate	see test certificate	Deutsche Steinzeug
D) Slip resistance					
1. Coefficient of Friction	•	•	•	–	E-DIN EN ISO 10545-17
1.1 Industrial Areas (BG) Trade Associations	Groups R9-13/V4-10	Groups R9-13/V4-10	Groups R9-13/V4-10	–	DIN EN 16165, Annex B DGUV-R 108-003 (BGR 181)
1.2 Barefoot Areas (BUK) German National Association of Accident Insurance Companies	Groups A/B/C	Groups A/B/C	Groups A/B/C	–	DIN EN 16165, Annex A DGUV-I 207-006 (GUV-I 8527)

1) Boxes marked according to size and color shade.

2) Hydrofluoric acid and its compounds excluded.

3) Exceptions:

KerAion ELA 10.6: Electrical Leakage Resistance 10⁹ Ohm (DIN EN 1081)

Eladuct 10⁸

All references to as well as quotations from product and test standards are to be considered as information which is not binding. The latest versions apply.

Deutsche Steinzeug tiles present better values than required by the standards.

In addition, they are construction biologically, ecologically, hygienically and bacteriologically safe; this is guaranteed through the choice of raw materials, method of processing and firing technique.

Terms and Classification according to DIN EN 14411

All our tiles consist of natural raw materials such as clay, quartz sand and feldspars, which are processed, refined and fired. Depending on the application they are manufactured with a glazed (GL) or unglazed (UGL) surface. They can be classified in accordance with DIN EN 14411 as follows:

Classification of the ceramic tiles according to their groups of water absorption (E) and their shaping

Shaping	Group I E ≤ 3%	Group II _a 3% < E ≤ 6%	Group II _b 6% < E ≤ 10%	Group III E > 10%
A extruded tiles	Group AI _a E ≤ 0.5% (Annex M)	Group All _{a-1} ^{a)} (Annex B)	Group All _{b-1} ^{a)} (Annex D)	Group All (Annex F)
	Group AI _b 0.5% < E ≤ 3% (Annex A)	Group All _{a-2} ^{a)} (Annex C)	Group All _{b-2} ^{a)} (Annex E)	
B dry-pressed tiles	Group BI _a E ≤ 0.5% (Annex G)	Group BII _a (Annex J)	Group BII _b (Annex K)	Group BIII _b (Annex L)
	Group BI _b 0.5% < E ≤ 3% (Annex H)			
a) The groups All _a and All _b are subdivided into two parts (parts 1 and 2) with different product requirements. b) Group BIII essentially applies to glazed tiles. There is a small number of dry-pressed unglazed tiles manufactured with a water absorption of more than 10% to which this product group does not apply.				

Traditionally the following terms are used:

Extruded tiles

(marked with A)

Tiles that are cut off with a certain length from a bar formed from the plastic mass by means of an extruder.

Dry-pressed tiles

(marked with B)

Tiles that are formed from a finely ground and subsequently granulated mass by pressing under high pressure.

Split tiles are frost-resistant, extruded double-tiles which are fired at a temperature of up to max. 1280 °C in upright position.

Stoneware tiles are frost-resistant, single extruded vitrified tiles with a firing temperature of appr. 1260 °C.

KerAion is the unique extruded ceramic large-size panel from Agrob Buchtal.

Vitrified dry-pressed tiles are frost-resistant, single dry-pressed tiles with a firing temperature of up to 1200 °C.

Porcelain stoneware stands for especially densely sintered tiles with a water absorption of < 0.5 %.

Mosaics are small (porcelain) stoneware tiles stuck onto sheets.

Earthenware tiles are non-frost-resistant, single dry-pressed tiles with a firing temperature of up to appr. 1100 °C.

The water absorption E in weight-% is determined in accordance with DIN EN ISO 10545-3.

Description of dimensions

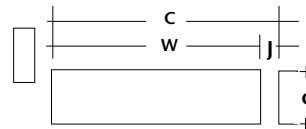

Coordinating dimension (C) in cm = Work size (W) + joint (J)

Work size (W) in mm = Dimensions of the visible surfaces and thickness (d)

Dimensions and Surfaces

1-5. Dimensions, DIN EN ISO 10545-2

All dimensions are determined in accordance with the standard.

Permissible length and width tolerances corresponding to the product standards						
DIN EN 14411	Group AI _a / AI _b (25x12.5 cm)		Group All _a (25x12.5 cm)		Group BI _a / BI _b (30x30 cm)	Group BIII (10x10 cm)
	„Nature“	„Precision“	„Nature“	„Precision“		
Deviation from the work size	± 2%, max. 4 mm	± 1%, max. 2 mm	± 2%, max. 4 mm	± 1.25%, max. 2 mm	± 0.6%, max. 2 mm	± 0.2%, max. 2 mm
Deviation from the average side length	± 1.5%	± 1.0%	± 1.5%	± 1.0%	± 0.5%	± 0.5%

The work sizes of our **special pieces** are given according to visual sides.

6. Surface Quality, DIN EN ISO 10545-2

The surfaces of 1 m² or 30 pieces are tested at 300 lux for visible defects at a distance of 1 m.

7. Color Deviations, DIN EN ISO 10545-16

Glazed mono-colored products with values of ΔE_{cm} < 0.75 are considered as identical in color; the value of 1.0 applies to unglazed mono-colored products.

7.1. Color Shade Grading

The color shade code is stamped on the box. Only identical color shades will result in a uniform surface look. In the case of rustic split tiles greater color deviations are normal. During laying, tiles from different boxes should be mixed.

8. Size Grading

The production sizes vary for technical reasons. The production size is coded and stamped on the box. Only boxes with the same coding should be laid together. According to VOB, the differences are evened out in the joints.

Physical Properties

1. Water Absorption, DIN EN ISO 10545-3

The **water absorption (E)** gives the weight increase as compared to the dry weight of samples saturated with water under vacuum.

1.1 Apparent Density, DIN EN ISO 10545-3

It gives the ratio between mass and external volume.

2. Modulus of Rupture, DIN EN ISO 10545-4

The breaking strength **F** is determined on samples by means of the tree-point load in **N**. From this, the modulus of rupture and the breaking load are calculated according to the following formula.

Modulus of Rupture

$$R = \frac{3 \cdot F \cdot L}{2 \cdot b \cdot h^2}$$

F = breaking strength in N
L = bearing span in mm
b = width in mm
h = thickness in mm
R = modulus of rupture

Breaking Load

$$S = \frac{F \cdot L}{b}$$

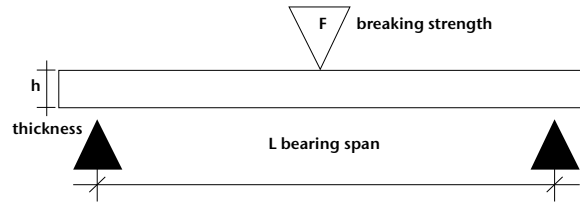

Possible Applications	Stress Group
Breaking strength under 1,500 N Housing construction and floor coverings subject to comparable mechanical stress, e.g. hotel bathrooms, rooms in the health service sector	1
Breaking strength 1,500 – 3,000 N Administration, trade and industry (practicable with vehicles with pneumatic tyres), e.g. canteen kitchens, canteens, traffic zones, car exhibition and maintenance areas, sales rooms, always without industrial truck traffic Floor pressures up to 2 N/mm ²	2
Breaking strength 3,000 – 5,000 N Trade and industry (industrial truck traffic with superelastic, solid rubber and vulkollan tyres), e.g. in food retailing and wholesaling, non-food retailing and wholesaling, shopping malls Floor pressures 2 to 6 N/mm ²	3
Breaking strength 5,000 – 8,000 N Trade and industry; areas of application as in group 3, but practicable with polyamide rollers Floor pressures 6 to 20 N/mm ²	4
Breaking strength above 8,000 N Trade and industry; heavy-duty areas with industrial truck traffic with polyamide rollers; runners of metal parts, such as e.g. in factory buildings, assembly halls and storerooms, repair workshops for machines and heavy equipment Floor pressures > 20 N/mm ²	5

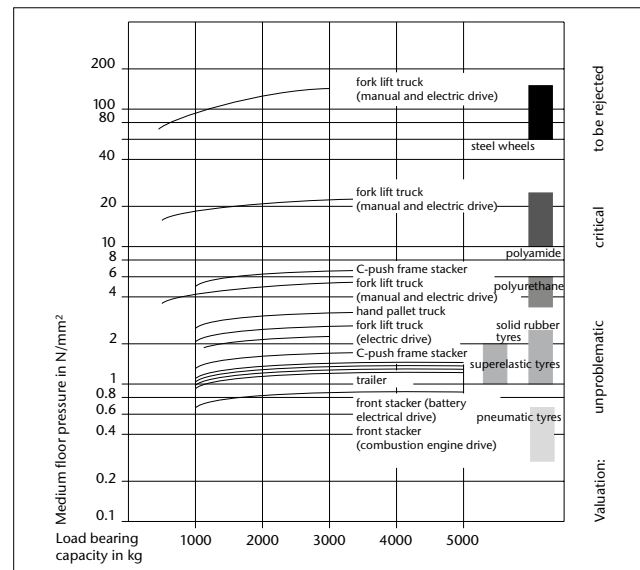

Floor pressures in N/mm² of industrial truck wheels according to a FMPA test in Stuttgart

The table illustrates the floor loads and indicates the effect of the different wheel types: steel wheels should be rejected and polyamide (Nylon and Perlon) is not advisable. Softer tyres (≤ 75 Shore-A-Hardness) as well as larger wheel diameters and wider supporting surfaces are especially advantageous.

Important note:

The "application possibilities" are of course only recommendations, as the method and quality of laying are decisive factors. Our recommendations are based on conventional, professional laying. With increasing mechanical load as well as harder tyres a thicker tile is required.

All references to as well as quotations from product and test standards are to be considered as information which is not binding. The latest versions apply.

Mechanical Strength

Deutsche Steinzeug offers tiles in thicknesses from 5 up to 20 mm for extreme loads in industrial and commercial areas.

The breaking load values of our products partly are by far better than the values required by DIN EN 14411 (the relevant test certificates will be made available on request).

The calculated breaking load indicates the suitability for floors subject to mechanical loads. The stress itself is caused by bending rather than by pressure. The “extra strong” tiles from our programme with their high pressure, breaking and bending strength values are the ideal covering for floors subject to heavy loads. They withstand the wheels of industrial trucks, fork lift trucks and platform lift-trucks with their high floor pressure. They are especially suitable as floor coverings for industrial logistics, hyper- and supermarkets.

3. Compressive Strength

The compressive strength of tiles is not standardized. In the case of vitrified dry-pressed tiles it reaches values of up to 150 N/mm². The following conversion table shows the importance of a perfect and professional embedding of the tiles on site. The relatively low values for cement and thin-bed mortar can only be compensated by special and professional laying (mortar composition, water/cement value and manual or mechanical compression).

4. Resistance to Shock, DIN EN ISO 10545-5

Rebound measurement with 5 samples.

5. Resistance to Deep Abrasion, DIN EN ISO 10545-6

With regard to the deep abrasion on unglazed tiles, the abrasion is determined by means of fusion corundum and a rubbing plate. The lower the value, the higher the wear resistance of the material.

6. Glaze Abrasion, DIN EN ISO 10545-7

The abrasion class of glazed tiles is established in the wet test. Artificial abrasion is produced with the help of aluminium oxide grains, steel balls and the addition of water in an eccentrically revolving system. The number of revolutions at which a visible change of the test surface occurs results in the following classification:

Resistance to Surface Abrasion	
Class	Revolutions
0	100
1	150
2	600
3	750/1500
4	2100/6000/12000
5	>12000*

* Must pass the stain test according to DIN EN ISO 10545-14.

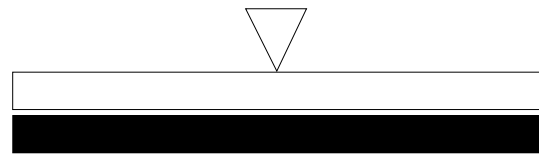

Vitrified material has a compressive strength approx. 10 - 20 times higher than cement mortar, cast plaster floors and reinforced concrete.

Conversion table for different materials

Types of material	N/mm ²	N/cm ²	kN/cm ²
Vitrified dry-pressed tiles	100 – 150	10,000 – 15,000	10 – 15
Extruded split tiles	180 – 250	18,000 – 25,000	18 – 25
Cement mortar Gr. III	10	1,000	1
High-grade cement mortar	20	2,000	2
Thin-bed mortar	15 – 30	1,500 – 3,000	1.5 – 3
Epoxy resins	60 – 75	6,000 – 7,500	6 – 7.5
Cement screed CT, C12 (ZE 12)	12	1,200	1.2
CT, C20 (ZE 20)	20	2,000	2
CT, C30 (ZE 30)	30	3,000	3
Mechanically resistant floor 65	65	6,500	6.5
Reinforced concrete C 20/25 (B 25)	25	2,500	2.5
C 30/37 (B 35)	35	3,500	3.5

Class 0

The use of glazed tiles of this class for floor coverings is not recommended.

Class 1

Floor coverings in areas mainly walked on in soft footwear or barefoot and not exposed to abrasive dirt (e.g. bathrooms and bedrooms without direct access from outside).

Class 2

Floor coverings in areas occasionally walked on with soft or normal footwear and exposed to little abrasive dirt (e.g. rooms in living areas of houses, except kitchens, entrances and similar heavily frequented rooms). This does not apply to special footwear such as e.g. hobnailed boots.

Klasse 3

Floor coverings in areas frequently walked on with normal shoes and exposed to little abrasive dirt (e.g. kitchen-cum-living-rooms, halls, corridors, balconies, loggias and terraces). This does not apply to special footwear such as e.g. hobnailed boots.

Class 4

Floor coverings walked on regularly and exposed to little abrasive dirt, so that they are subject to greater stress as in the case of class 3 (e.g. commercial kitchens, hotels, exhibition and sales rooms).

Class 5

Floor coverings subject to heavy pedestrian traffic over long periods of time and exposed to little abrasive dirt, so that they are subject to the most extreme stress under which glazed tiles can be applicable (e.g. public areas such as shopping centres, entrance halls of airports, hotel foyers, public footpaths and industrial applications).

Every floor covering is subject to wear. This depends on the area of application and the frequency of use, the kind and degree of dirt as well as the hardness and resistance to wear of the covering material. While unglazed vitrified floor tiles can be used practically anywhere, glazed floor tiles have to be categorized according to stress groups. Scrapers, mats and the like help to remove dirt and abrasives and to protect glazed floor coverings. Something of this kind has to be provided especially in rooms with direct access from outside or from the garden.

Extreme Stress

For such areas we recommend the use of integrally colored, unglazed tiles, which are available in a wide range of colors and sizes. Examples: floors subject to high traffic loads, e.g. in supermarkets, hotels, schools, administrative buildings, railway stations, hospitals, passageways, etc., taking into account the mechanical load.

7. Coefficient of Expansion, DIN EN ISO 10545-8

The coefficient of expansion is ascertained between room temperature and 100°C ermittelt. The measured values are at around 6.0×10^{-6} m/(mK) in the case of vitrified materials and at around 8.0×10^{-6} m/(mK) in the case of porcelain stoneware. At 8 m length and 50° temperature difference the result is a change in length of approx. 2.4 mm in the case of vitrified materials (in the case of screed/concrete 4.6 mm and steel 5.6 mm).

8. Thermal Shock Resistance, DIN EN ISO 10545-9

The thermal shock resistance is tested between 15° and 145°C.

9. Moisture Expansion, DIN EN ISO 10545-10

The moisture expansion is determined between tempered and water-saturated samples.

10. Resistance to Glaze Cracking, DIN EN ISO 10545-11

This test takes place in the autoclave at 500 KPa with subsequent color control.

Glazes with hair cracks/crazes are marked as such and require the wetting of the covering prior to pointing to avoid deposits of fine particles of the pointing mortar in the hair cracks. Colored pointing compounds are not suitable in the case of these glazes. The glaze surfaces must not be marked with felt-tip pen and the like.

11. Thermal Conductivity etc.

Thermal conductivity, heat radiation and storage capacity as well as the thermal resistance are not standardized. Vitrified material produces the following approximate values:

Thermal conductivity:	1 W/mK	Heat storage capacity:	0.8 kJ/kgK
Heat radiation:	5.3 W/m ² K ⁴	Thermal resistance:	0.01 m ² K/W

12. Electrical Leakage Resistance

With a volume resistance of $>10^{10}$ Ohm (DIN EN 1081), our ceramics is insulating in dry condition. With the series Eladuct and KerAion ELA 10.6, however, we offer ceramics for floors capable of discharging static electricity. The glaze of ELA 10.6 has a surface resistance of approx. 106 Ohm according to DIN EN 1081. The discharge of static electricity is effected from the glaze via conductive joints and tile adhesive into copper strips to be connected to earth, which are laid on the base to be tiled. In the case of Eladuct, the complete tile body is capable of discharging static electricity. The volume resistance according to DIN EN 1081 is approx. 108 Ohm. Here, conductive joints are not required; apart from that, the base has to be carried out as described for ELA 10.6.

13. Steam Diffusion Resistance

According to DIN EN ISO 12572 the steam diffusion resistance is approx. μ 120,000 in the case of vitrified material/split tiles and μ 100,000 in the case of earthenware (excluding joints).

14. Resistance to Frost, DIN EN ISO 10545-12

The test for frost resistance is carried out on 10 samples or >0.25 m² samples. After water saturation under vacuum the samples are checked for defects after 100 frost-thaw alternations.

The resistance to frost of an outdoor flooring, however, does not only depend on the quality of the ceramic tiles used. **Professional construction and laying are essential.** For this, please refer to our specifications and the notice of the umbrella organization of the German building and construction industry "Outdoor Tiled and Paved Coverings".

15. Light and Color Fastness

Both glazed and unglazed ceramics are light- and color-fast according to DIN 51094.

16. Luminance

The lightness value of a tile describes the brightness of the surface as perceived by the human eye. The measuring value $Y = 100$ corresponds to the brightness of an absolutely white surface, and $Y = 0$ to that of an absolutely black surface.

The lightness value is determined for mono-colored tiles.

17. Behaviour in Fire

Ceramic tiles are classified A 1 according to EN ISO 13501-1 and DIN EN 14411. Therefore, they are generally non-combustible and thus fire-resistant. Also in the case of fire they do not release any toxic emissions.

Chemical Properties

1. Resistance to Chemicals, DIN EN ISO 10545-13

Resistance to Household Chemicals and Bath Water Additives

- Household chemicals
 - Ammonium chloride solution 100g/l
- Bath salts
 - Sodium hypochlorite solution 20mg/l

Classes

A/B/C*

Resistance to Acids and Alkalies

- Low concentration (L)
 - a) Hydrochloric acid solution 3% (V/V)
 - b) Citric acid solution 100g/l
 - c) Potassium hydroxide solution 30g/l
- High concentration (H)
 - a) Hydrochloric acid solution 18% (V/V)
 - b) Lactic acid solution 5% (V/V)
 - c) Potassium hydroxide solution 100g/l

Classes

LA/LB/LC or HA/HB/HC*

Acid Protection and Apparatus Engineering

The resistance for acid protection engineering DIN EN 993-16 or chemical apparatus engineering DIN 28062 is subject to individual tests.

* Class A shows the highest resistance to chemicals, which decreases more and more towards C.

2. Stain Resistance, DIN EN ISO 10545-14

Stain Forming Substances

- Stain forming substances, leaving traces
 - Green stain forming substances in oil
 - Red stain forming substances in oil
- Chemical stain forming substances
 - Iodine, 13g/l in alcohol
- Stain forming substances, forming a film Olive oil

Cleaning (within the framework of the test)

- Cleaning agent
 - Hot water (+55 °C)
 - Weak cleaning agent
 - Strong cleaning agent
- Solvent
 - Hydrochloric acid solution 3% (V/V)
 - Potassium hydroxide 200g/l
 - Acetone

Classes

Cl. 5 / Cl. 4 / Cl. 3 / Cl. 2 / Cl. 1*

3. Lead and Cadmium Delivery

The glazed surfaces are exposed to a 4 percent acetic acid solution. Then, the quantity of the delivered lead and cadmium is determined.

* Class 5 shows the highest stain resistance, which decreases more and more towards 1.

Surface Coatings and Upgradings

Hytect

Hytect is a highly effective and durable coating of tiles and panels of Deutsche Steinzeug.

The coating baked onto the surface on the base of titanium dioxide uses the principle of the photocatalysis.

It offers the user the following advantages:

A) Hytect decomposes bacteria and germs

The surface is activated by sunlight or artificial lighting. Activated oxygen forms, which decomposes microorganisms.

B) Hytect eliminates disagreeable odours

Disagreeable or even unhealthy odours in the air are also eliminated by Hytect.

C) Hytect reduces the cleaning efforts

The hydrophilic surface makes it possible for water to get under the dirt. In this way the quantity of cleaning agents is considerably reduced, which means a contribution to environmental protection and the saving of time for manual works at the same time.

Hytect surfaces are odourless, non-poisonous, meet the requirements for food and are completely harmless for persons suffering from allergies.

Laying and pointing are carried out by the usual techniques. The conventional agents (without hydrofluoric acid and its compounds) are applicable for cleaning. All additives forming a film, leaving fat on the surface or impregnating are excluded, which impair the surface activation by light.

Renowned institutes in Germany and abroad have confirmed us the corresponding effects of Hytect.

Protecta Surface Upgrading



Better Beats Good ...

Unglazed vitrified tiles are hard-wearing and resistant by nature. Thanks to the Protecta surface upgrading, the stain and dirt resistance could be improved considerably: during the firing process, the coating applied in-plant is ceramically bonded to the biscuit and closes the existing "micropores" quite natural for unglazed ceramics. In this way, the penetration of substances forming stains is prevented. Thus, an impregnation is no longer required and may possibly even have a negative effect in the case of slip-resistant tiles with Protecta surface upgrading, as the impregnating agent can not penetrate the tile but remains on the surface as lubricating film.

Products with Protecta surface upgrading are marked with this symbol in the corresponding series:



Hygiene

Glazed tiles and tiles with Protecta surface upgrading of Deutsche Steinzeug ensure the best possible hygiene conditions. Thanks to the closed surface, they offer no possibility for germs to proliferate. Tests of institutes for hygiene confirm the suitability for the covering of drinking water reservoirs. Hyper-sensitive people such as those suffering from allergies make the best experiences with tiles.

Cleaning

On principle, claddings and coverings must be protected by appropriate measures against heavy soiling which may be caused in particular by subsequent construction works (painting etc.).

Our tiles can generally be cleaned with water and a neutral or alkaline cleaning agent.

In the case of hard water, the sporadic use of acid cleaning agents is required. In the case of stains, cleaning depends on the type of stains and has to be carried out with suitable chemicals.

In the case of a higher concentration of the cleaning agent used, subsequent wiping with clear water is required. Rinsing with clear water is absolutely necessary when carrying out a basic cleaning. Cleaning agents containing maintenance additives are not recommended by us. They usually reduce the slip resistance and cause a negative visual appearance of the floor covering by forming layers! Important: the use of cleaning machines with pads containing abrasive grain has a polishing effect by which the slip resistance of the tiles is considerably reduced. We therefore expressly disapprove of such methods. Hydrofluoric acid or its compounds attack the ceramics and cause irreversible damage!

You will find detailed cleaning instructions for ceramic tiles on the Internet at www.agrob-buchtal.de

- Service
- Architects & Planners / Dealers / Tilers
- Cleaning instruction.

Impregnation

Unglazed stoneware without Protecta surface upgrading or Hytect coating should be impregnated in order to prevent the penetration of colored liquids, fats and oils and to facilitate cleaning.

The impregnating agent must be applied on the clean and dry floor; excess material must be removed immediately.

Slip Resistance

1. Coefficient of Friction/Slip Resistance

Workshop rules as well as accident prevention regulations require floors to be smooth, slip-resistant and easy to clean. Special protective measures against slipping are necessary where there is a risk as a result of the use of water, oil, slush, grease or waste. This should be taken into consideration when choosing the surface material. This clear requirement is based on investigations carried out by the insurance companies, which proved that slipping is the primary cause of accidents.

1.1. Industrial Areas

Competent authority:

Deutsche Gesetzliche Unfallversicherung,
Mittelstraße 51, 10117 Berlin-Mitte, phone: +49 (0)30 28876-3800,
fax: - 3808, www.dguv.de, info@dguv.de

Test standards: DIN EN 16165 and DIN 51133

Guideline: ASR A 1.5 - Floors

Code of practice: DGUV regulation 108-003 "Floors in work rooms and work areas with high risk of slipping" (previous BGR 181)

Test procedure: Inclined plane, safety footwear worn, test medium oil. The surface finish can be smooth, fine-rough, rough or profiled.

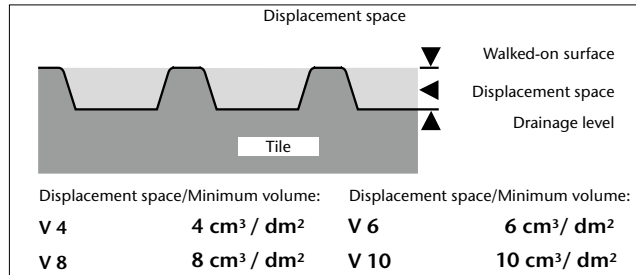

The displacement space (V4-V10) is the open space between the upper walked-on surface and the drainage level of profiled surfaces.

Valuation Groups

In a detailed table (see next page) the required valuation groups are assigned to work areas where there is a high risk of slipping. Information is available from Deutsche Gesetzliche Unfallversicherung and Agrob Buchtal.

Test on "inclined plane"

Valuation groups	Angle of inclination	Industrial + commercial areas
R9	> 6°- 10° low static friction	
R10	> 10°- 19° normal static friction	
R11	> 19°- 27° increased static friction	
R12	> 27°- 35° high static friction	
R13	> 35° very high static friction	

The indicated angles of inclination exclusively serve for the assignment of the valuation groups and can not be equated with the angles of inclination of slopes/ramps.

Slip-resistant tiles are marked with the logo "GRIP" in the corresponding series:



Legal Basis

Workshop rules as well as accident prevention regulations require floors to be smooth, slip-resistant and easy to clean.
The brochure "Technische Regel für Arbeitsstätten" ASR. A 1.5 – Floors (Code of practice for work areas) contains detailed requirements.

Publisher:

Bundesanstalt für Arbeitsschutz und Arbeitsmedizin (Ausschuss für Arbeitsstätten)
[Federal institute for safety at work and occupational medicine (Committee for work areas)]

Available at:

Download at www.baua.de

0 General work rooms and areas*

0.1	Entrance areas, indoors**)		R9
0.2	Entrance areas, outdoors		R11 (or R10 V4)
0.3	Stairs, indoors***)		R9
0.4	Outdoor stairs		R11 (or R10 V4)
0.5	Inclined ramps, indoor****) (from a slope of 3 %; e.g. for wheel chairs, compensation slopes, routes of transport)	One R-group higher than that required for the covering of the access area	V-Value of the covering of the access area, where applicable
0.6	Sanitary rooms		
0.6.1	Toilets		R9
0.6.2	Changing rooms and washrooms		R10
0.7	Break rooms (e.g. recreation room, company canteens)		R9
0.8	First aid rooms and comparable facilities (see ASR A4.3)		R9

1 Manufacture of margarine, edible fats and oils

1.1	Melting of fat		R13 V6
1.2	Cooking oil refinery		R13 V4
1.3	Margarine production and packaging		R12
1.4	Cooking fat production and packing, oil bottling		R12

2 Milk processing, cheese production

2.1	Fresh milk processing and butter production		R12
2.2	Cheese production, storage and packaging		R11
2.3	Icecream manufacturing		R12

3 Chocolate and confectionery production

3.1	Sugar processing		R12
3.2	Cocoa production		R12
3.3	Production of raw mixtures		R11
3.4	Fabrication of chocolate bars and shells and filled chocolates		R11

4 Production of bread, cakes and pastries

	(bakeries, cake shops, production of long-life bakery products)		
4.1	Dough preparation		R11
4.2	Rooms in which predominantly fats or liquid mixtures are processed		R12
4.3	Washing-up rooms		R12 V4

5 Slaughtering, meat processing

5.1	Slaughter-house		R13 V10
5.2	Tripe processing room		R13 V10
5.3	Meat sectioning		R13 V8
5.4	Sausage kitchen		R13 V8
5.5	Boiled sausage unit		R13 V8
5.6	Raw sausage unit		R13 V6
5.7	Sausage drying room		R12
5.8	Gut store		R12
5.9	Salting and curing rooms, smoking establishments		R12
5.10	Poultry processing		R12 V6
5.11	Cold cuts and packaging unit		R12
5.12	Workshop with sales area		R12 V8 ****)

6 Fish processing, production of delicatessen

6.1	Fish processing		R13 V10
6.2	Production of delicatessen		R13 V6
6.3	Manufacture of mayonnaise		R13 V4

7 Processing of vegetables

7.1	Production of sauerkraut		R13 V6
7.2	Vegetable tinning		R13 V6
7.3	Sterilizing rooms		R11
7.4	Rooms in which vegetables are prepared for processing		R12 V4

8 Wet areas in food and beverage production

	(if not specifically mentioned)		
8.1	Storage cellars		R10
8.2	Beverage bottling, fruit juice production		R11

9 Catering establishments

9.1	Kitchens in the catering trade (restaurant kitchens, hotel kitchens)		R12
9.2	Kitchens catering for homes, schools, day-care facilities for children, sanatoria		R11
9.3	Kitchens catering for hospitals, clinics		R12
9.4	Large kitchens catering for industrial and university canteens, and contract catering		R12
9.5	Food preparation kitchens (fast food kitchens, convenience restaurants and snack bars)		R12

9.6 Kitchens for heating up frozen meals R10

9.7 Coffee and tea kitchens, hotel garni kitchens and ward kitchens R10

9.8 Washing-up rooms R10

9.8.1 Washing-up rooms for 9.1, 9.4, 9.5 R12 V4

9.8.2 Washing-up rooms for 9.2 R11

9.8.3 Washing-up rooms for 9.3 R12

9.9 Dining rooms, guest rooms, canteens including serving counters R9

9.10 Counter area, bar area R10

10 Cold stores, deep freeze stores

10.1 for unpacked goods R12

10.2 for packed goods R11

11 Sales outlets, shops

11.1 Reception of goods, meat R11

11.1.1 for unpacked goods R11

11.1.2 for packed goods R10

11.2 Reception of goods, fish R11

11.3 Serving counters for meat and sausage R11

11.3.1 for unpacked goods (e.g. loose in transport boxes) R11

11.3.2 for packed goods R10

11.4 Serving counters for bread, cakes and pastries, unpacked goods R10

11.5 Serving counters for dairy products and delicatessen, unpacked goods R10

11.6 Serving counters for fish R12

11.6.1 for unpacked goods R11

11.6.2 for packed goods R9

11.7 Serving counters, except for nos. 11.3 to 11.6 R9

11.8 Meat preparation rooms R12 V8

11.8.1 for meat preparation, except for no. 5 R11

11.8.2 for meat processing, except for no. 5 R11

11.9 Florists shops R11

11.10 Sales areas with ovens R11

11.10.1 for the production of bread, cakes and pastries R10

11.10.2 for the warming up of prefabricated bread, cakes and pastries R12

11.11 Sales areas with chip pans or grills R9

11.12 Shops, customer rooms R10

11.13 Preparation areas for food for self-service shops (except for meat, fish and sausage) R10

11.14 Cash register areas, packing areas R9

11.15 Outdoor sales areas R11 (or R10 V4)

12 Health service rooms

12.1 Disinfection rooms (wet) R11

12.2 Pre-cleaning areas of sterilization R10

12.3 Faeces disposal rooms, discharge rooms, unclean nursing work rooms R10

12.4 Pathological facilities R10

12.5 Rooms for medical baths, hydrotherapy, fango preparation R11

12.6 Washrooms of operating theatres, plastering rooms R10

12.7 Sanitary rooms, ward bathrooms R10

12.8 Rooms for medical diagnosis and therapy, massage rooms R9

12.9 Operating theatres R9

12.10 Wards with hospital rooms and corridors R9

12.11 Medical practices, day clinics R9

12.12 Pharmacies R9

12.13 Laboratories R9

12.14 Hairdressing salons R9

13 Laundry

13.1 Rooms with continuous-flow washing machines or with spin-drier R9

13.2 Rooms with washing machines at which the clothes are taken out dripping wet R11

13.3 Ironing rooms R9

14 Fodder concentrate production

14.1 Dried fodder production R11

14.2 Fodder concentrate production using fat and water R11 V4

15 Leather production, textiles

15.1 Wet areas in tanneries R13

15.2 Rooms with fleshing machines R13 V10

15.3 Areas where leather scraps accumulate R13 V10

15.4 Rooms for making leather impermeable by means of grease R12

15.5 Dye mills for textiles R11

16 Paint shops

16.1 Wet grinding areas R12 V10

16.2 Powder coating R11

16.3 Painting R10

17 Ceramics industry

17.1 Wet grinding mills (processing of ceramic raw materials) R11

17.2 Mixers; handling of materials like tar, pitch, graphite and synthetic resins R11 V6

17.3 Presses (shaping); handling of materials like tar, pitch, graphite and synthetic resins R11 V6

17.4 Moulding, pressure die casting areas R12

17.5 Glazing areas R12

18 Glass and stone processing			
18.1 Stone cutting, stone grinding	R11	32.4 Pool surrounds	R10
18.2 Glass shaping of hollow glass ware, container ware	R11	<i>NOT recommended by Agrob Buchtal! Be sure to use R11 (in combination with valuation group B)!</i>	
18.3 Grinding areas for hollow glass ware, flat glass	R11		
18.4 Insulating glass manufacture; handling of drying agents	R11 V6		
18.5 Packaging, shipping of flat glass; handling of anti-adhesive agents	R11 V6		
18.6 Etching and acid polishing facilities for glass	R11		
19 Cast concrete factories			
19.1 Concrete washing areas	R11		
20 Storage areas			
20.1 Storage areas for oils and fats	R12 V6		
20.2 Storage areas for packed food	R10		
20.3 Outdoor storage areas	R11 (or R10 V4)		
21 Chemical and thermal treatment of iron and metal			
21.1 Pickling plants	R12		
21.2 Hardening shops	R12		
21.3 Laboratory rooms	R11		
22 Metal processing, metal workshops			
22.1 Galvanizing shops	R12		
22.2 Grey cast iron processing	R11 V4		
22.3 Mechanical processing areas (turnery, milling shop), punching room, pressroom, drawing shop (pipes, wires) and areas exposed to increased stress by oil and lubricants	R11 V4		
22.4 Parts cleaning areas, exhaust steam areas	R11 V4		
22.5 Partial cleaning areas, Damping areas	R12		
23 Vehicle repair workshops			
23.1 Repair and servicing bays	R11		
23.2 Working and inspection pits	R12 V4		
23.3 Car washing halls, washing areas	R11 V4		
24 Aircraft repair workshops			
24.1 Aircraft hangars	R11		
24.2 Repair hangars	R12		
24.3 Washing halls	R11 V4		
25 Sewage treatment plants			
25.1 Pump rooms	R12		
25.2 Rooms for sludge draining facilities	R12		
25.3 Rooms for screening equipment	R12		
25.4 Stands of workplaces, scaffolds and maintenance platforms	R12		
26 Fire brigade buildings			
26.1 Vehicle parking places	R12		
26.2 Rooms for hose maintenance equipment	R12		
27 Functional rooms in the respiratory protection training facility			
27.1 Preparation room	R10		
27.2 Fitness room	R10		
27.3 Training room	R11		
27.4 Sluice	R10		
27.5 Target room	R11		
27.6 Acclimatization room	R11		
27.7 Control room	R9		
28 Schools and day-care facilities for children			
28.1 Entrance areas, corridors, assembly halls	R9		
28.2 Class rooms, group rooms	R9		
28.3 Stairs	R9		
28.4 Toilets, washrooms	R10		
28.5 Instructional kitchens in schools (see no. 9.2, 9.6 or 9.7)	R10		
28.6 Kitchens in day-care facilities for children (also see no. 9)	R10		
28.7 Machine rooms for wood processing	R10		
28.8 Special rooms for handicrafts	R10		
28.9 Schoolyards	R11 (or R10 V4)		
29 Financial institutions			
29.1 Counter areas	R9		
30 Plant traffic routes in outdoor areas			
30.1 Footpaths	R11 (or R10 V4)		
30.2 Loading platforms			
30.2.1 covered	R11 (or R10 V4)		
30.2.2 uncovered	R12 (or R11 V4)		
30.3 Sloping ramps (from a slope of 3 %; e.g. for wheel-chairs, loading platforms)	R12 (or R11 V4)		
30.4 Tank-up areas			
30.4.1 covered	R11		
30.4.2 uncovered	R12		
31 Parking areas			
31.1 Garages, car-parks not exposed to weather influences*****)	R10		
31.2 Garages, car-parks exposed to weather influences	R11 (or R10 V4)		
31.3 Open-air parking areas	R11 (or R10 V4)		
32 Swimming pools			
32.1 Individual and common dressing rooms	R10		
32.2 Sauna and relaxation areas	R10		
32.3 Showers	R10		
<i>NOT recommended by Agrob Buchtal! Be sure to use R11 (in combination with valuation group B)!</i>			

1.2. Barefoot areas

Competent authority:

Deutsche Gesetzliche Unfallversicherung, Mittelstraße 51, 10117 Berlin-Mitte, tel.: +49 (0)30 28876-3800, fax: - 3808, www.dguv.de, info@dguv.de, www.unfallkassen.de.

Floors in wet barefoot areas, e. g. swimming pools, hospitals as well as dressing rooms, washrooms and showers in sports and work facilities.

Test standard: DIN EN 16165.

Code of practice: DGUV information 207-006 "Floor coverings in wet barefoot areas" (previous GUV-I 8527).

Testing method: Inclined plane, walked on barefoot, wetting agent solution as test medium.

The surfaces are smooth, micro-rough or slightly profiled. "Nonslip" glazes with their micro-rough surfaces have proved to be excellent in practice.

The various areas are assigned to the valuation groups. Information can be obtained from Deutsche Gesetzliche Unfallversicherung and Agrob Buchtal.

Valuation group A

- Barefoot passages and sanitary areas (nearly dry)
- Individual and common dressing rooms
- Pool floors in non-swimmer areas if the water depth is more than 80 cm in the entire area
- Sauna and relaxation areas (nearly dry)

Valuation group B



- Barefoot passages and sanitary areas, if not classified in group A
- Showers
- Steam baths
- Area of disinfecting spray facilities
- Pool surrounds
- Pool floors in non-swimmer areas if the water depth is less than 80 cm in certain areas
- Non-swimmer sections of wave-action pools
- Movable floors
- Paddling pools
- Ladders and stairs outside the pool area, if not classified in group C
- Accessible surfaces of diving platforms and diving boards, if not classified in group C
- Sauna and relaxation areas, if not classified in group A

Valuation group C

- Ladders and stairs leading into the water
- Stairs up to diving facilities and water slides
- Surfaces of diving platforms and diving boards over the length reserved for the diver (the slip-resistant surface of the diving platforms and diving boards must cover the front edge where the hands and the toes of the divers grip)
- Walk-through pools
- Inclined pool edge designs
- Kneipp basins, water-treading basins
- Ramps in the pool surround area with an inclination > 6 %
- Starting blocks

Walkable seating areas such as e.g. stands and pedestals near the pool into which moisture can be brought must be treated like floor coverings. If barefoot areas are regularly also walked on with footwear, the requirements according to ASR A1.5/1,2 must be observed in addition.

Test on "inclined plane"

Valuation groups	Angle of inclination	Barefoot area
A	$\geq 12^\circ$	
B	$\geq 18^\circ$	
C	$\geq 24^\circ$	

The indicated angles of inclination exclusively serve for the assignment of the valuation groups and can not be equated with the angles of inclination of slopes/ramps.

1.3. Measurement of sliding friction

Competent authority:

Deutsche Gesetzliche Unfallversicherung, Mittelstraße 51, 10117 Berlin-Mitte, tel.: +49 (0)30 28876-3800, fax: - 3808, www.dguv.de, info@dguv.de, www.unfallkassen.de.

Test standard: DIN 51131

Code of practice: DGUV information 208-041 "Assessment of the risk of slipping under operating conditions" (previous GUV-I 8687).

This test is not a type examination and thus is neither suitable for the choice of floor coverings at the planning stage nor for classification in a slip-resistance valuation group. The method can be applied, e.g. for assessing the success of cleaning measures or in the event of planned changes of utilisation.

For the choice of a floor covering, DGUV information 108-003 (previous BGR 181) and DGUV information 207-006 (previous GUV-I 8527) respectively must be applied exclusively!

1.4. Private areas

With regard to slip resistance, ceramic floor coverings in private areas are not subject to standard regulations. Independent of that, however, we recommend that you choose slip-resistant tiles according to your personal safety requirements.

Color Shade Variation

“Color shade variation” refers to the variations in color between the tiles of a certain color, i.e. the degree of shading. Our products are classified into 4 shading coefficients.

- V0 = No variation / no play of colors
- V1 = Low variation / low play of colors
- V2 = Medium variation / medium play of colors
- V3 = High variation / high play of colors
- V4 = Strong variation / strong play of colors

Mosaics glued thermoplastically on back: Permanently safe also in wet areas

The thermoplastic gluing of mosaics of the brands Agrob Buchtal and Jasba is also perfectly suitable for permanently wet and underwater areas. Analyses of independent institutes have proved that no microbiological infestation at the glass fibre net occurs under normal hygienic conditions. The bonding behaviour after dry and wet storage is better than the standard values. Thus, the thermoplastic gluing on back can be recommended not only for dry areas but also for underwater areas (swimming pools and whirlpools) as well as for permanently wet areas

such as showers and pool surrounds. In addition, the gluing on back facilitates laying and leads to considerable time saving compared to the film on the face side required so far.

The glass fibre net on the back largely prevents the penetration of tile adhesive in the joints. The time-consuming removal of the film and possible residues on the tile surface is no longer necessary, and the cladding of columns and curvatures is significantly simplified.



List of Addresses

Bundesanstalt für Arbeitsschutz und Arbeitsmedizin (BAuA)

(Federal institute for safety at work and occupational medicine)

Friedrich-Henkel-Weg 1-25, 44149 Dortmund

Telephone: +49-231-9071-0, Fax: -2454,

www.baua.de, poststelle@baua.bund.de

DGUV Rules and Regulations (BG/GUV)

Deutsche Gesetzliche Unfallversicherung

Mittelstraße 51, 10117 Berlin-Mitte,

Telephone: +49-30-28876-3800, Fax: -3808,

www.dguv.de, info@dguv.de

DIN/EN/ISO Standards Sheets

Deutsches Institut für Normung e. V., 10772 Berlin

Telephone: +49-30-2601-0, Fax: -60,

www.din.de, peter.anthony@din.de,

Available from:

Beuth Verlag GmbH, Burggrafenstraße 6,

10787 Berlin, Telefon: +49-30-2601-2201-0, Fax: -1260,

www.beuth.de, info@beuth.de

KOK-Directives for Swimming Pool Construction

RK-List of Tested Cleaning Agents

DGfB Rules and Regulations

Deutsche Gesellschaft für das Badewesen e. V.,

45130 Essen

Telephone: +49-201-87969-0, Fax: -20,

www.baederportal.com, info@baederportal.com

Directly available from the publisher

Bundesverband Keramische Fliesen e. V.

Luisenstraße 44, 10177 Berlin

Telephone: 030/27 59 59 74-0, Fax: -99

www.fliesenverband.de, info@fliesenverband.de

ZDB Notices

Professional Association for Tiles and Natural Stone in the

Central Association of the German Construction Industry

Kronenstr. 55-58, 10117 Berlin-Mitte,

Telephone: +49-30-20314-0, Fax: -419,

www.fachverbandfliesen.de, info@fachverband-fliesen.de

Available from:

Verlagsgesellschaft Rudolf Müller GmbH & CoKG,

Stolberger Straße 84, 50933 Köln

Postfach: 410949, 50869 Köln

Telephone: +49-221-5497-112, Fax: -6112

www.baufachmedien.de, service@rudolf-mueller.de

Quality Controls

Quality controls are carried out by:

- manufacturers themselves with strict sorting
- controls and special tests by the Deutsche Steinzeug laboratories
- individual and batch testing by external material testing institutions in Germany and abroad

Certificates

The characteristics and the quality of our products are constantly tested by acknowledged material testing institutions.

The corresponding test certificates are available.



* We will be pleased to make a survey of the certified individual products available to you on request.

Shower Tub System - Area Pro/Plural non-slip/Plural unglazed/Basis 3

The shower tub system consists of special tiles for realizing a shower tub integrated in the tile covering.

The shower tub system is a registered design. It meets the requirements of DIN 18040 "Barrier-free building" and DIN 18025 "Barrier-free living".

In Germany, the 10 mm lip means that it is possible to take full advantage of various housing grants.

The 100 mm modular dimension inclusive of a 3 mm wide joint guarantees perfectly hygienic tile coverings with a narrow joint width and accurately sized tiles.

As with all slip-resistant surfaces of Plural non-slip/Plural unglazed, the series Basis 3, the surfaces of both the glazed and the ceramically upgraded unglazed tiles are very easy to clean.

The shower tub system is predestined for wet areas in hospitals, sanatoriums, rehabilitation centres, old people's and nursing homes, but also for showers in commercial areas, swimming pool, sauna and sports facilities, hotel and private bathrooms.

1. The shower tub is a module with the necessary slope that can be integrated in the joint grid of the tile covering as required.

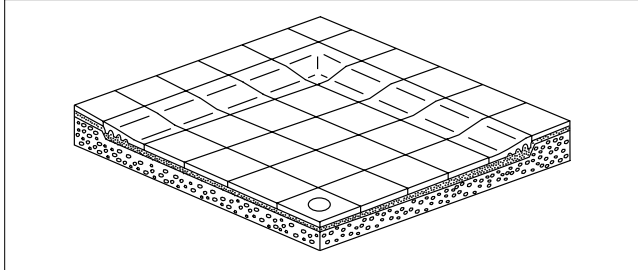

2. In combination with the cove skirting laid horizontally, a rounded transition between floor and wall covering is possible.

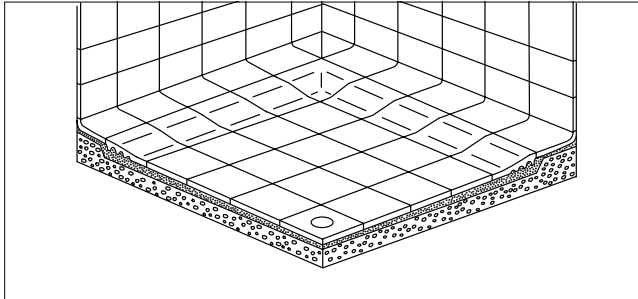

**Area Pro, Plural non-slip,
Plural unglazed**

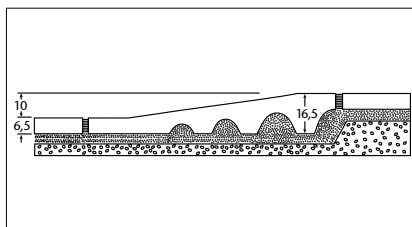
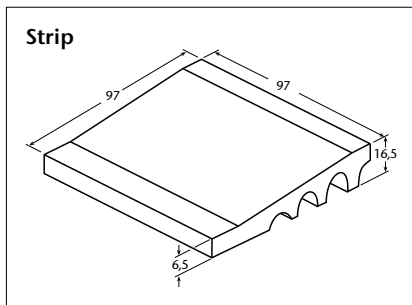
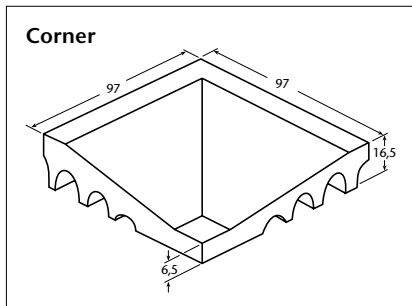

Basis 3 Softcorn

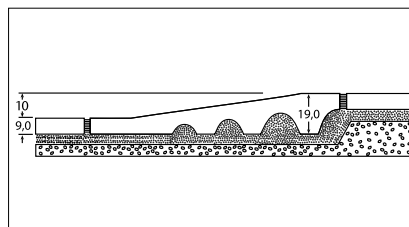
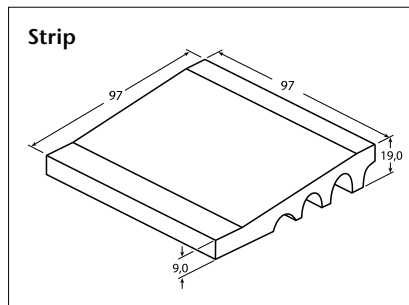
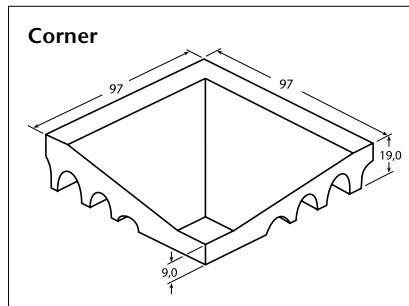

All references to as well as quotations from product and test standards are to be considered as information which is not binding. The latest versions apply.

The Shower Tub System of the Series Chroma / Chroma unglazed – Quantum

This shower tub system consists of only two components: the strip and the one-piece corner belonging to it.

A peculiarity of the system is the special form of the slope which provides a difference in height of 10 mm. The edge of the shower tub designed in this manner is easy to pass on foot and with a wheel-chair. The relevant requirements (DIN 18040 or 18025) with regard to barrier-free construction taking into account the needs of senior and handicapped persons are effectively supported in this way.

Thanks to the “integrated slope” the time-consuming execution of the edge of the shower tub on site is no longer required, and together with the even lower side facilitating laying the processing of these tiles is absolutely simple:

The shower tub system is perfectly completed by the series Chroma / Chroma unglazed – Quantum.

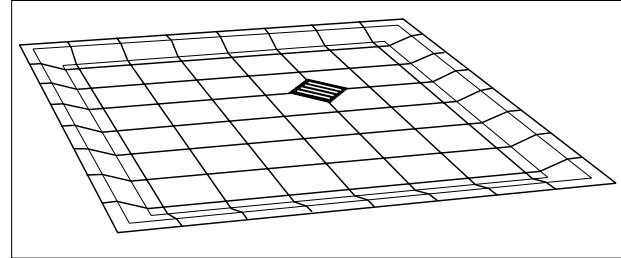

The shower tub system is based on a grid size of 12.5 x 12.5 cm. This permits a very variable dimensioning of the shower tub independent of standard dimensions and a harmonious integration in the shower installation or sanitary block.

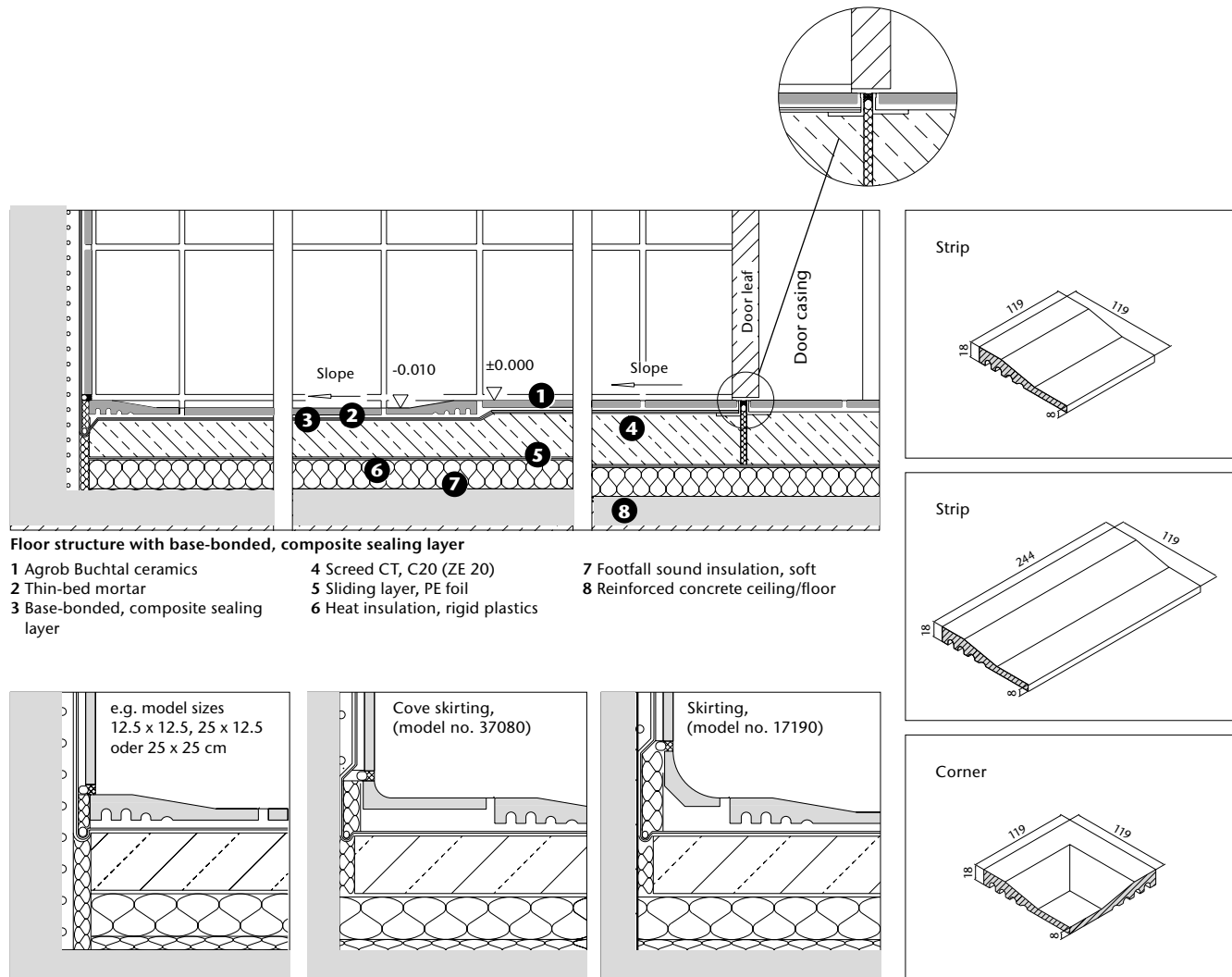

Wall connection variants

The shower tub systems of Agrob Buchtal are laid on a continuous screed and therefore do not require a high-maintenance movement joint between shower tub and adjoining areas.

All references to as well as quotations from product and test standards are to be considered as information which is not binding. The latest versions apply.

Cove Skirting

Cove Skirting 10 x 10 cm

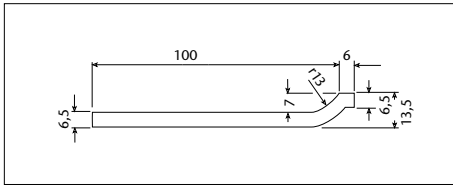

Fitting to:

Area Pro, smooth, 10 x 10 cm, unglazed
Plural/Plural non-slip, smooth and slip-resistant, 10 x 10 cm
Basis 2, smooth, 10 x 10 cm, glazed
Basis 3, smooth, 10 x 10 cm, unglazed
Plural unglazed, smooth, 10 x 10 cm

Cove Skirting 10 x 15, 10 x 20, 10 x 30 and 10 x 60 cm

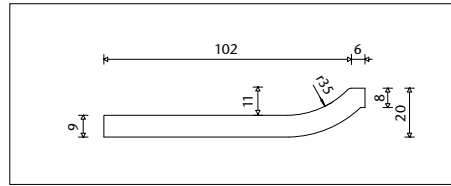

Fitting to:

Emotion GRIP, smooth or Softcorn, 10 x 20, 10 x 30 cm, unglazed
Basis 3, smooth, 10 x 15, 10 x 20 cm, unglazed
Basis Pro, smooth, 10 x 30 cm, unglazed
Area Pro, smooth, 10 x 20, 10 x 30 und 10 x 60 cm, unglazed

Cove Skirting 10 x 25, 10 x 50 and 10 x 60 cm

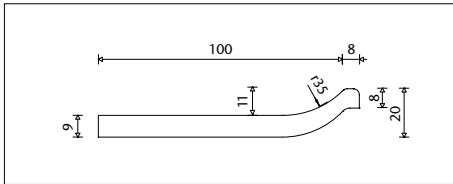

Fitting to:

Ascona, structured 10 x 25, 10 x 50, 10 x 60 cm glazed
Nova, smooth 10 x 60 cm glazed
Quarzit, structured 10 x 60 cm glazed

Cove Skirting 25 x 12.5 cm

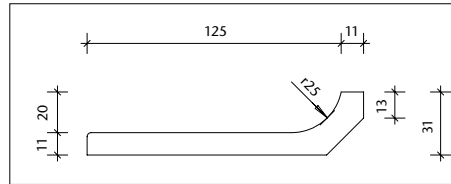

Fitting to:

Ferrum, smooth, 25 x 12.5 cm, unglazed

Internal corner

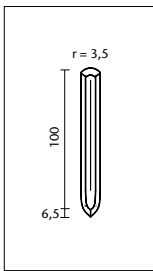

Fitting to cove skirting:

Plural non-slip, 10 x 10 cm, glazed

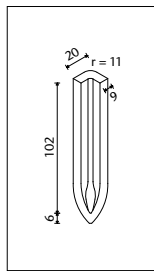

Fitting to cove skirting:

Area Pro, 10 x 10, 10 x 20, 10 x 30, 10 x 60 cm, unglazed
Emotion GRIP, 10 x 10, 10 x 20 und 10 x 30 cm, unglazed
Basis 3, 10 x 20 cm, unglazed

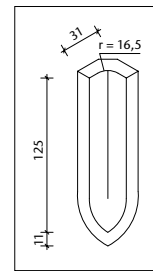

Fitting to cove skirting:

Ferrum, 25 x 12.5 cm, smooth, unglazed

External corner

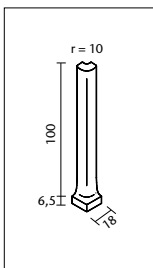

Fitting to cove skirting:

Plural non-slip, 10 x 10 cm, glazed

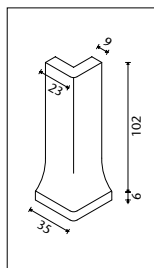

Fitting to cove skirting:

Area Pro, 10 x 10, 10 x 20, 10 x 30, 10 x 60 cm, unglazed
Emotion GRIP, 10 x 20 und 10 x 30 cm, unglazed
Basis 3, 10 x 20 cm, unglazed

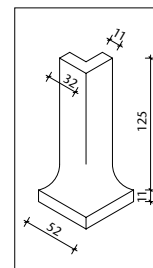

Fitting to cove skirting:

Ferrum, 25 x 12.5 cm, smooth, unglazed

Cove skirtings, cut/glued 15 x 60 cm and internal corners 15 x 15 cm

Details: Can be manufactured from any tiles/panels. The look and the haptics correspond to those of the adjoining surface, i.e. both the same structure and the same color are guaranteed. Minimum order quantity for the skirtings: 50 pieces; corner: 50 pieces.

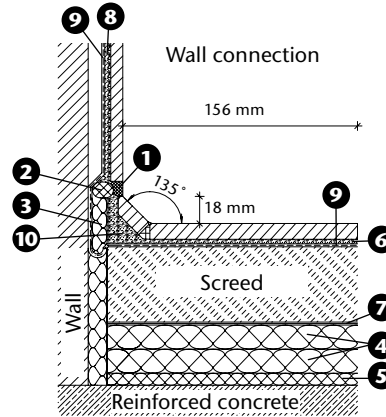
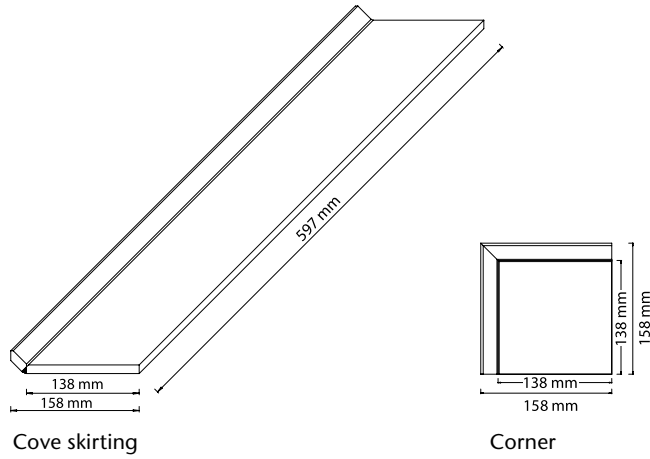

Scale 1:5

- 1 UW Silicone
- 2 Closed-cell PE foam cord or seperating foil
- 3 Water-resistant elastic filling material
- 4 Heat insulation, rigid foam
- 5 Footfall sound insulation, soft
- 6 Mortar / adhesive
- 7 Sliding layer, PE foil
- 8 Thin-bed laying on rendering
- 9 Base-bonded sealing layer
- 10 Solid backfill

Area Pro stair safety borders / stair tiles

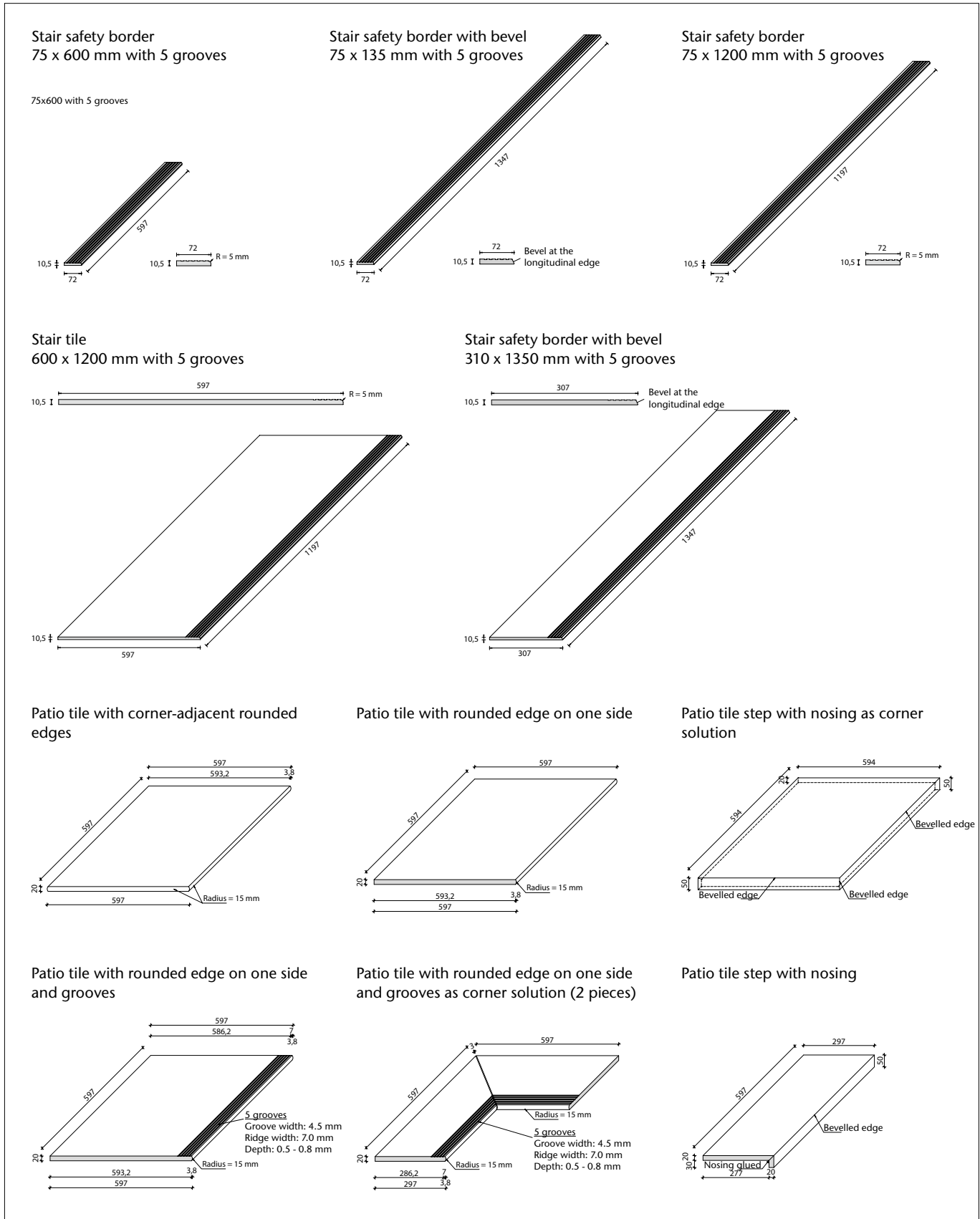

1. Construction Products Regulation (CPR)

The CPR distinguishes itself from the previous Construction Products Directive (CPD) above all by the Declaration of Performance, CE marking as well as assessment and verification of the constancy of performance of the product concerned.

Construction products brought into circulation after 1 July 2013 must comply with the CPR. "Bringing into circulation" means that a construction product is made available on the European market for the first time by the manufacturer. We would like to point out that the term of "provision" is delineated from that; it means the passing on of a construction product brought into circulation in the supply chain, e.g. from the specialist tile trade to end consumers.

Essential characteristics of a construction product – here ceramic tiles – are defined in Annex ZA of the harmonised standard DIN EN 14411.

2. CE marking

With the CE marking, the manufacturer indicates that it assumes responsibility for the conformity of the construction product with the performance stated in the Declaration of Performance as well as compliance with all relevant European legal regulations.

Furthermore, it is responsible for making sure that the CE marking is applied to the actual construction product, to a label or on the packaging. The CE marking is the sole conformity identification for all essential characteristics of a construction product. Additional marks may only be used for aspects which – in our case – are not regulated by DIN EN 14411.

3. Declaration of Performance

As of 1 July 2013, every manufacturer is obliged to establish a Declaration of Performance for each of its construction products. It thereby assumes responsibility for the conformity of the construction product with the declared performance. The Declaration of Performance replaces the former Declaration of Conformity.

The technical documentation of the manufacturer serves as basis for the Declaration of Performance. Among other things, it includes the results of the in-plant production controls such as e.g. initial tests.

The Declaration of Performance has to be provided with an arbitrary reference number by the manufacturer to which the CE marking refers, thus permitting unambiguous identification of the construction product.

The Declaration of Performance can be made available in printed or electronic form (e.g. by e-mail, CD or USB stick).

In addition, the Declarations of Performance for the construction products of Agrob Buchtal GmbH are to be found at www.agrob-buchtal.de/leistungserklaerung. Alternatively, you can scan this QR code:



Albania

POWATEC-AL sh.p.k.
Tel.: +355 4 2270731
Mobile: +355 69 2033095
E-mail: powatec@albmail.com

Australia

Ceramic Solutions (Aust) Pty Ltd.
Tel.: +61 3 95 45 53 22
E-mail: mail@ceramicsolutions.com.au
Internet: www.ceramicsolutions.com.au

Austria

Dipl. Ing. Silvia Lederer
Mobile: +43 664 30 76 68 6
E-mail: silvia.lederer@deutsche-steinzeug.de

Erwin Bauer

Mobile: +43 664 115 3558
E-mail: erwin.bauer@deutsche-steinzeug.de

Bahrain

Patric Kakoschky
Tel.: +49 94 35 3 91-34 47
Mobile: +49 160 7417906
E-mail: patric.kakoschky@deutsche-steinzeug.de

Baltic States

Nedas Bobinas
Tel.: +370 65 624217
E-mail: buchtal.baltic@gmail.com

Belgium

Johan Vanrompay
Mobile: +32 471 84 44 18
E-mail: johan.vanrompay@deutsche-steinzeug.de

Bosnia-Herzegovina

Lokar Zastopstva d.o.o.
Tel.: +386 15 61 21 63
E-mail: lokar.zastopstva-ds@siol.net

Bulgaria

Hristo Shterev
Mobile: +359 886 899 589
E-mail: hsterev@gmail.com

Canada

Eastern Canada
CERAGRES TILE GROUP INC.
E-mail: j.racine@ceragres.ca

Western Canada

V.P. Tile Imports
Tel.: +1 604 240 1760
E-mail: peter@vptile.ca

China

Jeffrey Lung - AGROB BUCHTAL GmbH
Shanghai Office
Tel.: +86 021 63 81 09 86
E-mail: jeffrey.lung@dsk-asia.com

Jeffrey Lung - AGROB BUCHTAL GmbH

Beijing Office
Tel.: +86 010 58 69 19 01
E-mail: jeffrey.lung@dsk-asia.com

Croatia

Lokar Zastopstva d.o.o.
Tel.: +386 15 61 21 63
E-mail: lokar.zastopstva-ds@siol.net

Cyprus

E.K.A. Ltd.
Tel.: +357 2 5 85 44 44
E-mail: mloizides@ekagroup.com

Czech Republic

Ceram Objekt s.r.o.
www.ceramobjekt.cz
Tel.: +420 2 71 74 17 414
E-mail: gciprianova@ceramobjekt.cz

Denmark

Torben Christensen
Tel.: +45 242 05 14 8
E-mail: buchtal@buchtal.dk

Egypt

Patric Kakoschky
Tel.: +49 94 35/3 91-34 47
Mobile: +49 160 7417906
E-mail: patric.kakoschky@deutsche-steinzeug.de

Finland

ABL Finland OY
Tel.: +358 9 3 50 87 00
E-mail: abl@abl.fi

France

Christophe Rodriguez
Deutsche Steinzeug France S.A.R.L.
Mobile: +33 6 40 94 34 32
E-mail: buchtal@buchtal.fr
Internet: www.agrob-buchtal.de

Great Britain

Rolf Klebl
Mobile: +49 160 74 28 839
E-mail: rolf.klebl@deutsche-steinzeug.de

Greece

Emco S.A.
Tel.: +30 210 6 13 83 10
E-mail: jbog@emco.gr

Hungary

Roland Fekete
Tel.: +36 96 51 70 17
E-mail: feketeroland@buchtal.hu

Iceland

Birgisson ehf
Tel.: +354 5160602
E-mail: egill@birgisson.is
Internet: www.birgisson.is

India

Patric Kakoschky
Tel.: +49 94 35 3 91-34 47
Mobile: +49 160 7417906
E-mail: patric.kakoschky@deutsche-steinzeug.de

Italy

Luigi Maresca
Tel.: +49 94 35 3 91-34 51
E-mail: luigi.maresca@deutsche-steinzeug.de

Japan

Rolf Klebl
Tel.: +49 94 35 3 91-33 26
Mobile: +49 160 742 88 39
E-mail: rolf.klebl@deutsche-steinzeug.de

Kosovo

Lokar Zastopstva d.o.o.
Tel.: +386 15 61 21 63
E-mail: lokar.zastopstva-ds@siol.net

Kuwait

Patric Kakoschky
Tel.: +49 94 35 3 91-34 47
Mobile: +49 160 7417906
E-mail: patric.kakoschky@deutsche-steinzeug.de

Lebanon

Patric Kakoschky
Tel.: +49 94 35 3 91-34 47
Mobile: +49 160 7417906
E-mail: patric.kakoschky@deutsche-steinzeug.de

Luxembourg

Philip Daelemans
Mobile: +32 495 30 33 03
E-mail: philip.daelemans@buchtal.be

Macedonia

Lokar Zastopstva d.o.o.
Tel.: +386 15 61 21 63
E-mail: lokar.zastopstva-ds@siol.net

Moldavia

Sabin Maghiar
Tel.: +40 743 45 29 58
E-mail: sabin.maghiar@deutsche-steinzeug.ro

Montenegro

Lokar Zastopstva d.o.o.
Tel.: +386 15 61 21 63
E-mail: lokar.zastopstva-ds@siol.net

Namibia

O. Behrens & Co. (PTY) Ltd., Windh.
Tel.: +264 61 23 83 00
E-mail: perstling@obeco.com.na

The Netherlands

Matthias Hansel
Mobile: +49 151 18213971
E-mail: matthias.hansel@deutsche-steinzeug.de

Norway

Stein M. Skogstad
Tel.: +47 66 77 94 98
Mobile: +47 91 39 52 08
E-mail: stein@agrob-buchtal.no

Poland

Rafal Butkiewicz
Tel.: +48 6 01 70 67 57
E-mail: biuro@agrob-buchtal.pl

Portugal

Lusomatec
Tel.: +351 915828266
E-mail: nuno.conceicao@lusomatec.pt
Internet: www.lusomatec.pt

Qatar

Patric Kakoschky
Tel.: +49 94 35 3 91-34 47
Mobile: +49 160 7417906
E-mail: patric.kakoschky@deutsche-steinzeug.de

Romania

Sabin Maghiar
Tel.: +40 743 45 29 58
E-mail: sabin.maghiar@deutsche-steinzeug.ro

Saudi Arabia

Patric Kakoschky
Tel.: +49 94 35 3 91-34 47
Mobile: +49 160 7417906
E-mail: patric.kakoschky@deutsche-steinzeug.de

Serbia

Lokar Zastopstva d.o.o.
Tel.: +386 15 61 21 63
E-mail: lokar.zastopstva-ds@siol.net

Slovakia

BUCHTAL SK, s.r.o.
Tel.: +421 2 44 25 03 69
E-mail: b.hauswald@agrob-buchtal.sk
Internet: www.agrob-buchtal.sk

Slovenia

Lokar Zastopstva d.o.o.
Tel.: +386 15 61 21 63
E-mail: lokar.zastopstva-ds@siol.net

South Africa (RSA)

Roger Skudder
Tel.: +27 16 362 16 17
E-mail: rskudder@global.co.za

Spain

Joaquín Prat Pérez-Nieves
Mobile: +34 607 923 470
E-mail: joaquin.prat@buchtal.es
Internet: www.buchtal.es

Sweden

Stein M. Skogstad
Tel.: +47 66 77 94 98
Mobile: +47 91 39 52 08
E-mail: stein@agrob-buchtal.no

Switzerland

Deutsche Steinzeug Schweiz AG
Tel.: +41 41 6 32 50 60
E-mail: info@deutsche-steinzeug.ch

Turkey

Patric Kakoschky
Tel.: +49 94 35 3 91-34 47
Mobile: +49 160 7417906
E-mail: patric.kakoschky@deutsche-steinzeug.de

UAE

Patric Kakoschky
Tel.: +49 94 35 3 91-34 47
Mobile: +49 160 7417906
E-mail: patric.kakoschky@deutsche-steinzeug.de

Ukraine

Andriy Horak
Tel.: +49 94 35 3 91-32 76
Mobile: +49 160 741 26 17
Fax: +49 94 35 3 91-30 32 76
E-mail: a.horak@deutsche-steinzeug.de

Sales management**Austria**

Robert Wölfler
Tel.: +43 664 1342659
E-mail: robert.woelfler@deutsche-steinzeug.de

Belgium, The Netherlands, Luxembourg

Richard van der Maaten
Mobile: +31 (0)621 478134
E-mail: richard.van-der-maaten@deutsche-steinzeug.de

Eastern Europe without Bulgaria, Poland and Romania

Markus Pavelic
Tel.: +49 94 35 3 91-3463
Mobile: +49 171 56 74 713

France, Spain, Portugal, Monaco, Andorra

Christophe Rodriguez
Mobile: +33 640 94 34 32
E-mail: christophe.rodriguez@deutsche-steinzeug.de

Korea, Taiwan, Hong Kong, Thailand, China, Japan, Singapore, Indonesia, The Philippines, Malaysia, Brunei, Vietnam, Myanmar, Laos, Cambodia

Jeffrey Lung
Mobile: +852 51 67 36 66
E-mail: jeffrey.lung@dsk-asia.com

Australia / New Zealand, Bulgaria, Cyprus, Egypt, Greece, India, Iran, Iraq, Libya, Middle East, Namibia, Poland, Romania, Sudan South Africa and Turkey

Patric Kakoschky
Tel.: +49 94 35 3 91-34 47
Mobile: +49 160 741 79 06
E-mail: patric.kakoschky@deutsche-steinzeug.de

Northern Europe, Baltic States, Canada, Great Britain, Ireland

Rolf Klebl
Tel.: +49 94 35 3 91-33 26
Mobile: +49 160 742 88 39
E-mail: rolf.klebl@deutsche-steinzeug.de

Italy

Virginio Quirci
Mobile: +39 (335) 5360808
E-mail: virginio.quirci@deutsche-steinzeug.de

Switzerland

Deutsche Steinzeug Schweiz AG
Renato Borsani
Tel.: +41 41 632 50 60
E-mail: renato.borsani@deutsche-steinzeug.ch

USA

DSA Deutsche Steinzeug America, Inc.
Tel.: +1 770 442 55
Fax: +1 770 442 55
Udo Reich
E-mail: udo.reich@agrob-buchtal.com
E-mail: udo.reich@drytilenorthamerica.com
E-mail: info@agrob-buchtal.com
Internet: www.agrob-buchtal.com

Latin America

Diego Chavez
Tel.: +591 76 34 04 22
E-mail: diego@buchtal.latam.com
Internet: www.gc latinoamerica.com

Project: Ilot de l'Octroi / Location: Rennes, France / Architect: MVRDV / Series: KeraTwin



R9 R10

R10/A R10/B

R10/A+B R11/B

These tiles have the respective slip-resistance class.



This tile is provided with Hytect.



PT

This tile is Protecta-coated.



This tile is rectified, i. e. it can be laid with particularly narrow joints.



Not or only limited acid and alkali resistant.



Rectified wall tiles with rounded, bevelled edges: no sharp-edged transitions/edges, irregularities displayed by the base can be easily compensated for, tiles can be laid very close together (1-2 mm joints)



Thermoplastically glued mosaics can be used without any problems in underwater areas (e.g. swimming pools/whirlpools) as well as in permanently wet areas (e.g. pool surrounds/showers).



This tile is frost-proof.



6 mm tile

V0

No variation / no play of colors

V1

Low variation / Low play of colors

V2

Medium variation / Medium play of colors

V3

High variation / High play of colors

V4

Strong variation / Strong play of colors

Color Shade Variation

"Color shade variation" refers to the variations in color between the tiles of a certain color, i.e. the degree of shading. Our products are classified into 5 shading coefficients.

Easy to find

Each individual series is always represented as follows:

- Color chart
- Short description
- Product specifications
- Luminance contrast

- 1 **Series name;** sort of material (see page 701) and relevant product standard (see page 702) next to it.
- 2 **Schematic arrangement of the models** from left to right: Standard models from small to large: in the case of extruded split tiles, at first rectangular and then square models from small to large, fittings/special pieces.
- 3 **Peculiarities** of the model
- 4 **Model number** (only in the case of extruded split tiles)
- 5 **Nominal dimensions** = work size + recommended joint width in centimetres and inches
Work size = only material dimensions without joint
- 6 **Surface quality** (only in the case of earthenware, stoneware and porcelain stoneware tiles)
- 7 Logistic **product specifications**
- 8 **Product standard**
- 9 **Slip-resistance classification:**
Barefoot areas/public and industrial areas (see page 708 and the following)
- 10 **Stress groups 1 – 5;** orientation help for the industrial and commercial sector (see page 703 and the following)
- 11 **Article number**
- 12 **Abrasion**
In the case of glazed materials according to stress groups 1-5; (see page 704).
- 13 **Designation** and/or **number of color**
- 14 **Price group** (pricing unit in brackets)

268

PLURAL NON-SLIP 1
stoneware

2 **Wall/Floor Tiles^{2/4}**

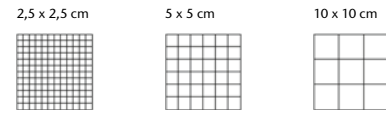

3 **Mosaic, glued thermoplastically on back** Sheet: 297 x 297 mm

5	Nom. dim. - cm/in	2.5 x 2.5 / 1 x 1	5 x 5 / 2 x 2	10 x 10 / 4 x 4
	Work size	23 x 23 x 6.5 mm	47 x 47 x 6.5 mm	97 x 97 x 6.5 mm
6	Surface	smooth, mat	smooth, mat	smooth, mat
	m ² - pieces	11 sheets	11 sheets	11 sheets
	m ² - kg	12.100	12.331	13.101
	Bundle - pieces	11 sheets	11 sheets	11 sheets
	Bundle - m ²	1.000	1.000	1.000
	Bundle - kg	12.100	12.331	13.101
	Pallet - m ²	48.000	64.000	64.000
	Pallet - kg	580.800	789.184	838.464
8	Product standard	Bib	Bib	Bib
	Slip resistance	R10/B	R10/B	R10/B
10	Stress group	1 - 2	1 - 2	1 - 2
	neutral 10	4	4	4
	(active white)	13	13	13
		11	14	
		Price gr. A216 (m ²)	Price gr. A169 (m ²)	Price gr. A157 (m ²)

The following symbols are used:

- Hytect surface (for description, refer to pages 10 and 707)
- Protecta surface upgrading (for description, refer to page 707)
- Novelties
- no shodfoot traffic
- Rectified
- Conically rectified
- Make-to-order production: cancellation not possible. This applies to all articles marked with this symbol, especially:
 - oblong formats
 - stair tiles
 - article numbers printed in italics
- Orientation aid for the blind
- Frost-resistant
- R9 Slip-resistant
- B Slip-resistant / Barefoot areas
- Made in Germany
- Glued thermoplastically
- also available in other colors
- 6 mm tile

AGROB BUCHTAL GmbH
Buchtal 1, D-92521 Schwarzenfeld
Tel.: +49 (0) 94 35-391-0
Fax: +49 (0) 94 35-391-34 52

E-Mail: info@agrob-buchtal.de
Internet: www.agrob-buchtal.de

02/2023, www.assenmacher.net



The publisher does not assume liability for misprints.
Color deviations when compared to the original products may occur as a result of printing.