



tempio<sup>®</sup> BAGUETTE

SUNSCREEN SYSTEMS | SISTEMA DE LAMAS CERÁMICAS



# TERRACOTTA & GLAZED SUNSCREENS

## PAREDES DE BAGUETE

# tempio®

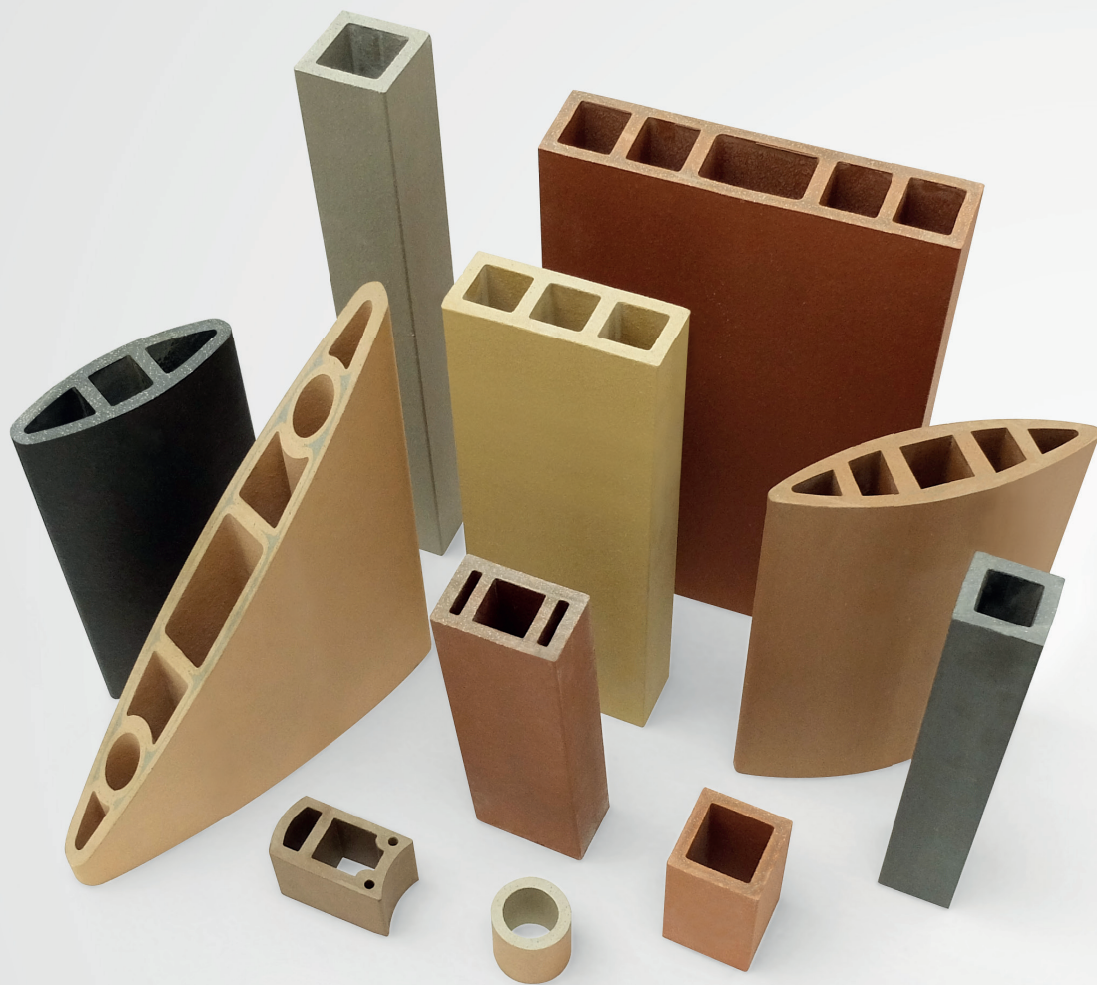

**Solar shading**  
Protección solar

**Horizontal and vertical element orientation**  
Orientación elemento horizontal y vertical

**Suitable for any building size**  
Apto para cualquier tamaño del edificio

**Venetian blind slats with Ceramics**  
Celosía con lamas de Cerámica

**Window sill and wall copings**  
Alfeizares de ventanas y coronación de paredes

**Profiles with hollow chambers**  
Perfiles con cámaras huecas

**Customized designed substructure**  
Subestructura especialmente diseñada

**Wide variety of terracotta colours and glazed colours with gloss or matt finish. On request, other finishing colors can be produced.**

Gran variedad de colores naturales y esmaltados brillo o mate. También fabricamos colores bajo demanda.

**Customized pieces**  
Piezas a medida

















## Advantages for façade in safety, comfort and aesthetics

Ventajas para fachada en seguridad confort y estética



### EXCELLENT ISOLATION PROTECCIÓN AISLANTE

-  **Energetic costs 25-40% reduction**  
\_ Reducción entre 25-40% del gasto energético
-  **Increased thermal and acoustic comfort**  
\_ Aumento del confort térmico y acústico
-  **No water condensation**  
\_ Eliminación del agua de condensación
-  **Waterproof building**  
\_ Impermeabilidad del edificio
-  **Passive ventilation**  
\_ Ventilación pasiva
-  **Thermal isolation**  
\_ Aislante térmico
-  **Double wall**  
\_ Doble pared

### SUSTAINABLE SOSTENIBLE

-  **0% wastewater discharged**  
\_ 0% de aguas residuales vertidas
-  **Low CO2 emissions**  
\_ Mínima emisión de CO<sub>2</sub>
-  **Waste material recycling**  
\_ Reciclaje del material sobrante

### LONG LIFE PRODUCT PRODUCTO DE LARGA VIDA

-  **Unalterable colours**  
\_ Colores inalterables al paso del tiempo
-  **Self-cleaning with rainwater**  
\_ Autolimpiable con agua de lluvia
-  **Time resistant**  
\_ Resistente al paso del tiempo

### REHABILITATION REHABILITACIÓN

-  **Direct application without creating debris**  
\_ Aplicación directa sin crear escombros
-  **Piece by piece replaceable system**  
\_ Sistema reemplazable pieza por pieza
-  **Revaluation of property**  
\_ Revalorización del inmueble
-  **Hidden conductions**  
\_ Paso de conducciones no vistas
-  **Hidden cracks and crevices**  
\_ Grietas ocultas









**PROJECT**  
Abercrombie Building  
University of Sydney Business School

**LOCATION**  
Darlington, Australia

**ARCHITECT**  
Woods Bagot/Kann Finch

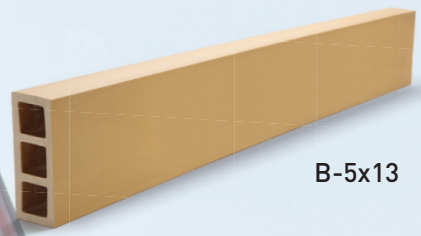

**CONTRACTOR**  
John Holland

**PIECE**

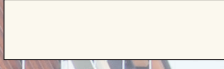
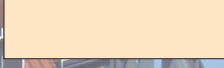
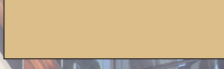

B-5x13

**COLOURS**

-  White Formentera EB3210
-  Blanco W2-07
-  Amarillo Y125-15
-  Rojo R05-05
-  Rojo R25-25









**PROJECT**  
Biological Science Building  
University Of New South Wales (UNSW)

**LOCATION**  
Sydney, Australia

**ARCHITECT**  
Woods Bagot, John Norman

**CONTRACTOR**  
Sharvain Projects

**PIECE**



FK-20



B-5x5  
B-6x25

**COLOURS**

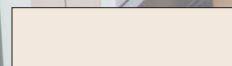

Blanco W00-20

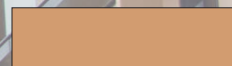

Naranja NA05-05



Rojo R15-10

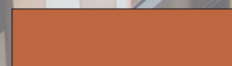

Rojo R25-19



Negro B5-10





**PROJECT**

UNSW University of new South Wales Sydney

**LOCATION**

FJMT Sydney (Mathew Todd & Janine Deshon)

**ARCHITECT**

Installation Company Yuanda

Construction Company Brookfield Multiplex

**CONTRACTOR**

John Holland

**PIECES**



FKL2-16/300



FBV1/24



BO-300x62

**COLOURS**

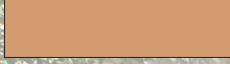

Orange NA05-15









PROJECT  
Kuntola School

LOCATION  
Järvenpää, Finland

ARCHITECT  
Kirsti Sivén & Asko Takala

PIECE

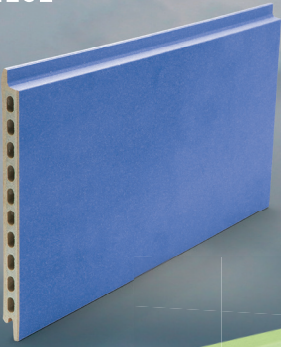

FS-20



B-5x13

COLOURS



Green Exeter EB3415

Green Glasgow EB3470



Violet Medellin EB3980



Blue Mediterraneo EB3360









PROJECT  
Doosan Leadership Institute

LOCATION  
Seoul, South Korea

ARCHITECT  
Park Gene, AI Architects

CONTRACTOR  
Sunpark

PIECE



FK-L1/16-400

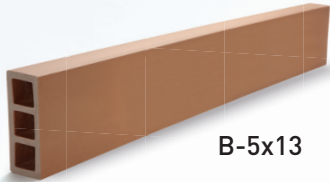

B-5x13

COLOURS



Marrón BR2-08

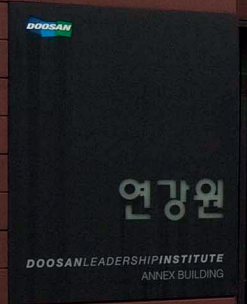







# tempio® BAGUETTE

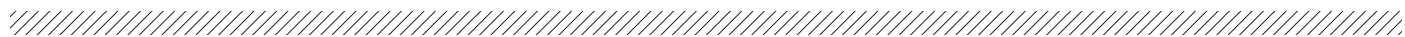

**B-d50**

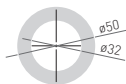

**B-5x5 curvo**

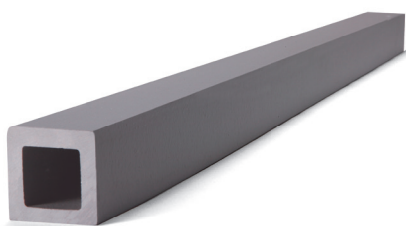
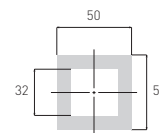

**B-5x5**

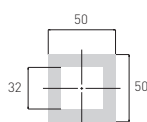

**B-6x6**

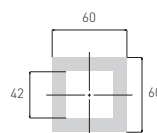

**B-7x7**

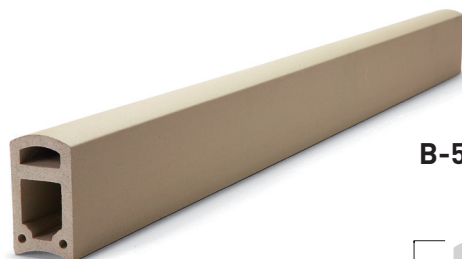
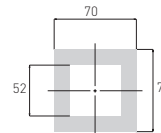

**B-5x8 r50**

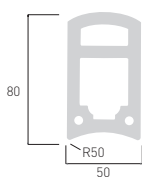

**B-5x8**

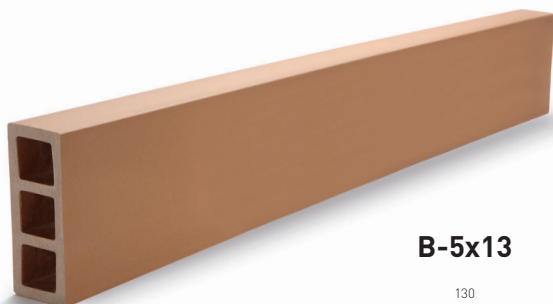
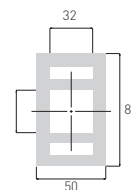

**B-5x13**

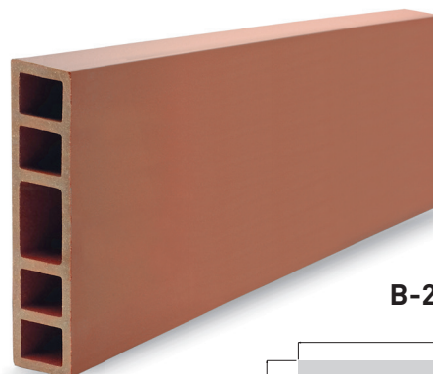
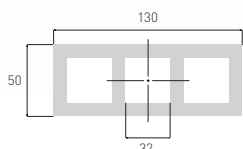

**B-250x60**

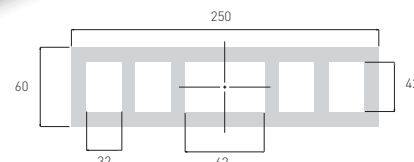



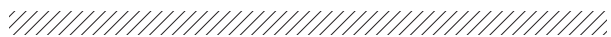

**BO-160x50**

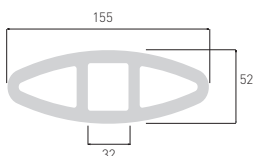

**BO-200x50**

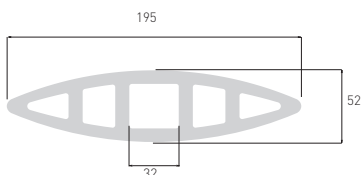

**BO-300x62**

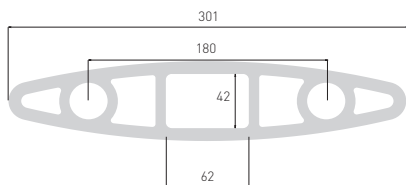

## Size guide Guía de medidas



piece / pieza	length piece largo pieza	weight / peso kg/m lineal
<b>B-d50</b>	< 1800 mm	2,5
<b>B-d110</b>	< 1500 mm	2,5
<b>B-5x5</b>	< 1800 mm	3,5
<b>B-6x6</b>	< 1800 mm	4
<b>B-7x7</b>	< 1800 mm	5
<b>B-5x5 curve</b>	< 600 mm	3,5
<b>B-5x8</b>	< 1800 mm	5,5
<b>B-5x8 r50</b>	< 1800 mm	5,5
<b>B-5x13</b>	< 1800 mm	7,7
<b>B-6X25</b>	< 1800 mm	15
<b>BO-5x16</b>	< 1500 mm	7,6
<b>BO-5x20</b>	< 1500 mm	9,7
<b>BO-6,2x30</b>	< 1500 mm	17,5

**Profiles with hollow chambers**  
Perfiles con cámaras huecas

**Specially designed substructure**  
Subestructura especialmente diseñada



## Special projects Proyectos especiales



**Made-to-measure on request**  
Fabricación a medida bajo demanda

**Special Cuts**  
Cortes especiales

**Colour development for projects**  
Desarrollo de colores especiales  
para proyectos





# SWING SYSTEMS

## HORIZONTAL SYSTEM



## VERTICAL SYSTEM

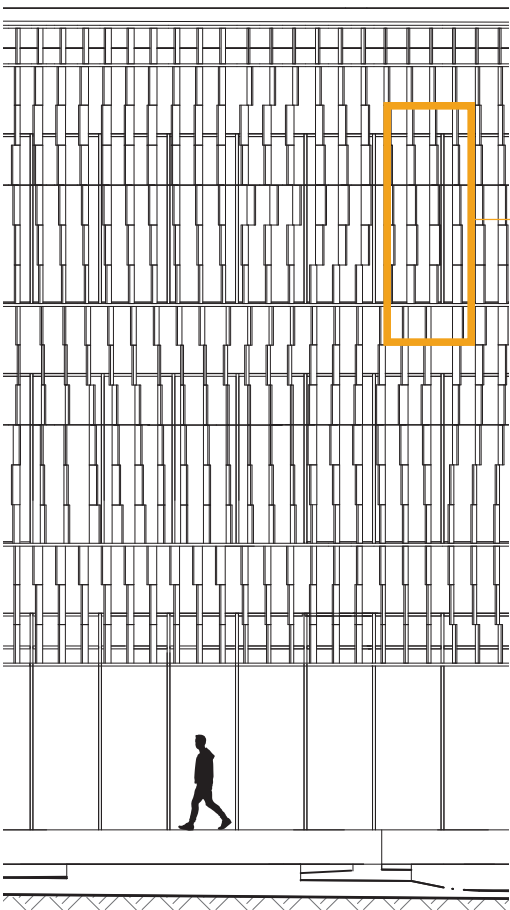

**Swing System**  
Sistema de giro

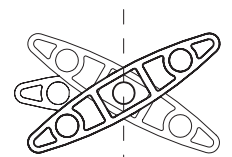
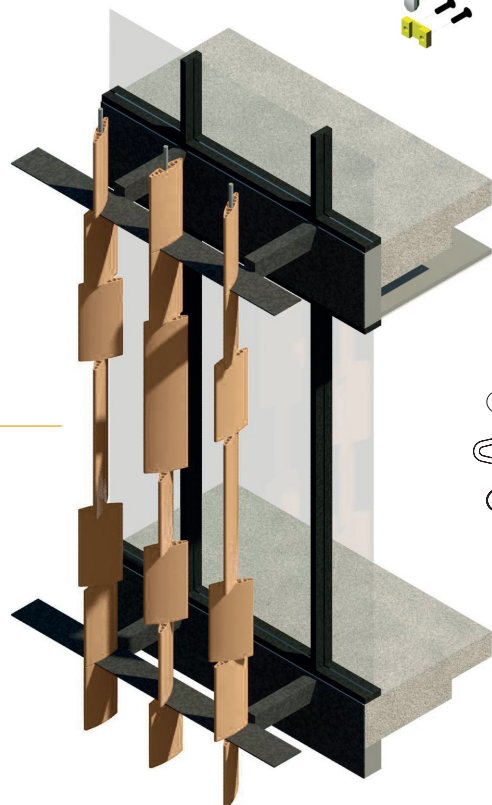
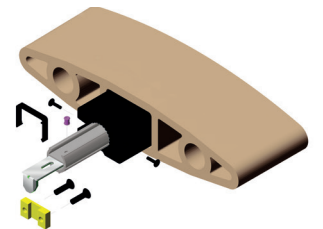







# tempio®

## Façade & sunscreen colour palette

Colores para fachada y baguette

**This is the chart of natural and enamel tones, matte and gloss, that we present. We can also create a custom color. We seek the homogeneity of the entire surface of each piece and of the entire façade. The quality of our ceramics makes it remain unchanged over the years or in environmental conditions.**

Esta es la carta de tonos naturales y esmaltados, mate y brillo, que presentamos. También podemos crear un color personalizado. Buscamos la homogeneidad de toda la superficie de cada pieza y del total de la fachada. La calidad de nuestra cerámica hace que permanezca inalterable con el paso de los años o las condiciones ambientales.

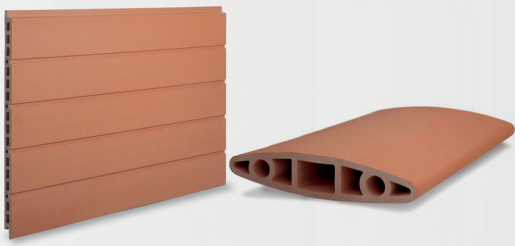

\*Colours may suffer variations in tone

\* Los colores pueden sufrir variaciones de tonalidad

### NATURAL





**MATT**  
**MATE**
**SATIN**  
**SATINADO**
**GLOSS**  
**BRILLO**

White Madrid EM2220

White Sevilla ES4220

White Formentera EB3210

Yellow Tanzania EB3660

Yellow Angola EB3680

White Palma EM2230

White Palma ES4230

White Palma EB3230

Red Murano EB3550

Violet Nicaragua EB3985

Marfil Barcelona EM2250

Marfil ES4250

Grey Foster EB3123

Violet Monterrey EB3950

Violet Guadalajara EB3990

Grey Foster EM2123

Grey Foster ES4123

Grey Arcadia EB3155

Blue Orinoco EB3370

Blue Nilo EB3390

Grey Arcadia EM2155

Grey Arcadia ES4155

Grey Princeton EB3182

Blue Volga EB3315

Green York EB3495

Grey Princeton EM2182

Grey Princeton ES4182

Black Columbia EB3187

Green Surrey EB3460

Green Leicester EB3480

Black Columbia EM2187

Black Columbia ES4187





Specially designed substructure  
Subestructura especialmente diseñada

## HORIZONTAL SYSTEMS

### ANCHOR PLATE SYSTEM

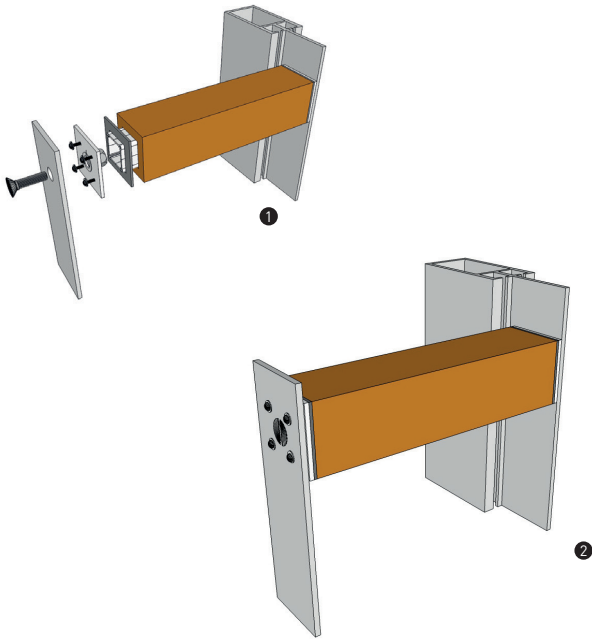

### STANDARD SYSTEM

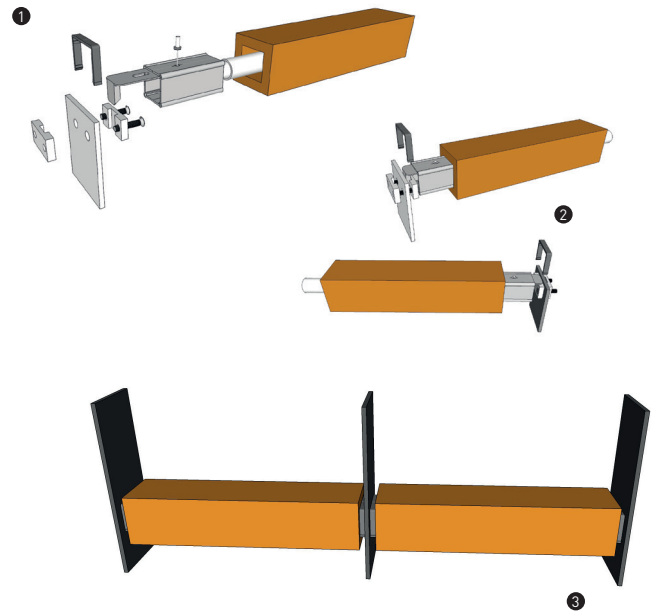

## VERTICAL SYSTEMS

### POP NUT SYSTEM

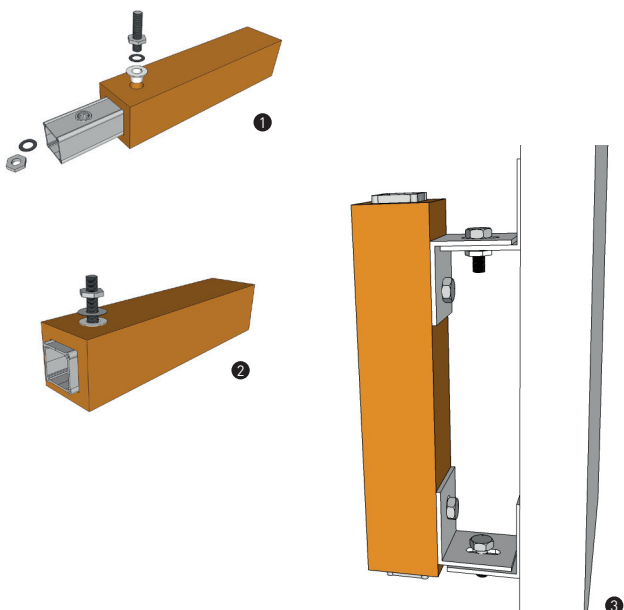

### HOOK SYSTEM

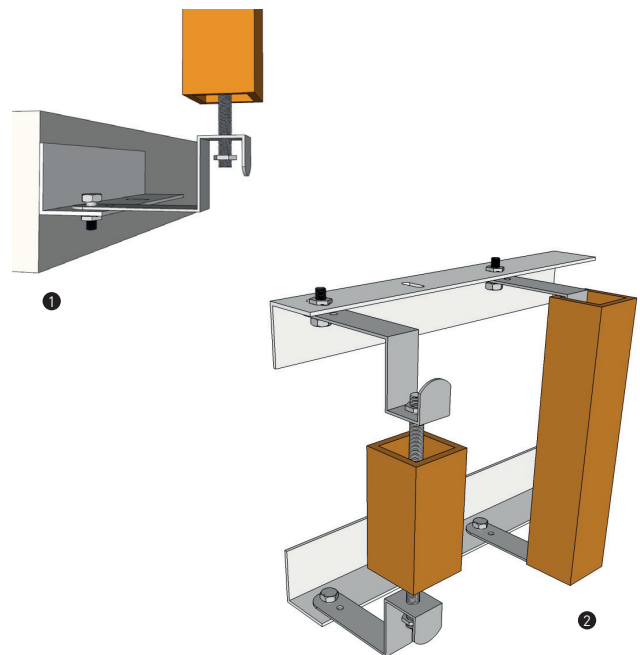







---

# INTERIOR & DESIGN

## INTERIORES Y DISEÑO

---

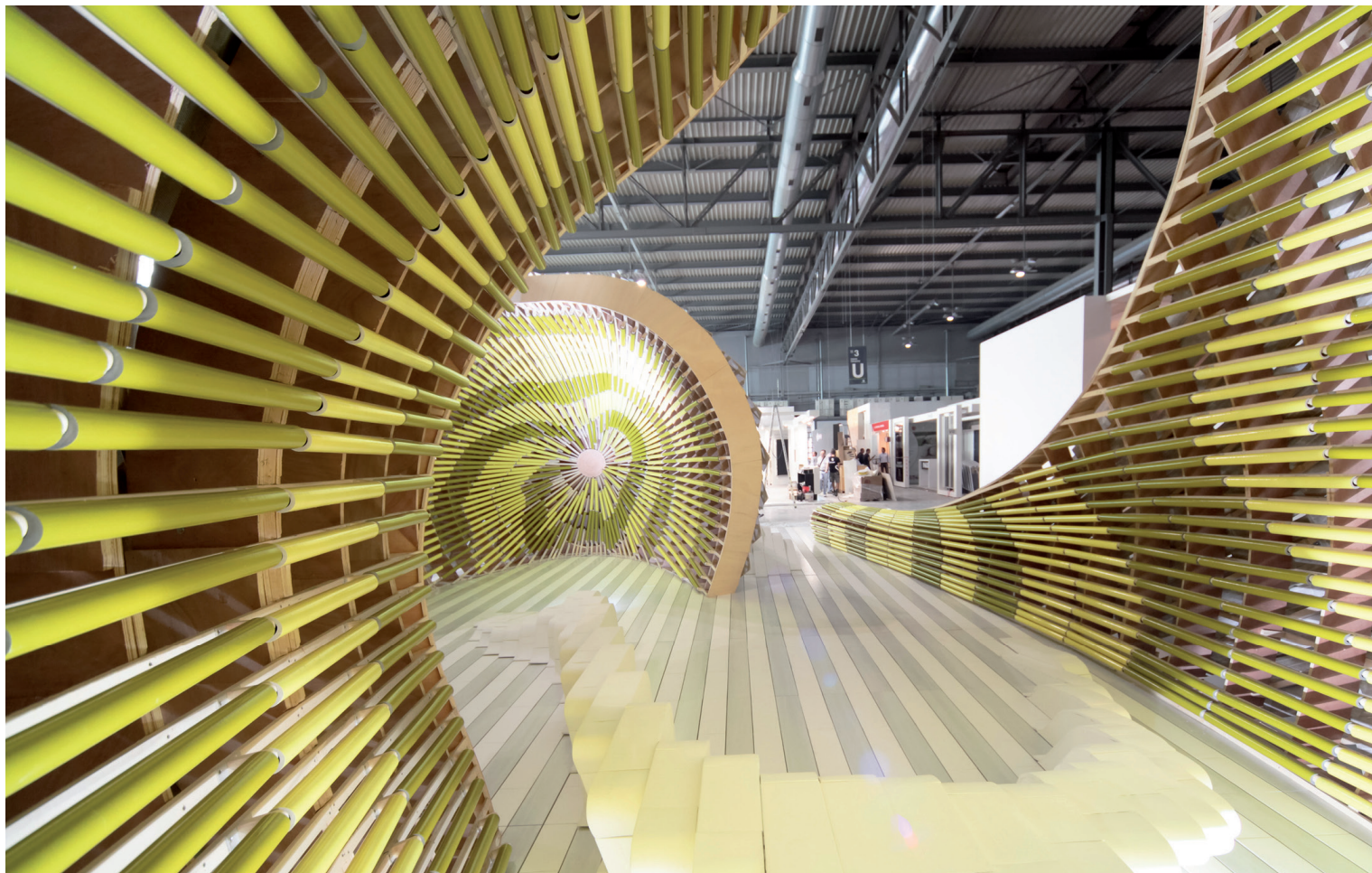

Fluidity Exhibition. Valencia, Spain.



**Ambient separation**  
Separación de ambientes

**Coating for interior walls and ceilings**  
Revestimiento de techos y paredes interiores

**Ephemeral architecture**  
Arquitectura efímera



# tempio®



Primavera Hotel. Benidorm, Spain.

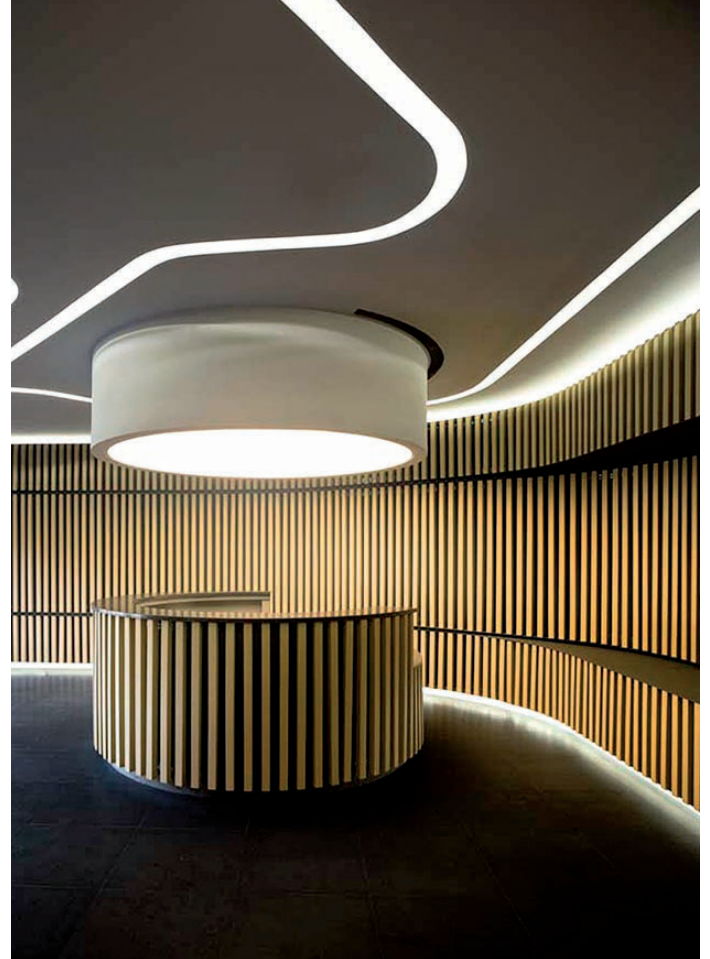

Príncipe de Vergara. Madrid, Spain.

UNSW University of new South Sales Sydney

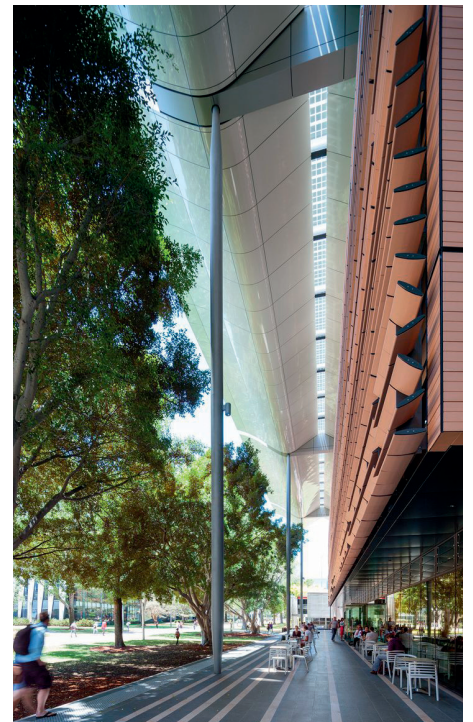



EDITION - APR'20

tempio®

CERÁMICA MAYOR, S.A.  
Partida Planet, s/n  
03510 Callosa d'En Sarrià  
(Alicante-España)

T+34 965 881 175  
[www.ceramicamayor.com](http://www.ceramicamayor.com)  
[www.tempio.es](http://www.tempio.es)

[www.tempio.es](http://www.tempio.es)