

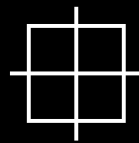

- 03 > **TECNO**
- 06 > **PORTFOLIO**
- 11 > **DESENHOS TÉCNICOS**
TECHNICAL DRAWINGS
- 14 > **CORES**
COLORS
- 16 > **ACESSÓRIOS**
FITTINGS
- 22 > **FICHA TÉCNICA**
TECHNICAL INFORMATION



CARACTERÍSTICAS
GEOMÉTRICAS
GEOMETRIC
CHARACTERISTICS
EN 1024



RESISTÊNCIA
MECÂNICA
FLEXURAL
STRENGTH
EN 538

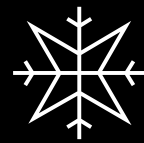

RESISTÊNCIA
AO GELO
FROST
RESISTANCE
EN 539-2



IMPERMEABILIDADE
IMPERMEABILITY
EN 539-1

A Tecno é a telha lusa de qualidade Premium da CS.

Tecno is the Premium quality brand of CS Portuguese roof tiles.

Concebida para oferecer a melhor solução em telha lusa e corresponder aos mais exigentes requisitos de estética e funcionalidade, a telha Tecno apresenta-se como a marca topo de gama da CS, no seu segmento.

Apresentando uma estanqueidade imbatível quando comparada com os convencionais modelos de telha lusa, a Tecno responde com a robustez e a resistência necessárias para fazer da cobertura cerâmica a opção certa, mesmo nas condições climáticas mais adversas.

Produzida utilizando a mais avançada tecnologia atualmente disponível, nomeadamente nos processos de prensagem e cozedura, a Tecno apresenta um sistema de frisos duplos perfeitamente definidos, altos e verticais, no seu topo e lateralmente, que lhe conferem a melhor estanqueidade.

Por este motivo, a telha Tecno é recomendada para coberturas com pendentes de inclinação inferior à normalmente possível com outras telhas lusas. O acabamento excecionalmente liso da superfície da telha realça a beleza do seu desenho e dificulta a fixação de fungos ou sujidade.

Designed to offer the best solution on Portuguese roof tile and match the most demanding requirements for aesthetics and functionality, Tecno presents itself as the CS premium brand in its segment.

Featuring an unbeatable tightness when compared to conventional Portuguese roof tiles models, Tecno responds with the necessary robustness and strength to make the ceramic covering the right choice, even in the most adverse weather conditions.

Produced using state-of-the-art technology, namely in pressing and firing processes, Tecno features, at its top and laterally, a system set of perfectly defined, high and vertical double ribs forming a labyrinthic that guarantees the best water tightness.

For this reason, Tecno is, therefore, the recommended choice for roofs with pitches lower than those usually used with other roman model roof tiles. The exceptionally smooth finishing of the roof tile surface enhances the beauty of its design and makes it difficult for the fungus or dirt to fix.

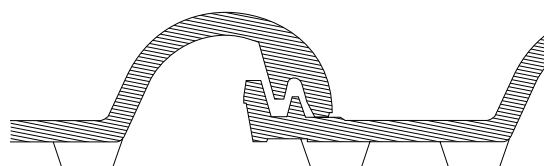
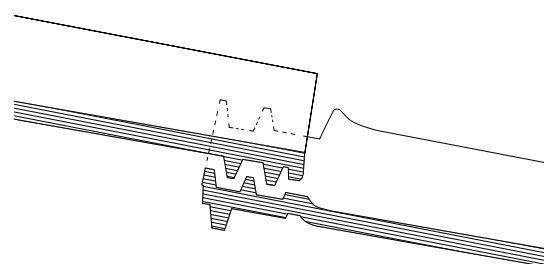

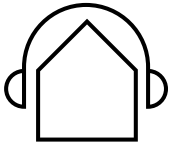

Isolamento acústico

O telhado proporciona uma barreira sonora, melhorando o conforto acústico e diminuindo o ruído no interior dos edifícios.

Sound insulation

The roof provides a sound barrier, improving comfort and reducing acoustic noise inside buildings.

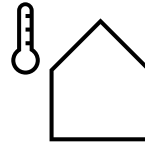

Isolamento térmico

O revestimento com telha cerâmica proporciona sombreamento à cobertura. Aliado ao efeito de ventilação, reduz significativamente o efeito térmico da exposição solar.

Thermal insulation

Clay roof tile provides shading to the buildings. Associated with ventilation, the clay roof tile covering significantly reduces the heating effect of sun exposure.



Apoio técnico

O serviço de apoio técnico ao aplicador, prestado por técnicos experientes, esclarece qualquer aspeto em fase de obra.

Technical support

Provided by experienced technical people, technical support to the applicator clarifies any doubt during the construction period.



Apoio a projetistas

Serviço de apoio ao projeto, cálculo de quantidades, identificação de acessórios e orçamentação. Além da disponibilização dos pormenores construtivos gerais para cada modelo de telha, auxilia e afere a sua integração no projeto.

Architects support

Service support for the project, calculation of quantities, fittings identification and budgeting. Beyond the provision of general construction details for each type of roof tile, this service assists and assesses its integration into the project.



Reaproveitamento de águas

A telha cerâmica é um produto de origem natural não tóxico, permitindo o aproveitamento de águas pluviais para os mais diversos fins.

Tank water safe

Clay roof tile is a non-toxic product with a natural origin, allowing the use of rainwater for multiple purposes.

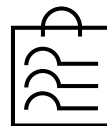

Minipacotes

Telhas agrupadas em minipacotes para permitir melhor acondicionamento e estabilidade na paleta e facilitar o transporte e o manuseamento na aplicação.

Minipacks

Assembled roof tiles in minipacks to enable better storage, pallet stability and facilitate transport and handling during application.



As elevadas temperaturas de cozedura a que a Tecno é sujeita garantem um nível ótimo de absorção de água, resistência mecânica excecional e conferem-lhe as caraterísticas físicas e químicas necessárias para assegurar o melhor comportamento face ao gelo.

A telha Tecno é produzida em pasta vermelha ou branca, podendo também ser acabada com engobes de alta qualidade, de cor uniforme ou matizada, numa gama de tons naturais acetinados.

The high firing temperatures to which Tecno is subjected guarantees an optimal level of water absorption, an exceptional mechanical resistance and the necessary physical and chemical characteristics to ensure the best behavior in presence of ice.

Tecno is produced in red or white clay, and it can be finished with high quality engobes, in uniform or shaded patterns, in a range of satin natural tones.



Tecno[®]

Portfolio



Casa Rebelo

**Praia da Areia Branca,
Portugal**

Projeto · Project

RBD.APP

**Rui Barreiros Duarte e
Ana Paula Pinheiro, Arqts.**

Produto · Product

**Tecno Vermelho Natural
Tecno Natural Red**

Quinta dos Sobreiros

Leiria, Portugal

Projeto · Project
João Camacho, Arq.

Produto · Product
Tecno Natural Rústico
Tecno Rustic Natural

Casa no campo de golfe da Aroeira

Setúbal, Portugal

Projeto · Project
Maria João Miranda,
Arqta.

Produto · Product
Tecno Branco Natural
Tecno Natural White





Normandy House

**Viana do Castelo,
Portugal**

Projeto · Project

**Autor desconhecido
Unknown author**

Produto · Product

**Tecno Vermelho 22
Tecno Red 22**





Moradia Mendes

Batalha, Portugal

Projeto · Project

Joaquim Duarte Duque,
Arq.

Produto · Product

Tecno Mediterrânico Rústico
Tecno Mediterranean Rustic

Desenhos Técnicos

Technical Drawings

- A** Vista isométrica da telha com abertura Ø250 mm
Isometric view of roof tile with opening Ø250 mm
- B** Vista isométrica da tampa
Isometric view of cap
- C** Corte transversal (solução com conduta de ventilação)
Transversal cut (ventilation duct solution)
- D** Corte longitudinal (solução com conduta de ventilação)
Longitudinal cut (ventilation duct solution)
- E** Corte transversal (solução tubo solar)
Transversal cut (solar tube solution)
- F** Corte longitudinal (solução tubo solar)
Longitudinal cut (solar tube solution)

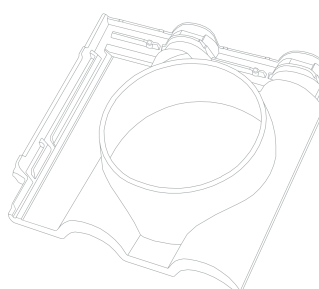

A



B

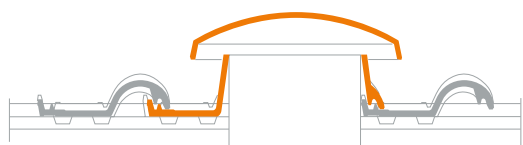

C

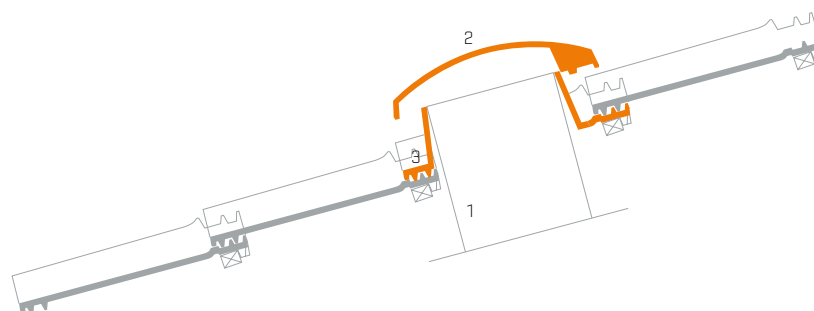

D

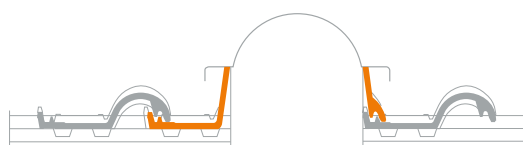

E

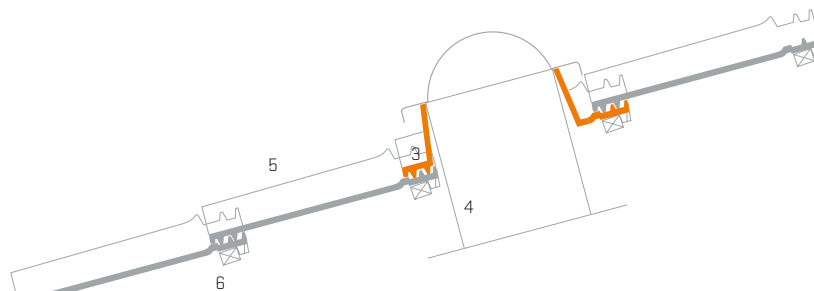

F

- | | |
|--|--|
| <ul style="list-style-type: none"> 1 Conduta de ventilação
Ventilation duct 2 Tampa para telha com abertura Ø250 mm
Cap for roof tile with opening Ø250 mm 3 Telha com abertura Ø250 mm
Roof tile with opening Ø250 mm 4 Tubo solar Ø250 mm
Solar tube Ø250 mm | <ul style="list-style-type: none"> 5 Telha Tecno
Tecno roof tile 6 Ripa de madeira
Wood batten |
|--|--|

G Cumeeira. Aplicação a seco
Ridge detail. Dry application

H Tampão de cumeeira
Ridge end cap

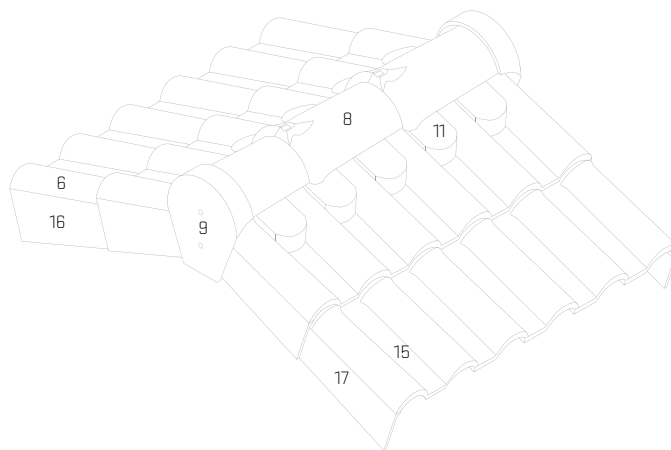
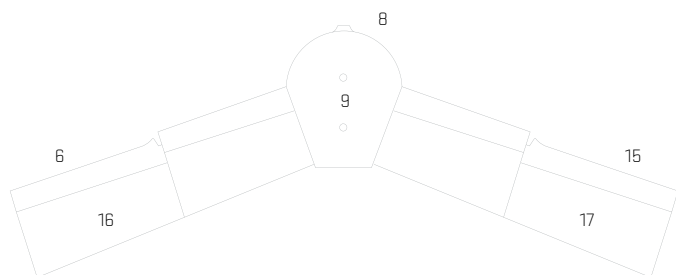
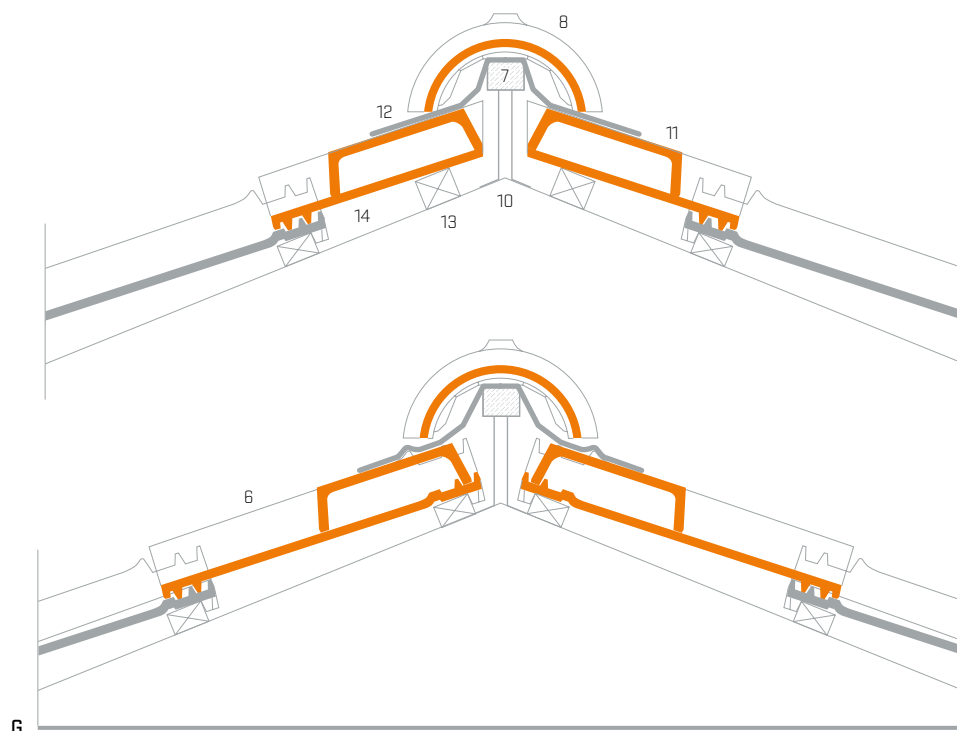

H

8 Telhão
Ridge tile

9 Tampão de cumeeira
Ridge end cap

10 Suporte de cumeeira
Ridge suport

11 Remate de cumeeira
Under-ridge wedge

12 Membrana em alumínio ventilada
Ridge and hip ventilation roll

13 Ripa de acerto
Levelling batten

14 Telha cortada
Cutted roof tile

15 Telha dupla
Double roof tile

16 Remate de empena direito
Gable rake right

17 Remate de empena esquerdo
Gable rake left

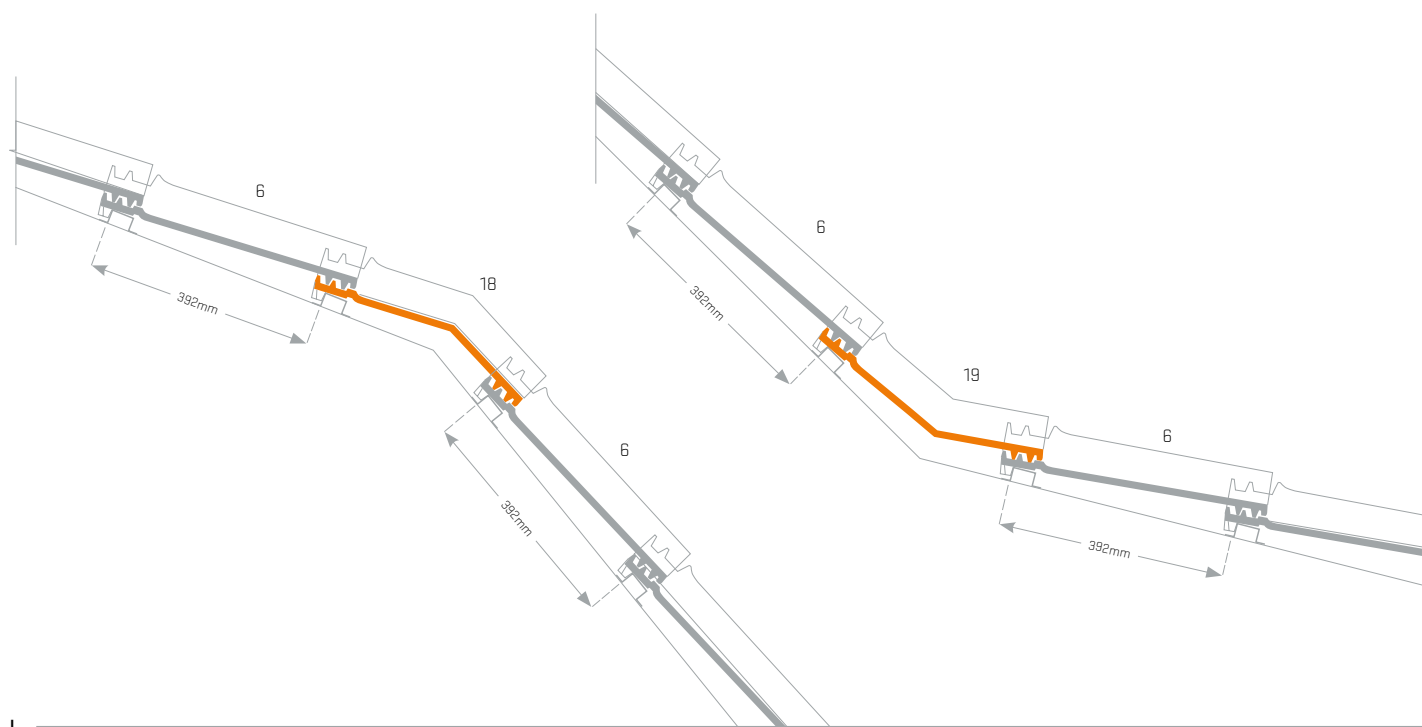

18 Telha de mansarda convexa Tecno
Tecno convex mansard roof tile

19 Telha de mansarda côncava Tecno
Tecno concave mansard roof tile

20 Meia telha
Half tile

I Telhas de mansarda, côncava e convexa
Mansard roof tiles, concave and convex

J Acabamento com telha dupla
Finishing with a double roof tile

K Acabamento com meia telha
Finishing with an half tile

L Simulação de montagem com telha dupla
Assembly simulation with a double roof tile

M Simulação de montagem com meia telha
Assembly simulation with an half tile

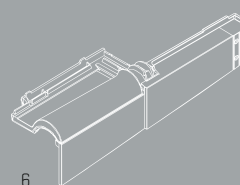
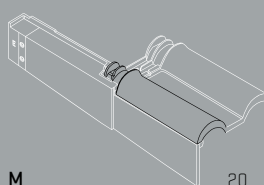
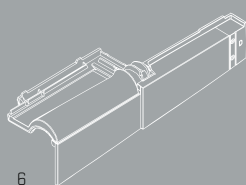
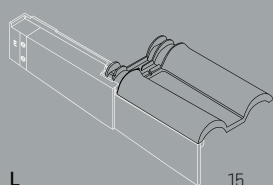
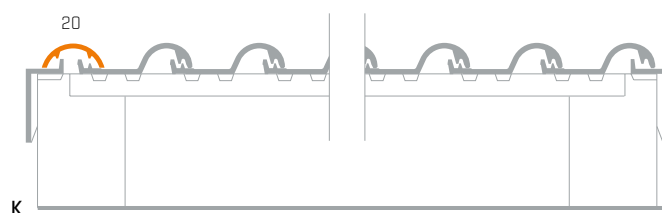
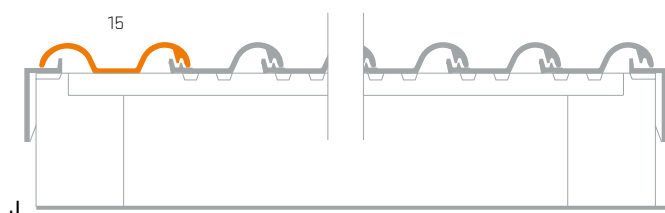

Cores

Colors

A reprodução das cores originais pode não ser garantida devido à qualidade da impressão.
As telhas cerâmicas provêm de matéria-prima natural e como tal apresentam variação de tonalidade. Durante a aplicação é aconselhável misturar telhas de diferentes paletes.

Printed colors may not be an exact match to the real colors of the products, due to print quality.
Clay roof tiles come from natural raw material and, as such, may have shade variations. During application it is advisable to mix roof tiles from different pallets.

N.00 Vermelho Natural
Natural Red



N.02 Branco Natural
Natural White



M.22 Vermelho
Red

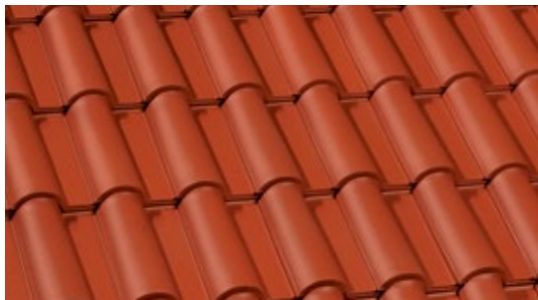

M.23 Titânio
Titanium



M.26 Mel
Honey



M.25 Castanho
Brown



E.40 Natural Rústico
Rustic Natural



E.41 Mediterrânico Rústico
Mediterranean Rustic



M.42 Vermelho Rústico
Rustic Red

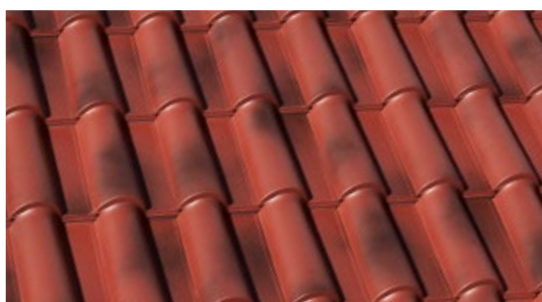

E.47 Rústico Antigo
Old Rustic



E.52 Europa
Europe



E.62 Nilo
Nile

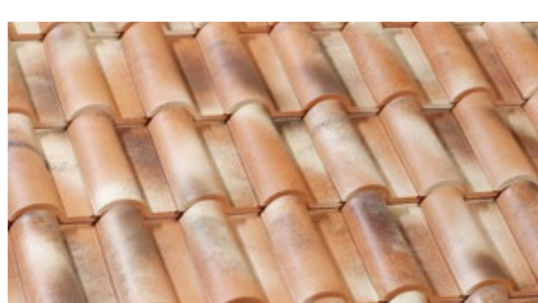

Acessórios

Fittings

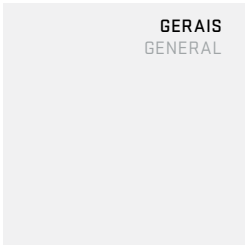

4 Meia telha
Half tile



5 Telha dupla
Double tile



9 Telha dupla 1/2 ripado*
Double 1/2 gauge tile*



10 Telha dupla 3/4 ripado*
Double 3/4 gauge tile*



14 Telha passadeira c/ventilação
Safety step and ventilation
tile



15 Telha passadeira
Safety step tile



1 Bacalhau
Valley end tile



2 Remate de empena dir.
Gable rake right



3 Remate de empena esq.
Gable rake left



6 Remate de caieira embebida
Imbedded gutter finish



7 Telha 1/2 ripado
1/2 gauge tile



8 Telha 3/4 ripado
3/4 gauge tile



11 Telha de beira
(sem frisos na face inferior)
Eave tile (without friezes on
the underside)



12 Telha dupla de beira
(sem frisos na face inferior)
Eave double tile (without
friezes on the underside)



13 Telha de ventilação
Ventilation tile



* Estes acessórios não se encontram disponíveis na cor Branco Natural N02
* These fittings are not available in Natural White color N02

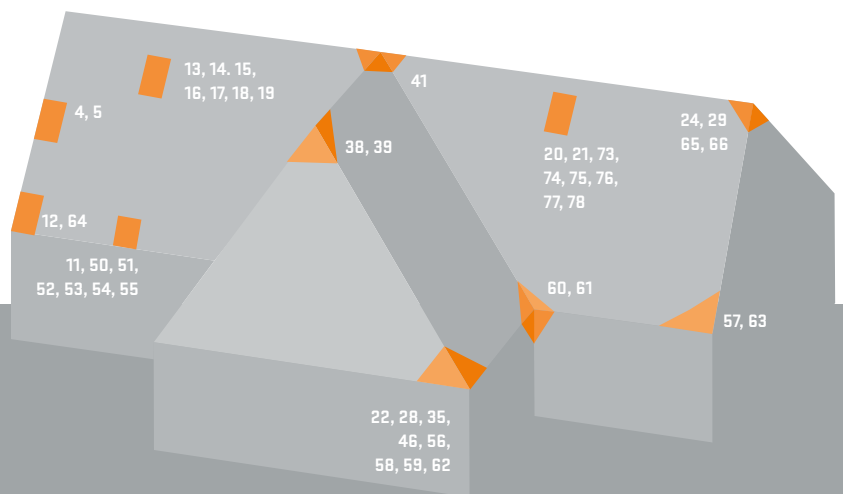

16 Telha passa tubos
Tube passage tile



17 Telha de topo plano
Flat top tile



18 Telha de vidro
Glass tile



19 Tecno Glas
Tecno Glas



20 Telha c/ abertura Ø250 mm
Roof tile with opening
Ø250 mm



21 Tampa p/ telha com
abertura Ø250 mm
Cap for roof tile with
opening Ø250 mm



22 Canto de beira (4 peças)
Eave corner (4 pieces)



**CUMEEIRAS
E RINCÕES**
RIDGES
AND HIPS

23 Remate de cumeeira
Under-ridge wedge



24 Tampão de cumeeira
universal
Universal ridge end cap



25 Telhão universal
Universal ridge tile



26 Telhão 3 hastes universal
Universal 3-way apex



27 Telhão 4 hastes universal
Universal 4-way apex



28 Telhão de início universal
Universal hip starter



29 Tampão de cumeeira
Ridge end cap



30 Telhão
Ridge tile



31 Telhão dir.
Ridge tile right

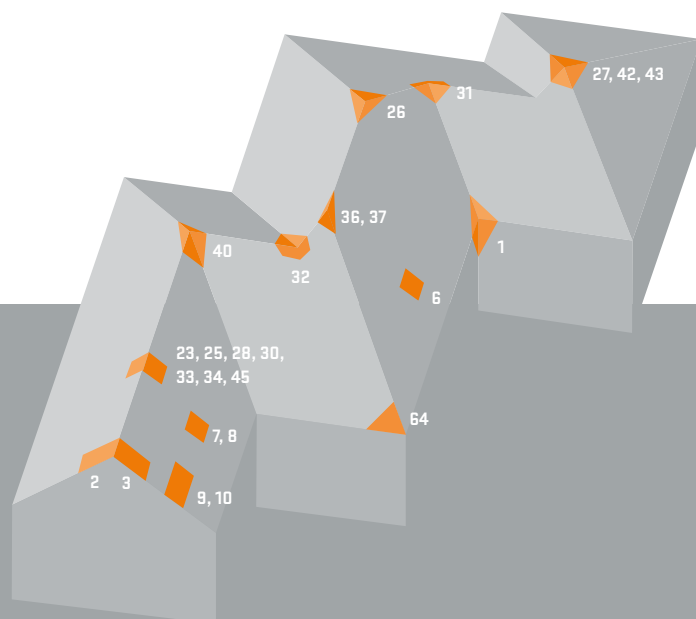

32 Telhão esq.
Ridge tile left



33 Telhão (macho)*
Ridge tile (male)*



34 Telhão (fêmea)*
Ridge tile (female)*



35 Telhão de início
Hip starter



36 Telhão de 3 hastes (macho)
3-way apex (male)



37 Telhão de 3 hastes (fêmea)
3-way apex (female)



38 Telhão de 3 hastes 60°
3-way apex 60°



39 Telhão de 3 hastes 120°
3-way apex 120°



40 Telhão de 3 hastes em L
3-way apex L-shaped



41 Telhão de 3 hastes em T
3-way apex T-shaped



42 Telhão de 4 hastes
4-way apex



43 Telhão de 4 hastes de torreão
4-way apex turret



44 Telhão de 4 hastes plano
4-way apex flat



45 Telhão estreito
Narrow ridge tile



46 Telhão de início estreito
Narrow hip starter



47 Telhão de 8 hastes*¹
8-way apex*¹



48 Telhão de 8 hastes de torreão*¹
8-way apex turret*¹

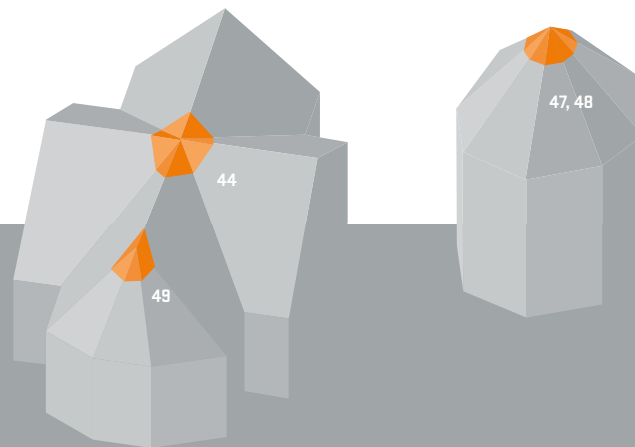

49 Telhão PG de 5 hastes
5-way PG apex



BEIRADO
CURVED FINISH EAVE

50 Bica 40
Eave under piece 40



51 Capa 40
Eave over piece 40



52 Bica 49*
Eave under piece 49*



53 Capa 49*
Eave over piece 49*



54 Bica 65*
Eave under piece 65*



55 Capa 65*
Eave over piece 65*



56 Canto de beirado 40
(8 peças)
Curved finish eave corner
40 (8 pieces)



57 Canto de beirado 40
(11 peças)
Curved finish eave corner
40 (11 pieces)



58 Canto de beirado 49
(11 peças)*
Curved finish eave corner
49 (11 pieces)*



59 Canto de beirado 65
(11 peças)*
Curved finish eave corner
65 (11 pieces)*



60 Canto recolhido de beirado
49 (9 peças)*
Curved finish eave inner
corner 49 (9 pieces)*



61 Canto recolhido de beirado
40 (5 peças)
Curved finish eave inner
corner 40 (5 pieces)



62 Telhão de início de beirado
Curved finish eave hip
starter



63 Telhão de início de
beirado dir.
Curved finish eave hip
starter right



64 Telhão de início de
beirado esq.
Curved finish eave hip
starter left



65 Telhão de 3 hastes de
empena (macho)
3-way gable apex (male)



66 Telhão de 3 hastes de
empena (fêmea)
3-way gable apex (female)



* Estes acessórios não se encontram disponíveis na cor Branco Natural N02
* These fittings are not available in Natural White color N02

*¹ Utilizar com telhão estreito
*¹ Use with narrow ridge tile

MANSARDA
MANSARD

67 Telha de mansarda cônica
Concave mansard tile



68 Telha de mansarda convexa
Convex mansard tile



69 Telhão de mansarda universal convexo
Universal convex mansard ridge tile



70 Telhão de mansarda universal cônica
Universal concave mansard ridge tile



71 Telhão de mansarda convexo
Convex mansard ridge tile



72 Telhão de mansarda cônica
Concave mansard ridge tile



CHAMINÉ
CHIMNEY

73 Base de chaminé Ø125 mm
Chimney support tile Ø125 mm



74 Base de chaminé Ø150 mm
Chimney support tile Ø150 mm



75 Chaminé
Ø125/Ø150 x 200/450 mm
Chimney
Ø125/Ø150 x 200/450 mm



76 Ângulo de chaminé
Ø 125mm *
Chimney angle
Ø 125mm *

NOVO
NEW



77 Tampa de chaminé A
Ø125/Ø150 mm
Chimney cap A
Ø125/Ø150 mm



78 Tampa de chaminé B
Ø125/Ø150 mm
Chimney cap B
Ø125/Ø150 mm



79 Tampa de chaminé C
Ø125/Ø150 mm
Chimney cap C
Ø125/Ø150 mm



DECORATIVOS
ORNAMENTAL

Pirâmide de bola
Ball pyramid



Pirâmide fina
Fine pyramid



Pirâmide de gomos
Buds pyramid



Pirâmide gorda
Hefty pyramid



* Ângulo de chaminé Ø 125mm
* Chimney angle Ø 125mm

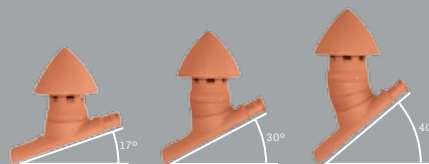

Pombo I / II
Pigeon I / II



Rola
Turtle dove



Setas (grande e pequena)
Arrows (large and small)



COMPLEMENTARES
COMPLEMENTARY

Grampos
Clips



Membrana em alumínio
multiusos
Aluminium flashing tape



Membrana em alumínio
ventilada
Ridge and hip ventilation roll



Pente tapa-pássaros
Eave ventilation comb



Suporte de cumeeira
Ridge support



Anilha
Washer



Parafuso autoperfurante
Self-drilling screw



Parafuso autorroscante
Self tapping screw

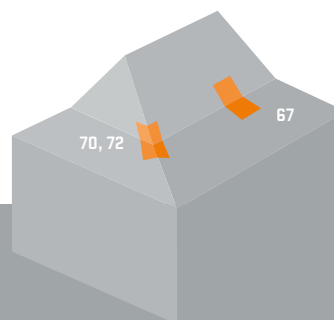
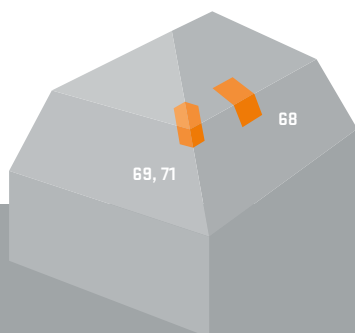



Norma aplicável: EN 1304

Telhas cerâmicas para colocação descontínua. Definições e especificações dos produtos.

Applicable norm: EN 1304

Clay roofing tiles for discontinuous laying. Product definitions and specifications.

Ensaio Test	Norma de aplicação Applicable standard	Requisitos da norma Standard requirements	
 Resistência mecânica Flexural strength	EN 538	Resistência $\geq 1200N$ Resistance $> 1200N$	Cumpre Accomplish
 Impermeabilidade Impermeability	EN 539-1	(Método 2) Categoria 1 (Method 2) Category 1	Cumpre Accomplish
 Resistência ao gelo Frost resistance	EN 539-2	Método de ensaio único Europeu Resistente - Nível 1 (≥ 150 ciclos) European single test method Resistant - Level 1 (≥ 150 cycles)	Cumpre Accomplish
 Características geométricas Geometric characteristics	EN 1024	Planaridade $\leq 1,5\%$ Planarity $\leq 1.5\%$ Retilnearidade $\leq 1,5\%$ Rectilinearity $\leq 1.5\%$	Cumpre Accomplish Cumpre Accomplish



Dimensões da telha (aprox.):
Roof tile dimensions (approx.):

Branco Natural
Natural White
465 x 257 mm
Outras cores
Other colors
464 x 258 mm

Peso da telha (aprox.):
Roof tile weight (approx.):

Branco Natural
Natural White
3,550 kg
Outras cores
Other colors
3,900 kg

Telhas por m² (aprox.):
Roof tiles per m² (approx.):

12

Medida do ripado (aprox.):
Gauge dimensions (approx.):

Branco Natural
Natural White
39,5 cm
Outras cores
Other colors
39,4 cm

Telhas por minipacote:
Roof tiles per minipack:

4

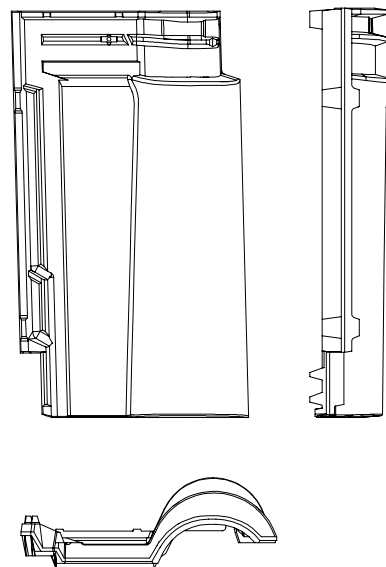

CS Coelho da Silva, SA

Albergaria, 2480-071 Juncal, Portugal

fax +351.244 479 201

www.coelhodasilva.com / www.cs-rooftiles.com

info@coelhodasilva.com



info CS
+351.244 479 200



CERAMICS®
Portugal does it better

